



**ROHDE & SCHWARZ**

Test and Measurement  
Division

## Operating Manual

# SIGNAL GENERATOR

## **SME02**

1038.6002.02

## **SME03**

1038.6002.03

## **SME03E**

1038.6002.13

## **SME03A**

1038.6002.53

## **SME06**

1038.6002.06

Printed in the Federal  
Republic of Germany



## Tabbed Divider Overview

Certificate of quality  
List of R & S Representatives  
Safety Instructions

**Contents**

**Data Sheet**

**EC Certificate of Conformity**

**Tabbed Divider**

<b>1</b>	<b>Chapter 1: Preparation for Use</b>
<b>2</b>	<b>Chapter 2: Manual Operation</b>
<b>3</b>	<b>Chapter 3: Remote Control</b>
<b>4</b>	<b>Chapter 4: Maintenance</b>
<b>5</b>	<b>Chapter 5: Performance Test</b>
<b>6</b>	<b>Annex A: Interfaces</b>
<b>7</b>	<b>Annex B: List of Error Messages</b>
<b>8</b>	<b>Annex C: List of Commands</b>
<b>9</b>	<b>Annex D: Programming Example</b>
<b>10</b>	<b>Index</b>



# Contents

<b>1</b>	<b>Preparation for Use .....</b>	<b>1.1</b>
<b>1.1</b>	<b>Putting into Operation.....</b>	<b>1.1</b>
1.1.1	Supply Voltage .....	1.1
1.1.2	Switching On/Off the Instrument.....	1.1
1.1.3	Initial Status .....	1.2
1.1.4	Setting Contrast and Brightness of the Display .....	1.2
1.1.5	RAM With Battery Back-Up .....	1.2
1.1.6	Preset Setting .....	1.3
<b>1.2</b>	<b>Functional Test.....</b>	<b>1.3</b>
<b>1.3</b>	<b>Fitting the Options.....</b>	<b>1.4</b>
1.3.1	Opening the Casing .....	1.4
1.3.2	Overview of the Slots .....	1.5
1.3.3	Option SM-B1 - Reference Oscillator OCXO.....	1.5
1.3.4	Option SM-B2 - LF Generator.....	1.6
1.3.5	Options SM-B3, SM-B8 and SM-B9 - Pulse Modulator 1.5, 3 and 6 GHz .....	1.7
1.3.6	Option SM-B4 - Pulse Generator .....	1.7
1.3.7	Option SM-B5 - FM/PM Modulator.....	1.7
1.3.8	Option SM-B6 - Multifunction Generator.....	1.9
1.3.9	Option SME-B11 - DM-Coder .....	1.9
1.3.10	Option SME-B12 - DM Memory Extension .....	1.11
1.3.11	Option SME-B19 - Rear Panel Connections for RF and LF .....	1.11
1.3.12	Options SME-B41 - FLEX Protocol - and SME-B42 - POCSAG .....	1.11
1.3.13	Cabling of the 50-MHz Reference (REF50).....	1.12
<b>1.4</b>	<b>Mounting into a 19" Rack .....</b>	<b>1.12</b>
<b>2</b>	<b>Operation .....</b>	<b>2.1</b>
<b>2.1</b>	<b>Explanation of Front and Rear Panel.....</b>	<b>2.1</b>
2.1.1	Elements of the Front Panel .....	2.1
2.1.1.1	Display .....	2.1
2.1.1.2	Controls .....	2.3
2.1.1.3	Inputs/Outputs .....	2.11
2.1.2	Elements of the Rear Panel.....	2.13
<b>2.2</b>	<b>Operating Concept .....</b>	<b>2.18</b>
2.2.1	Display .....	2.18
2.2.3	Basic Operating Steps .....	2.19
2.2.3.1	Calling the Menus.....	2.19
2.2.3.2	Selection and Change of Parameters .....	2.20
2.2.3.3	Triggering Action .....	2.21
2.2.3.4	Quick Selection of Menu (QUICK SELECT).....	2.21
2.2.3.5	Use of [FREQ] and [LEVEL] Keys .....	2.22
2.2.3.6	Use of [RF ON / OFF] and [MOD ON / OFF] Keys.....	2.22
2.2.3.7	Changing Unit of Level .....	2.22

2.2.3.8	Correction of Input.....	2.23
2.2.4	Sample Setting for First Users.....	2.23
2.2.4	List Editor.....	2.28
2.2.4.1	Select and Generate - SELECT LIST.....	2.29
2.2.4.2	Deletion of Lists - DELETE LIST.....	2.30
2.2.4.3	Edition of Lists.....	2.31
2.2.4.4	Pattern Setting to Operate the List Editor.....	2.35
2.2.5	Save/Recall - Storing/Calling of Instrument Settings.....	2.39
<b>2.3</b>	<b>Menu Summary.....</b>	<b>2.40</b>
<b>2.4</b>	<b>RF Frequency.....</b>	<b>2.41</b>
2.4.1	Frequency Offset.....	2.42
<b>2.5</b>	<b>RF Level.....</b>	<b>2.43</b>
2.5.1	Level Offset.....	2.45
2.5.2	Interrupt-free Level Setting.....	2.45
2.5.3	Switching On/Off Internal Level Control.....	2.46
2.5.4	Internal Level Control - Bandwidth Selection.....	2.47
2.5.5	User Correction (UCOR).....	2.47
2.5.6	EMF.....	2.49
2.5.7	[RF ON / OFF]-Key.....	2.49
2.5.8	Reset Overload Protection (only SME02 and SME03).....	2.49
<b>2.6</b>	<b>Modulation.....</b>	<b>2.50</b>
2.6.1	Modulation Sources.....	2.50
2.6.1.1	Simultaneous Modulation.....	2.51
2.6.1.2	Alternate Switching Off of Modulations.....	2.51
2.6.1.3	[MOD ON/OFF] Key.....	2.52
2.6.2	Analog Modulation.....	2.53
2.6.2.1	LF-Generator.....	2.53
2.6.2.2	Amplitude Modulation.....	2.54
2.6.2.3	Frequency Modulation.....	2.56
2.6.2.3.1	FM Deviation Limits.....	2.57
2.6.2.3.2	Preemphasis.....	2.57
2.6.2.4	Phase Modulation.....	2.58
2.6.2.4.1	PM Deviation Limits.....	2.59
2.6.2.5	Pulse Modulation.....	2.60
2.6.2.5.1	Pulse Generator.....	2.60
2.6.2.6	Stereo Modulation.....	2.63
2.6.2.7	VOR- / ILS-Test Signals.....	2.64
2.6.2.7.1	VOR Modulation.....	2.65
2.6.2.7.2	ILS-Glide Slope Modulation (ILS-GS).....	2.68
2.6.2.7.3	ILS-Localizer Modulation (ILS-LOC).....	2.72
2.6.2.7.4	Marker Beacon.....	2.76
2.6.3	Digital Modulation.....	2.78
2.6.3.1	Data Generator.....	2.79
2.6.3.2	PRBS Generator.....	2.80
2.6.3.3	DM Memory Extension, Option SME-B12.....	2.81
2.6.3.3.1	Recording a Data Sequence from an External Source.....	2.84
2.6.3.4	External Data Sources.....	2.86
2.6.3.5	GMSK Modulation.....	2.87
2.6.3.6	GFSK Modulation.....	2.89
2.6.3.7	QPSK Modulation.....	2.91

2.6.3.8	FSK Modulation .....	2.94
2.6.3.9	4FSK Modulation .....	2.97
2.6.3.10	FFSK Modulation.....	2.100
2.6.3.11	Radiocommunication Service ERMES .....	2.102
2.6.3.12	Radiocommunication Service FLEX.....	2.107
2.6.3.13	Radiocommunication Service ReFLEX25 .....	2.116
2.6.3.14	Radiocommunication Service POCSAG .....	2.127
<b>2.7</b>	<b>LF-Output .....</b>	<b>2.132</b>
<b>2.8</b>	<b>Sweep .....</b>	<b>2.134</b>
2.8.1	Setting the Sweep Range (START, STOP, CENTER and SPAN) .....	2.134
2.8.2	Selecting the Sweep Run (SPACING LIN, LOG).....	2.135
2.8.3	Operating Modes (MODE) .....	2.135
2.8.4	Trigger Input .....	2.136
2.8.5	Sweep Outputs .....	2.136
2.8.6	RF-Sweep.....	2.138
2.8.7	LEVEL Sweep.....	2.140
2.8.8	LF-Sweep.....	2.141
<b>2.9</b>	<b>LIST Mode .....</b>	<b>2.143</b>
2.9.1	Operating Modes (MODE) .....	2.143
2.9.2	Inputs/Outputs .....	2.144
<b>2.10</b>	<b>Memory Sequence.....</b>	<b>2.148</b>
<b>2.11</b>	<b>Utilities.....</b>	<b>2.152</b>
2.11.1	IEC-Bus Address (SYSTEM-GPIB) .....	2.152
2.11.2	Parameter of the RS232 Interface (SYSTEM-RS232) .....	2.153
2.11.3	Suppressing Indications and Deleting Memories (SYSTEM-SECURITY).....	2.154
2.11.4	Indication of the IEC-Bus Language (LANGUAGE).....	2.155
2.11.5	Reference Frequency Internal/External (REF OSC).....	2.155
2.11.6	Phase of the Output Signal (PHASE) .....	2.156
2.11.7	Password Input With Functions Protected (PROTECT).....	2.157
2.11.8	Calibration (CALIB).....	2.158
2.11.9	Indications of Module Variants (DIAG-CONFIG) .....	2.162
2.11.10	Voltage Indication of Test Points (DIAG-TPOINT) .....	2.163
2.11.11	Indications of Service Data (DIAG-PARAM).....	2.164
2.11.12	Test (TEST) .....	2.164
2.11.13	Assigning Modulations to the [MOD ON/OFF] Key (MOD-KEY).....	2.165
2.11.14	Setting Auxiliary Inputs/Outputs (AUX-I / O).....	2.166
2.11.15	Switching On/Off Beeper (BEEPER) .....	2.167
2.11.16	Installation of Software Option.....	2.168
<b>2.12</b>	<b>The Help System.....</b>	<b>2.169</b>
<b>2.13</b>	<b>Status.....</b>	<b>2.169</b>
<b>2.14</b>	<b>Error Messages.....</b>	<b>2.170</b>

<b>3</b>	<b>Remote Control.....</b>	<b>3.1</b>
<b>3.1</b>	<b>Introduction.....</b>	<b>3.1</b>
<b>3.2</b>	<b>Brief Instructions.....</b>	<b>3.1</b>
3.2.1	IEC-Bus.....	3.1
3.2.2	RS-232 Interface.....	3.2
<b>3.3</b>	<b>Switchover to Remote Control.....</b>	<b>3.2</b>
3.3.1	Remote Control via IEC Bus.....	3.3
3.3.1.1	Setting the Device Address .....	3.3
3.3.1.2	Indications during Remote Control .....	3.3
3.3.1.3	Querying the Error Status.....	3.3
3.3.1.4	Return to Manual Operation .....	3.3
3.3.2	Remote Control via RS-232-Interface.....	3.4
3.3.2.1	Setting the Transmission Parameters .....	3.4
3.3.2.2	Indications during Remote Control .....	3.4
3.3.2.3	Return to Manual Operating .....	3.4
<b>3.4</b>	<b>Messages .....</b>	<b>3.4</b>
3.4.1	Interface Message .....	3.4
3.4.2	Device Messages (Commands and Device Responses) .....	3.5
<b>3.5</b>	<b>Structure and Syntax of the Device Messages.....</b>	<b>3.5</b>
3.5.1	SCPI Introduction.....	3.5
3.5.2	Structure of a Command .....	3.6
3.5.3	Structure of a Command Line.....	3.8
3.5.4	Responses to Queries .....	3.8
3.5.5	Parameter .....	3.9
3.5.6	Overview of Syntax Elements .....	3.11
<b>3.6</b>	<b>Description of Commands.....</b>	<b>3.12</b>
3.6.1	Notation.....	3.12
3.6.2	Common Commands.....	3.14
3.6.3	ABORt System.....	3.17
3.6.4	CALibration-System .....	3.18
3.6.5	DIAGnostic-System .....	3.21
3.6.6	DISPLAY-System.....	3.24
3.6.7	FORMat-System .....	3.25
3.6.8	MEMory System.....	3.26
3.6.9	OUTPut-System.....	3.26
3.6.10	OUTPut2 System .....	3.28
3.6.11	SOURce-System .....	3.29
3.6.11.1	SOURce:AM Subsystem .....	3.30
3.6.11.2	SOURce:CORRection Subsystem .....	3.32
3.6.11.3	SOURce:DM Subsystem .....	3.34
3.6.11.4	SOURce:ERMes Subsystem.....	3.50
3.6.11.5	SOURce:FLEX Subsystem .....	3.55
3.6.11.6	SOURce:FM Subsystem .....	3.63



3.6.11.7	SOURce:FREQUency Subsystem .....	3.65
3.6.11.8	SOURce:ILS Subsystem .....	3.68
3.6.11.9	SOURce:LIST Subsystem .....	3.75
3.6.11.10	SOURce:MARKer Subsystem .....	3.78
3.6.11.11	SOURce:MBEacon Subsystem .....	3.80
3.6.11.12	SOURce:PHASe Subsystem .....	3.81
3.6.11.13	SOURce:PM Subsystem .....	3.82
3.6.11.14	SOURce:POCSag Subsystem .....	3.84
3.6.11.15	SOURce:POWer Subsystem .....	3.88
3.6.11.16	SOURce:PULM Subsystem .....	3.91
3.6.11.17	SOURce:PULSe Subsystem .....	3.92
3.6.11.18	SOURce:REFLeX25 Subsystem .....	3.93
3.6.11.19	SOURce:ROSCillator Subsystem .....	3.99
3.6.11.20	SOURce:STEReo Subsystem .....	3.100
3.6.11.21	SOURce:SWEEp Subsystem .....	3.103
3.6.11.22	SOURce:VOR Subsystem .....	3.106
3.6.12	SOURce0 2 System .....	3.109
3.6.12.1	SOURce0 2:FREQUency Subsystem .....	3.109
3.6.12.2	SOURce 0 2:FUNCTion-Subsystem .....	3.111
3.6.12.3	SOURce2:MARKer-Subsystem .....	3.112
3.6.12.4	SOURce2:SWEEp-Subsystem .....	3.113
3.6.13	STATus-System .....	3.115
3.6.14	SYSTem-System .....	3.117
3.6.15	TEST-System .....	3.122
3.6.16	TRIGger-System .....	3.124
3.6.17	UNIT-System .....	3.129
<b>3.7</b>	<b>Instrument Model and Command Processing .....</b>	<b>3.130</b>
3.7.1	Input Unit .....	3.130
3.7.2	Command Recognition .....	3.131
3.7.3	Data Set and Instrument Hardware .....	3.131
3.7.4	Status Reporting System .....	3.131
3.7.5	Output Unit .....	3.132
3.7.6	Command Sequence and Command Synchronization .....	3.132
<b>3.8</b>	<b>Status Reporting System .....</b>	<b>3.133</b>
3.8.1	Structure of an SCPI Status Register .....	3.133
3.8.2	Overview of the Status Registers .....	3.135
3.8.3	Description of the Status Registers .....	3.136
3.8.3.1	Status Byte (STB) and Service Request Enable Register (SRE) .....	3.136
3.8.3.2	IST Flag and Parallel Poll Enable Register (PPE) .....	3.137
3.8.3.3	Event Status Register (ESR) and Event Status Enable Register (ESE) ..	3.137
3.8.3.4	STATus:OPERation Register .....	3.138
3.8.3.5	STATus:QUEStionable Register .....	3.139
3.8.4	Application of the Status Reporting Systems .....	3.140
3.8.4.1	Service Request, Making Use of the Hierarchy Structure .....	3.140
3.8.4.2	Serial Poll .....	3.140
3.8.4.3	Parallel Poll .....	3.141
3.8.4.4	Query by Means of Commands .....	3.141
3.8.4.5	Error Queue Query .....	3.141
3.8.5	Resetting Values of the Status Reporting Systems .....	3.142
<b>3.9</b>	<b>Fast Restore Mode .....</b>	<b>3.143</b>

<b>4</b>	<b>Maintenance and Troubleshooting</b> .....	<b>4.1</b>
<b>4.1</b>	<b>Maintenance</b> .....	<b>4.1</b>
4.1.1	Cleaning the Outside .....	4.1
4.1.2	Storage .....	4.1
4.1.3	Exchange of the Lithium Batteries .....	4.1
4.1.3.1	Exchange of RAM Battery .....	4.2
4.1.3.2	Exchange of XMEM Battery .....	4.4
<b>4.2</b>	<b>Functional Test</b> .....	<b>4.5</b>
<b>5</b>	<b>Performance Test</b> .....	<b>5.1</b>
<b>5.1</b>	<b>Test Instruments and Utilities</b> .....	<b>5.1</b>
5.1.1	Test Systems to Measure Modulation Characteristics.....	5.3
5.1.1.1	Standard Test System .....	5.3
5.1.1.2	Test System with Audio Analyzer .....	5.3
5.1.1.3	Test System for Broadband FM .....	5.4
5.1.1.4	Test System for Pulse Modulation.....	5.4
5.1.1.5	Test System for GFSK .....	5.5
5.1.1.6	Test System Extension by Down Conversion.....	5.5
<b>5.2</b>	<b>Test Procedure</b> .....	<b>5.6</b>
5.2.1	Display and Keyboard .....	5.6
5.2.2	Frequency Setting.....	5.6
5.2.3	Settling Time.....	5.8
5.2.4	Reference Frequency .....	5.10
5.2.5	Harmonics Suppression/Subharmonics .....	5.10
5.2.6	Suppression of Nonharmonics.....	5.11
5.2.7	SSB Phase Noise .....	5.12
5.2.8	Broadband Noise .....	5.14
5.2.9	Residual FM.....	5.14
5.2.10	Residual AM.....	5.15
5.2.11	Output Level.....	5.15
5.2.12	Output Reflection Coefficient.....	5.17
5.2.13	Interrupt-free Level Setting (ATTEN FIXED) .....	5.18
5.2.14	Overvoltage Protection (SME02 and SME03 only).....	5.19
5.2.15	Level Monitoring at Input EXT1.....	5.19
5.2.16	Modulation Depth of AM .....	5.20
5.2.17	AM Frequency Response .....	5.20
5.2.18	AM Distortion Factor .....	5.21
5.2.19	Residual PhiM with AM .....	5.21
5.2.20	Level Monitoring at Input EXT2 (Option SM-B5) .....	5.22
5.2.21	FM Deviation Setting.....	5.22
5.2.22	FM Frequency Response.....	5.23
5.2.22.1	FM Frequency Response up to 100 kHz.....	5.23
5.2.22.2	FM Frequency Response up to 2 MHz.....	5.23
5.2.23	FM Distortion Factor .....	5.24
5.2.24	FM Preemphasis.....	5.24
5.2.25	Residual AM with FM .....	5.24
5.2.26	Carrier frequency Deviation with FM.....	5.25

5.2.27	FM Stereo Modulation.....	5.25
5.2.28	PhiM Deviation Setting.....	5.26
5.2.29	PhiM Frequency Response.....	5.26
5.2.30	PhiM Distortion Factor .....	5.27
5.2.31	Internal Modulation Generator .....	5.27
5.2.32	Pulse Modulation (Option SM-B3/B8/B9).....	5.28
5.2.32.1	ON/OFF - Ratio .....	5.28
5.2.32.2	Dynamic Characteristics.....	5.28
5.2.33	GFSK Modulation (Option SME-B11) .....	5.29
5.2.33.1	Spectrum .....	5.29
5.2.33.2	Deviation Error.....	5.31
5.2.34	QPSK Modulation .....	5.32
5.2.34.1	Spectrum .....	5.32
5.2.34.2	Vector Error (NADC Standard IS-54) .....	5.33
5.2.35	GMSK Modulation.....	5.34
5.2.35.1	Spectrum .....	5.34
5.2.35.2	Phase Error .....	5.35
5.2.36	FFSK Modulation .....	5.37
5.2.37	LF Generator (Option SM-B2) .....	5.37
5.2.37.1	Frequency Error.....	5.37
5.2.37.2	Frequency Response .....	5.38
5.2.38	Pulse Generator (Option SM-B4).....	5.38
5.2.39	Multi-Function Generator (Option SM-B6) .....	5.40
5.2.39.1	Frequency Error, Distortion Factor and Level.....	5.40
5.2.39.2	Frequency Response .....	5.40
5.2.39.3	Distortion Factor and Crosstalk Attenuation Stereo .....	5.41
5.2.39.4	Pilot Tone Level.....	5.41
5.2.40	Memory Extension (Option SME-B12).....	5.42
5.2.40.1	Read/Write Check via the IEC/IEEE Bus .....	5.42
5.2.40.2	Dibit Synchronization .....	5.43
5.2.40.3	External Triggering .....	5.43
<b>5.3</b>	<b>Performance Test .....</b>	<b>5.44</b>
<b>Annex A</b>	<b>.....</b>	<b>7B.1</b>
	<b>IEC/IEEE Bus Interface .....</b>	<b>7B.1</b>
	Characteristics of the Interface.....	7B.1
	Bus Lines .....	7B.1
	Interface Messages .....	7B.3
	<b>RS-232-C Interface .....</b>	<b>7B.4</b>
	Interface characteristics.....	7B.4
	Signal lines .....	7B.4
	Transmission parameters .....	7B.5
	Interface functions .....	7B.5
	Handshake.....	7B.6

<b>Annex B .....</b>	<b>8C.1</b>
List of Error Messages.....	8C.1
SCPI-Specific Error Messages .....	8C.1
SME-Specific Error Messages.....	8C.5
 <b>Annex D .....</b>	 <b>9D.1</b>
1. Including IEC-Bus Library for QuickBasic.....	9D.1
2. Initialization and Default Status.....	9D.1
2.1. Initiate Controller.....	9D.1
2.2. Initiate Instrument .....	9D.1
3. Transmission of Instrument Setting Commands .....	9D.2
4. Switchover to Manual Control.....	9D.2
5. Reading out Instrument Settings .....	9D.2
6. List Management .....	9D.3
7. Command synchronization .....	9D.3
8. Service Request.....	9D.4

## Tables

Table 2-1	Input sockets for the different types of modulation .....	2.50
Table 2-2	Status messages in the case of a deviation .....	2.51
Table 2-3	Modulations which cannot be operated simultaneously.....	2.52
Table 2-4	Modulation generators as component parts .....	2.53
Table 2-5	Radio network data .....	2.86
Table 2-6	LIST mode; Example of a list.....	2.143
Table 2-7	MEMORY SEQUENCE; Example of a list .....	2.148
Table 3-1	Common Commands.....	3.14
Table 3-2	Device Response to *OPT?.....	3.15
Table 3-3	Synchronization with *OPC?, *OPC? And *WAI .....	3.132
Table 3-4	Overview of the status register .....	3.136
Table 3-5	Meaning of the bits used in the event status register .....	3.137
Table 3-6	Meaning of the bits used in the STATus:OPERation register.....	3.138
Table 3-7	Meaning of the bits used in the STATus:QUESTionable register .....	3.139
Table 3-8	Resetting instrument functions .....	3.142
Table 5-1	Test Instruments and Utilities .....	5.1
Table 5-2a,b	Changeover limits of the SME .....	5.6
Table 5-3	Test report .....	5.44

## Figures

Fig. 1-1	SME, View from the top .....	1.5
Fig. 2-1, a to c	Front panel view, display.....	2.2, 2.4, 2.6, 2.8, 2.10
Fig. 2-1	Rear panel view .....	2.12
Fig. 2-3	Design of the display.....	2.18
Fig. 2-4	MODULATION-AM menu .....	2.19
Fig. 2-5	Display after AM setting.....	2.25
Fig. 2-6	Display after pattern setting .....	2.27
Fig. 2-7	OPERATION page of the MEM SEQ menu .....	2.28
Fig. 2-8	SELECT-LIST-selection window.....	2.29
Fig. 2-9	DELETE-LIST selection window.....	2.30
Fig. 2-10	Edit function EDIT/VIEW .....	2.31
Fig. 2-11	Block function FILL: Input window .....	2.32
Fig. 2-12	Edit function INSERT: Input window .....	2.34
Fig. 2-13	Edit function DELETE: Input window .....	2.35
Fig. 2-14	Starting point of the pattern setting .....	2.36
Fig. 2-15, a to c	Pattern setting - Edition of a list .....	2.38
Fig. 2-16	Menu FREQUENCY (preset setting) .....	2.41
Fig. 2-17	Example of a circuit with frequency offset .....	2.42
Fig. 2-18	Menu LEVEL (preset setting) POWER RESOLUTION is set to 0.01 dB.....	2.43
Fig. 2-19	Example of a circuit with level offset.....	2.45
Fig. 2-20	Menu LEVEL - ALC (preset setting) .....	2.46
Fig. 2-21	Menu LEVEL - UCOR - OPERATION side.....	2.47
Fig. 2-22	Menu UCOR - LEVEL-EDIT side .....	2.48
Fig. 2-23	Menu LEVEL-EMF .....	2.49
Fig. 2-24	Menu MODULATION-AM (preset setting) .....	2.54
Fig. 2-25	Menu MODULATION-FM (preset setting) .....	2.56
Fig. 2-26	Dependency of the FM maximal deviation on the RF frequency set .....	2.57
Fig. 2-27	Menu MODULATION - PM (preset setting) .....	2.58
Fig. 2-28	Dependency of the PM maximal deviation on the RF frequency set .....	2.59
Fig. 2-29	Signal example 1: single pulse, TRIGGER MODE = AUTO.....	2.60
Fig. 2-30	Signal example 2: double pulse, TRIGGER MODE = EXT, SLOPE = POS.....	2.61
Fig. 2-31	Menu MODULATION-PULSE (preset setting).....	2.61
Fig. 2-32	Menu MODULATION-STEREO (preset setting).....	2.63
Fig. 2-33	Menu MODULATION-VOR (preset setting).....	2.65
Fig. 2-34	Menu MODULATION-ILS-GS (preset setting).....	2.68

Fig. 2-35	Menu MODULATION-ILS-LOC (preset setting) .....	2.72
Fig. 2-36	Menu MODULATION-MKR-BCN (preset settings) .....	2.76
Fig. 2-37	Menu DIGITAL MOD-GMSK, edit page .....	2.79
Fig. 2-38	Signal example with respect to DM delay and delays of level control .....	2.80
Fig. 2-39	Selection of the memory extension in submenu SELECT LIST .....	2.81
Fig. 2-40	Submenu DIGITAL MOD-GMSK-CONFIG XMEM .....	2.82
Fig. 2-41	Menu DIGITAL-MOD-GMSK (preset setting) .....	2.87
Fig. 2-42	Menu DIGITAL MOD-GFSK (preset setting) .....	2.89
Fig. 2-43	Menu DIGITAL MOD - QPSK (preset setting) .....	2.91
Fig. 2-44	Submenu DIGITAL-MOD-QPSK-CLOCK...(preset setting) .....	2.92
Fig. 2-45	Menu DIGITAL MOD - FSK (preset setting) .....	2.94
Fig. 2-46	Menu DIGITAL MOD - 4FSK (preset setting) .....	2.97
Fig. 2-47	Menu DIGITAL MOD - FFSK (preset setting) .....	2.100
Fig. 2-48	Menu DIGITAL MOD - ERMES (preset setting) .....	2.102
Fig. 2-49	Menu DIGITAL MOD - FLEX, options SME-B41, SME-B11, SM-B12 .....	2.107
Fig. 2-50	Menu DIGITAL MOD - ReFLEX .....	2.119
Fig. 2-51	Menu DIGITAL MOD-POCSAG .....	2.127
Fig. 2-52	Menu LF OUTPUT (preset setting) .....	2.132
Fig. 2-53	Signal example sweep: MODE = AUTO, BLANK TIME = NORMAL .....	2.137
Fig. 2-54	Signal example sweep: MODE = SINGLE, BLANK TIME = LONG .....	2.137
Fig. 2-55	Menu SWEEP - FREQ .....	2.138
Fig. 2-56	Menu SWEEP - LEVEL .....	2.140
Fig. 2-57	Menu SWEEP - LF GEN .....	2.141
Fig. 2-58	Signal example LIST mode: MODE = EXT-STEP .....	2.145
Fig. 2-59	Menu LIST - OPERATION page .....	2.145
Fig. 2-60	Menu List - EDIT page .....	2.147
Fig. 2-61	Menu MEM SEQ -OPERATION-page (preset setting) .....	2.150
Fig. 2-62	Menu MEM SEQ - EDIT page .....	2.151
Fig. 2-63	Menu UTILITIES -SYSTEM -GPIB .....	2.152
Fig. 2-64	Menu UTILITIES - SYSTEM - RS232 .....	2.153
Fig. 2-65	Menu UTILITIES - SYSTEM-SECURITY .....	2.154
Fig. 2-66	Menu UTILITIES - REF OSC (preset setting) .....	2.155
Fig. 2-67	Menu UTILITIES - PHASE (preset setting) .....	2.156
Fig. 2-68	Menu UTILITIES - PROTECT (preset setting) .....	2.157
Fig. 2-69	Menu UTILITIES - CALIB - VCO SUM .....	2.158
Fig. 2-70	Menu UTILITIES - CALIB - LEV PRESET .....	2.159
Fig. 2-71	Menu UTILITIES - CALIB - PULSE GEN .....	2.160
Fig. 2-72	Menu UTILITIES - CALIB - QPSK .....	2.161
Fig. 2-73	Menu UTILITIES - DIAG - CONFIG .....	2.162
Fig. 2-74	Menu UTILITIES - DIAG - TPOINT .....	2.163
Fig. 2-75	Menu UTILITIES - DIAG - PARAM .....	2.164
Fig. 2-76	Menu UTILITIES - MOD KEY (preset setting) .....	2.165
Fig. 2-77	Menu UTILITIES - AUX I/O .....	2.166
Fig. 2-78	Menu UTILITIES - BEEPER .....	2.167
Fig. 2-79	Menu UTILITIES - INSTALL, fitted with options .....	2.168
Fig. 2-80	Menu STATUS page .....	2.169
Fig. 2-81	ERROR page .....	2.170
Fig. 3-1	Tree structure of the SCPI command systems .....	3.6
Fig. 3-2	Instrument model in the case of remote control by means of the IEC bus .....	3.130
Fig. 3-3	The status -register model .....	3.133
Fig. 3-4	Overview of the status register .....	3.135
Fig. 4-1	Shielding cover of controller and front panel module .....	4.3
Fig. 4-2	Position of the RAM battery on the PCB .....	4.3
Fig. 4-3	Position of the XMEM battery .....	4.5
Fig. 4-4	UTILITIES-TEST menu .....	4.5
Fig. 5-1	Spectrum with GFSK .....	5.29
Fig. 5-2	Spectrum with QPSK .....	5.33
Fig. 5-3	Spectrum with GMSK .....	5.34



**Before putting the product into operation for the first time, make sure to read the following**



# Safety Instructions

Rohde & Schwarz makes every effort to keep the safety standard of its products up to date and to offer its customers the highest possible degree of safety. Our products and the auxiliary equipment required for them are designed and tested in accordance with the relevant safety standards. Compliance with these standards is continuously monitored by our quality assurance system. This product has been designed and tested in accordance with the EC Certificate of Conformity and has left the manufacturer's plant in a condition fully complying with safety standards. To maintain this condition and to ensure safe operation, observe all instructions and warnings provided in this manual. If you have any questions regarding these safety instructions, Rohde & Schwarz will be happy to answer them.

Furthermore, it is your responsibility to use the product in an appropriate manner. This product is designed for use solely in industrial and laboratory environments or in the field and must not be used in any way that may cause personal injury or property damage. You are responsible if the product is used for an intention other than its designated purpose or in disregard of the manufacturer's instructions. The manufacturer shall assume no responsibility for such use of the product.

The product is used for its designated purpose if it is used in accordance with its operating manual and within its performance limits (see data sheet, documentation, the following safety instructions). Using the products requires technical skills and knowledge of English. It is therefore essential that the products be used exclusively by skilled and specialized staff or thoroughly trained personnel with the required skills. If personal safety gear is required for using Rohde & Schwarz products, this will be indicated at the appropriate place in the product documentation.

## Symbols and safety labels

Observe operating instructions	Weight indication for units >18 kg	Danger of electric shock	Warning! Hot surface	PE terminal	Ground	Ground terminal	Attention! Electrostatic sensitive devices

Supply voltage ON/OFF	Standby indication	Direct current (DC)	Alternating current (AC)	Direct/alternating current (DC/AC)	Device fully protected by double/reinforced insulation

## Safety Instructions

Observing the safety instructions will help prevent personal injury or damage of any kind caused by dangerous situations. Therefore, carefully read through and adhere to the following safety instructions before putting the product into operation. It is also absolutely essential to observe the additional safety instructions on personal safety that appear in other parts of the documentation. In these safety instructions, the word "product" refers to all merchandise sold and distributed by Rohde & Schwarz, including instruments, systems and all accessories.

### Tags and their meaning

DANGER	This tag indicates a safety hazard with a high potential of risk for the user that can result in death or serious injuries.
WARNING	This tag indicates a safety hazard with a medium potential of risk for the user that can result in death or serious injuries.
CAUTION	This tag indicates a safety hazard with a low potential of risk for the user that can result in slight or minor injuries.
ATTENTION	This tag indicates the possibility of incorrect use that can cause damage to the product.
NOTE	This tag indicates a situation where the user should pay special attention to operating the product but which does not lead to damage.

These tags are in accordance with the standard definition for civil applications in the European Economic Area. Definitions that deviate from the standard definition may also exist. It is therefore essential to make sure that the tags described here are always used only in connection with the associated documentation and the associated product. The use of tags in connection with unassociated products or unassociated documentation can result in misinterpretations and thus contribute to personal injury or material damage.

### Basic safety instructions

1. The product may be operated only under the operating conditions and in the positions specified by the manufacturer. Its ventilation must not be obstructed during operation. Unless otherwise specified, the following requirements apply to Rohde & Schwarz products:  
prescribed operating position is always with the housing floor facing down, IP protection 2X, pollution severity 2, overvoltage category 2, use only in enclosed spaces, max. operation altitude max. 2000 m. Unless specified otherwise in the data sheet, a tolerance of  $\pm 10\%$  shall apply to the nominal voltage and of  $\pm 5\%$  to the nominal frequency.
2. Applicable local or national safety regulations and rules for the prevention of accidents must be observed in all work performed. The product may be opened only by authorized, specially trained personnel. Prior to performing any work on the product or opening the product, the product must be disconnected from the supply network. Any adjustments, replacements of parts, maintenance or repair must be carried out only by technical personnel authorized by Rohde & Schwarz. Only original parts may be used for replacing parts relevant to safety (e.g. power switches, power transformers, fuses). A safety test must always be performed after parts relevant to safety have been replaced (visual inspection, PE conductor test, insulation resistance measurement, leakage current measurement, functional test).
3. As with all industrially manufactured goods, the use of substances that induce an allergic reaction (allergens, e.g. nickel) such as aluminum cannot be generally excluded. If you develop an allergic reaction (such as a skin rash, frequent sneezing, red eyes or respiratory difficulties), consult a physician immediately to determine the cause.



## Safety Instructions

4. If products/components are mechanically and/or thermally processed in a manner that goes beyond their intended use, hazardous substances (heavy-metal dust such as lead, beryllium, nickel) may be released. For this reason, the product may only be disassembled, e.g. for disposal purposes, by specially trained personnel. Improper disassembly may be hazardous to your health. National waste disposal regulations must be observed.
5. If handling the product yields hazardous substances or fuels that must be disposed of in a special way, e.g. coolants or engine oils that must be replenished regularly, the safety instructions of the manufacturer of the hazardous substances or fuels and the applicable regional waste disposal regulations must be observed. Also observe the relevant safety instructions in the product documentation.
6. Depending on the function, certain products such as RF radio equipment can produce an elevated level of electromagnetic radiation. Considering that unborn life requires increased protection, pregnant women should be protected by appropriate measures. Persons with pacemakers may also be endangered by electromagnetic radiation. The employer is required to assess workplaces where there is a special risk of exposure to radiation and, if necessary, take measures to avert the danger.
7. Operating the products requires special training and intense concentration. Make certain that persons who use the products are physically, mentally and emotionally fit enough to handle operating the products; otherwise injuries or material damage may occur. It is the responsibility of the employer to select suitable personnel for operating the products.
8. Prior to switching on the product, it must be ensured that the nominal voltage setting on the product matches the nominal voltage of the AC supply network. If a different voltage is to be set, the power fuse of the product may have to be changed accordingly.
9. In the case of products of safety class I with movable power cord and connector, operation is permitted only on sockets with earthing contact and protective earth connection.
10. Intentionally breaking the protective earth connection either in the feed line or in the product itself is not permitted. Doing so can result in the danger of an electric shock from the product. If extension cords or connector strips are implemented, they must be checked on a regular basis to ensure that they are safe to use.
11. If the product has no power switch for disconnection from the AC supply, the plug of the connecting cable is regarded as the disconnecting device. In such cases, it must be ensured that the power plug is easily reachable and accessible at all times (length of connecting cable approx. 2 m). Functional or electronic switches are not suitable for providing disconnection from the AC supply. If products without power switches are integrated in racks or systems, a disconnecting device must be provided at the system level.
12. Never use the product if the power cable is damaged. By taking appropriate safety measures and carefully laying the power cable, ensure that the cable cannot be damaged and that no one can be hurt by e.g. tripping over the cable or suffering an electric shock.
13. The product may be operated only from TN/TT supply networks fused with max. 16 A.
14. Do not insert the plug into sockets that are dusty or dirty. Insert the plug firmly and all the way into the socket. Otherwise this can result in sparks, fire and/or injuries.
15. Do not overload any sockets, extension cords or connector strips; doing so can cause fire or electric shocks.
16. For measurements in circuits with voltages  $V_{rms} > 30 V$ , suitable measures (e.g. appropriate measuring equipment, fusing, current limiting, electrical separation, insulation) should be taken to avoid any hazards.
17. Ensure that the connections with information technology equipment comply with IEC 950/EN 60950.
18. Never remove the cover or part of the housing while you are operating the product. This will expose circuits and components and can lead to injuries, fire or damage to the product.

## Safety Instructions

19. If a product is to be permanently installed, the connection between the PE terminal on site and the product's PE conductor must be made first before any other connection is made. The product may be installed and connected only by a skilled electrician.
20. For permanently installed equipment without built-in fuses, circuit breakers or similar protective devices, the supply circuit must be fused in such a way that suitable protection is provided for users and products.
21. Do not insert any objects into the openings in the housing that are not designed for this purpose. Never pour any liquids onto or into the housing. This can cause short circuits inside the product and/or electric shocks, fire or injuries.
22. Use suitable overvoltage protection to ensure that no overvoltage (such as that caused by a thunderstorm) can reach the product. Otherwise the operating personnel will be endangered by electric shocks.
23. Rohde & Schwarz products are not protected against penetration of water, unless otherwise specified (see also safety instruction 1.). If this is not taken into account, there exists the danger of electric shock or damage to the product, which can also lead to personal injury.
24. Never use the product under conditions in which condensation has formed or can form in or on the product, e.g. if the product was moved from a cold to a warm environment.
25. Do not close any slots or openings on the product, since they are necessary for ventilation and prevent the product from overheating. Do not place the product on soft surfaces such as sofas or rugs or inside a closed housing, unless this is well ventilated.
26. Do not place the product on heat-generating devices such as radiators or fan heaters. The temperature of the environment must not exceed the maximum temperature specified in the data sheet.
27. Batteries and storage batteries must not be exposed to high temperatures or fire. Keep batteries and storage batteries away from children. If batteries or storage batteries are improperly replaced, this can cause an explosion (warning: lithium cells). Replace the battery or storage battery only with the matching Rohde & Schwarz type (see spare parts list). Batteries and storage batteries are hazardous waste. Dispose of them only in specially marked containers. Observe local regulations regarding waste disposal. Do not short-circuit batteries or storage batteries.
28. Please be aware that in the event of a fire, toxic substances (gases, liquids etc.) that may be hazardous to your health may escape from the product.
29. Please be aware of the weight of the product. Be careful when moving it; otherwise you may injure your back or other parts of your body.
30. Do not place the product on surfaces, vehicles, cabinets or tables that for reasons of weight or stability are unsuitable for this purpose. Always follow the manufacturer's installation instructions when installing the product and fastening it to objects or structures (e.g. walls and shelves).
31. Handles on the products are designed exclusively for personnel to hold or carry the product. It is therefore not permissible to use handles for fastening the product to or on means of transport such as cranes, fork lifts, wagons, etc. The user is responsible for securely fastening the products to or on the means of transport and for observing the safety regulations of the manufacturer of the means of transport. Noncompliance can result in personal injury or material damage.
32. If you use the product in a vehicle, it is the sole responsibility of the driver to drive the vehicle safely. Adequately secure the product in the vehicle to prevent injuries or other damage in the event of an accident. Never use the product in a moving vehicle if doing so could distract the driver of the vehicle. The driver is always responsible for the safety of the vehicle; the manufacturer assumes no responsibility for accidents or collisions.
33. If a laser product (e.g. a CD/DVD drive) is integrated in a Rohde & Schwarz product, do not use any other settings or functions than those described in the documentation. Otherwise this may be hazardous to your health, since the laser beam can cause irreversible damage to your eyes. Never try to take such products apart, and never look into the laser beam.



**Por favor lea imprescindiblemente antes de la primera puesta en funcionamiento las siguientes informaciones de seguridad**



## Informaciones de seguridad

Es el principio de Rohde & Schwarz de tener a sus productos siempre al día con los estándares de seguridad y de ofrecer a sus clientes el máximo grado de seguridad. Nuestros productos y todos los equipos adicionales son siempre fabricados y examinados según las normas de seguridad vigentes. Nuestra sección de gestión de la seguridad de calidad controla constantemente que sean cumplidas estas normas. Este producto ha sido fabricado y examinado según el comprobante de conformidad adjunto según las normas de la CE y ha salido de nuestra planta en estado impecable según los estándares técnicos de seguridad. Para poder preservar este estado y garantizar un funcionamiento libre de peligros, deberá el usuario atenerse a todas las informaciones, informaciones de seguridad y notas de alerta. Rohde&Schwarz está siempre a su disposición en caso de que tengan preguntas referentes a estas informaciones de seguridad.

Además queda en la responsabilidad del usuario utilizar el producto en la forma debida. Este producto solamente fue elaborado para ser utilizado en la industria y el laboratorio o para fines de campo y de ninguna manera deberá ser utilizado de modo que alguna persona/cosa pueda ser dañada. El uso del producto fuera de sus fines definidos o despreciando las informaciones de seguridad del fabricante queda en la responsabilidad del usuario. El fabricante no se hace en ninguna forma responsable de consecuencias a causa del maluso del producto.

Se parte del uso correcto del producto para los fines definidos si el producto es utilizado dentro de las instrucciones del correspondiente manual del uso y dentro del margen de rendimiento definido (ver hoja de datos, documentación, informaciones de seguridad que siguen). El uso de los productos hace necesarios conocimientos profundos y el conocimiento del idioma inglés. Por eso se deberá tener en cuenta de exclusivamente autorizar para el uso de los productos a personas peritas o debidamente minuciosamente instruidas con los conocimientos citados. Si fuera necesaria indumentaria de seguridad para el uso de productos de R&S, encontrará la información debida en la documentación del producto en el capítulo correspondiente.

### Símbolos y definiciones de seguridad

Ver manual de instrucciones del uso	Informaciones para maquinaria con un peso de > 18kg	Peligro de golpe de corriente	¡Advertencia! Superficie caliente	Conexión a conductor protector	Conexión a tierra	Conexión a masa conductora	¡Cuidado! Elementos de construcción con peligro de carga electrostática

potencia EN MARCHA/PARADA	Indicación Stand-by	Corriente continua DC	Corriente alterna AC	Corriente continua/alterna DC/AC	El aparato está protegido en su totalidad por un aislamiento de doble refuerzo

## Informaciones de seguridad

Tener en cuenta las informaciones de seguridad sirve para tratar de evitar daños y peligros de toda clase. Es necesario de que se lean las siguientes informaciones de seguridad concienzudamente y se tengan en cuenta debidamente antes de la puesta en funcionamiento del producto. También deberán ser tenidas en cuenta las informaciones para la protección de personas que encontrarán en otro capítulo de esta documentación y que también son obligatorias de seguir. En las informaciones de seguridad actuales hemos juntado todos los objetos vendidos por Rohde&Schwarz bajo la denominación de „producto“, entre ellos también aparatos, instalaciones así como toda clase de accesorios.

### Palabras de señal y su significado

PELIGRO	Indica un punto de peligro con gran potencial de riesgo para el usuario. Punto de peligro que puede llevar hasta la muerte o graves heridas.
ADVERTENCIA	Indica un punto de peligro con un potencial de riesgo mediano para el usuario. Punto de peligro que puede llevar hasta la muerte o graves heridas .
ATENCIÓN	Indica un punto de peligro con un potencial de riesgo pequeño para el usuario. Punto de peligro que puede llevar hasta heridas leves o pequeñas
CUIDADO	Indica la posibilidad de utilizar mal el producto y a consecuencia dañarlo.
INFORMACIÓN	Indica una situación en la que deberían seguirse las instrucciones en el uso del producto, pero que no consecuentemente deben de llevar a un daño del mismo.

Las palabras de señal corresponden a la definición habitual para aplicaciones civiles en el ámbito de la comunidad económica europea. Pueden existir definiciones diferentes a esta definición. Por eso se debiera tener en cuenta que las palabras de señal aquí descritas sean utilizadas siempre solamente en combinación con la correspondiente documentación y solamente en combinación con el producto correspondiente. La utilización de las palabras de señal en combinación con productos o documentaciones que no les correspondan puede llevar a malinterpretaciones y tener por consecuencia daños en personas u objetos.

### Informaciones de seguridad elementales

1. El producto solamente debe ser utilizado según lo indicado por el fabricante referente a la situación y posición de funcionamiento sin que se obstruya la ventilación. Si no se convino de otra manera, es para los productos R&S válido lo que sigue: como posición de funcionamiento se define principalmente la posición con el suelo de la caja para abajo , modo de protección IP 2X, grado de suciedad 2, categoría de sobrecarga eléctrica 2, utilizar solamente en estancias interiores, utilización hasta 2000 m sobre el nivel del mar.  
A menos que se especifique otra cosa en la hoja de datos, se aplicará una tolerancia de  $\pm 10\%$  sobre el voltaje nominal y de  $\pm 5\%$  sobre la frecuencia nominal.
2. En todos los trabajos deberán ser tenidas en cuenta las normas locales de seguridad de trabajo y de prevención de accidentes. El producto solamente debe de ser abierto por personal périto autorizado. Antes de efectuar trabajos en el producto o abrirlo deberá este ser desconectado de la corriente. El ajuste, el cambio de partes, la manutención y la reparación deberán ser solamente efectuadas por electricistas autorizados por R&S. Si se reponen partes con importancia para los aspectos de seguridad (por ejemplo el enchufe, los transformadores o los fusibles), solamente podrán ser sustituidos por partes originales. Despues de cada recambio de partes elementales para la seguridad deberá ser efectuado un control de

## Informaciones de seguridad

- seguridad (control a primera vista, control de conductor protector, medición de resistencia de aislamiento, medición de medición de la corriente conductora, control de funcionamiento).
3. Como en todo producto de fabricación industrial no puede ser excluido en general de que se produzcan al usarlo elementos que puedan generar alergias, los llamados elementos alergénicos (por ejemplo el níquel). Si se produjeran en el trato con productos R&S reacciones alérgicas, como por ejemplo urticaria, estornudos frecuentes, irritación de la conjuntiva o dificultades al respirar, se deberá consultar inmediatamente a un médico para averiguar los motivos de estas reacciones.
  4. Si productos / elementos de construcción son tratados fuera del funcionamiento definido de forma mecánica o térmica, pueden generarse elementos peligrosos (polvos de sustancia de metales pesados como por ejemplo plomo, berilio, níquel). La partición elemental del producto, como por ejemplo sucede en el tratamiento de materias residuales, debe de ser efectuada solamente por personal especializado para estos tratamientos. La partición elemental efectuada inadecuadamente puede generar daños para la salud. Se deben tener en cuenta las directivas nacionales referentes al tratamiento de materias residuales.
  5. En el caso de que se produjeran agentes de peligro o combustibles en la aplicación del producto que debieran de ser transferidos a un tratamiento de materias residuales, como por ejemplo agentes refrigerantes que deben ser repuestos en periodos definidos, o aceites para motores, deberán ser tenidas en cuenta las prescripciones de seguridad del fabricante de estos agentes de peligro o combustibles y las regulaciones regionales para el tratamiento de materias residuales. Cuiden también de tener en cuenta en caso dado las prescripciones de seguridad especiales en la descripción del producto.
  6. Ciertos productos, como por ejemplo las instalaciones de radiación HF, pueden a causa de su función natural, emitir una radiación electromagnética aumentada. En vista a la protección de la vida en desarrollo deberían ser protegidas personas embarazadas debidamente. También las personas con un bypass pueden correr peligro a causa de la radiación electromagnética. El empresario está comprometido a valorar y señalar áreas de trabajo en las que se corra un riesgo de exposición a radiaciones aumentadas de riesgo aumentado para evitar riesgos.
  7. La utilización de los productos requiere instrucciones especiales y una alta concentración en el manejo. Debe de ponerse por seguro de que las personas que manejen los productos estén a la altura de los requerimientos necesarios referente a sus aptitudes físicas, psíquicas y emocionales, ya que de otra manera no se pueden excluir lesiones o daños de objetos. El empresario lleva la responsabilidad de seleccionar el personal usuario apto para el manejo de los productos.
  8. Antes de la puesta en marcha del producto se deberá tener por seguro de que la tensión preseleccionada en el producto equivalga a la del la red de distribución. Si es necesario cambiar la preselección de la tensión también se deberán en caso dabo cambiar los fusibles correspondientes del producto.
  9. Productos de la clase de seguridad I con alimentación móvil y enchufe individual de producto solamente deberán ser conectados para el funcionamiento a tomas de corriente de contacto de seguridad y con conductor protector conectado.
  10. Queda prohibida toda clase de interrupción intencionada del conductor protector, tanto en la toma de corriente como en el mismo producto ya que puede tener como consecuencia el peligro de golpe de corriente por el producto. Si se utilizaran cables o enchufes de extensión se deberá poner al seguro, que es controlado su estado técnico de seguridad.
  11. Si el producto no está equipado con un interruptor para desconectarlo de la red, se deberá considerar el enchufe del cable de distribución como interruptor. En estos casos deberá asegurar de que el enchufe sea de fácil acceso y nabejo (medida del cable de distribución aproximadamente 2 m). Los interruptores de función o electrónicos no son aptos para el corte de la red eléctrica. Si los productos sin interruptor están integrados en construcciones o instalaciones, se deberá instalar el interruptor al nivel de la instalación.

## Informaciones de seguridad

12. No utilice nunca el producto si está dañado el cable eléctrico. Asegure a través de las medidas de protección y de instalación adecuadas de que el cable de eléctrico no pueda ser dañado o de que nadie pueda ser dañado por él, por ejemplo al tropezar o por un golpe de corriente.
13. Solamente está permitido el funcionamiento en redes de distribución TN/TT aseguradas con fusibles de como máximo 16 A.
14. Nunca conecte el enchufe en tomas de corriente sucias o llenas de polvo. Introduzca el enchufe por completo y fuertemente en la toma de corriente. Si no tiene en consideración estas indicaciones se arriesga a que se originen chispas, fuego y/o heridas.
15. No sobrecargue las tomas de corriente, los cables de extensión o los enchufes de extensión ya que esto pudiera causar fuego o golpes de corriente.
16. En las mediciones en circuitos de corriente con una tensión de entrada de  $U_{eff} > 30 \text{ V}$  se deberá tomar las precauciones debidas para impedir cualquier peligro (por ejemplo medios de medición adecuados, seguros, limitación de tensión, corte protector, aislamiento etc.).
17. En caso de conexión con aparatos de la técnica informática se deberá tener en cuenta que estos cumplan los requisitos de la EC950/EN60950.
18. Nunca abra la tapa o parte de ella si el producto está en funcionamiento. Esto pone a descubierto los cables y componentes eléctricos y puede causar heridas, fuego o daños en el producto.
19. Si un producto es instalado fijamente en un lugar, se deberá primero conectar el conductor protector fijo con el conductor protector del aparato antes de hacer cualquier otra conexión. La instalación y la conexión deberán ser efectuadas por un electricista especializado.
20. En caso de que los productos que son instalados fijamente en un lugar sean sin protector implementado, autointerruptor o similares objetos de protección, deberá la toma de corriente estar protegida de manera que los productos o los usuarios estén suficientemente protegidos.
21. Por favor, no introduzca ningún objeto que no esté destinado a ello en los orificios de la caja del aparato. No vierta nunca ninguna clase de líquidos sobre o en la caja. Esto puede producir corto circuitos en el producto y/o puede causar golpes de corriente, fuego o heridas.
22. Asegúrese con la protección adecuada de que no pueda originarse en el producto una sobrecarga por ejemplo a causa de una tormenta. Si no se verá el personal que lo utilice expuesto al peligro de un golpe de corriente.
23. Los productos R&S no están protegidos contra el agua si no es que exista otra indicación, ver también punto 1. Si no se tiene en cuenta esto se arriesga el peligro de golpe de corriente o de daños en el producto lo cual también puede llevar al peligro de personas.
24. No utilice el producto bajo condiciones en las que pueda producirse y se hayan producido líquidos de condensación en o dentro del producto como por ejemplo cuando se desplaza el producto de un lugar frío a un lugar caliente.
25. Por favor no cierre ninguna ranura u orificio del producto, ya que estas son necesarias para la ventilación e impiden que el producto se caliente demasiado. No pongan el producto encima de materiales blandos como por ejemplo sofás o alfombras o dentro de una caja cerrada, si esta no está suficientemente ventilada.
26. No ponga el producto sobre aparatos que produzcan calor, como por ejemplo radiadores o calentadores. La temperatura ambiental no debe superar la temperatura máxima especificada en la hoja de datos.

## Informaciones de seguridad

27. Baterías y acumuladores no deben de ser expuestos a temperaturas altas o al fuego. Guardar baterías y acumuladores fuera del alcance de los niños. Si las baterías o los acumuladores no son cambiados con la debida atención existirá peligro de explosión (atención celulas de Litio). Cambiar las baterías o los acumuladores solamente por los del tipo R&S correspondiente (ver lista de piezas de recambio). Baterías y acumuladores son deshechos problemáticos. Por favor tirenlos en los recipientes especiales para este fin. Por favor tengan en cuenta las prescripciones nacionales de cada país referente al tratamiento de deshechos. Nunca sometan las baterías o acumuladores a un corto circuito.
28. Tengan en consideración de que en caso de un incendio pueden escaparse gases tóxicos del producto, que pueden causar daños a la salud.
29. Por favor tengan en cuenta que en caso de un incendio pueden desprenderse del producto agentes venenosos (gases, líquidos etc.) que pueden generar daños a la salud.
30. No sitúe el producto encima de superficies, vehículos, estantes o mesas, que por sus características de peso o de estabilidad no sean aptas para él. Siga siempre las instrucciones de instalación del fabricante cuando instale y asegure el producto en objetos o estructuras (por ejemplo paredes y estantes).
31. Las asas instaladas en los productos sirven solamente de ayuda para el manejo que solamente está previsto para personas. Por eso no está permitido utilizar las asas para la sujecion en o sobre medios de transporte como por ejemplo grúas, carretillas elevadoras de horquilla, carros etc. El usuario es responsable de que los productos sean sujetados de forma segura a los medios de transporte y de que las prescripciones de seguridad del fabricante de los medios de transporte sean tenidas en cuenta. En caso de que no se tengan en cuenta pueden causarse daños en personas y objetos.
32. Si llega a utilizar el producto dentro de un vehículo, queda en la responsabilidad absoluta del conductor que conducir el vehículo de manera segura. Asegure el producto dentro del vehículo debidamente para evitar en caso de un accidente las lesiones u otra clase de daños. No utilice nunca el producto dentro de un vehículo en movimiento si esto pudiera distraer al conductor. Siempre queda en la responsabilidad absoluta del conductor la seguridad del vehículo y el fabricante no asumirá ninguna clase de responsabilidad por accidentes o colisiones.
33. Dado el caso de que esté integrado un producto de laser en un producto R&S (por ejemplo CD/DVD-ROM) no utilice otras instalaciones o funciones que las descritas en la documentación. De otra manera pondrá en peligro su salud, ya que el rayo laser puede dañar irreversiblemente sus ojos. Nunca trate de descomponer estos productos. Nunca mire dentro del rayo laser.





## Certified Quality System

**DIN EN ISO 9001 : 2000**  
**DIN EN 9100 : 2003**  
**DIN EN ISO 14001 : 1996**

**DQS REG. NO 001954 QM/ST UM**

### QUALITÄTSZERTIFIKAT

*Sehr geehrter Kunde,*

Sie haben sich für den Kauf eines Rohde & Schwarz-Produktes entschieden. Hiermit erhalten Sie ein nach modernsten Fertigungsmethoden hergestelltes Produkt. Es wurde nach den Regeln unseres Managementsystems entwickelt, gefertigt und geprüft.

Das Rohde & Schwarz Managementsystem ist zertifiziert nach:

DIN EN ISO 9001:2000  
DIN EN 9100:2003  
DIN EN ISO 14001:1996

### CERTIFICATE OF QUALITY

*Dear Customer,*

you have decided to buy a Rohde & Schwarz product. You are thus assured of receiving a product that is manufactured using the most modern methods available. This product was developed, manufactured and tested in compliance with our quality management system standards.

The Rohde & Schwarz quality management system is certified according to:

DIN EN ISO 9001:2000  
DIN EN 9100:2003  
DIN EN ISO 14001:1996

### CERTIFICAT DE QUALITÉ

*Cher Client,*

vous avez choisi d'acheter un produit Rohde & Schwarz. Vous disposez donc d'un produit fabriqué d'après les méthodes les plus avancées. Le développement, la fabrication et les tests respectent nos normes de gestion qualité.

Le système de gestion qualité de Rohde & Schwarz a été homologué conformément aux normes:

DIN EN ISO 9001:2000  
DIN EN 9100:2003  
DIN EN ISO 14001:1996



**ROHDE & SCHWARZ**





Certificate No.: 9502004

This is to certify that:

Equipment type	Order No.	Designation
SME02/03/06	1038.6002.02/.03/.06	Signal Generator
SME03A	1038.6002.53	"
SME03E	1038.6002.13	"
SME42	1038.6002.42	"
SME22/23/24	1038.6002.22/.23/.24	Power Signal Generator
SME-B11	1036.8720.02/.22	DM Coder
SME-B12	1039.4090.02	8MB Memory Extension

complies with the provisions of the Directive of the Council of the European Union on the approximation of the laws of the Member States

- relating to electrical equipment for use within defined voltage limits  
(73/23/EEC revised by 93/68/EEC)
- relating to electromagnetic compatibility  
(89/336/EEC revised by 91/263/EEC, 92/31/EEC, 93/68/EEC)

Conformity is proven by compliance with the following standards:

EN61010-1 : 1991  
EN50081-1 : 1992  
EN50082-1 : 1992

Affixing the EC conformity mark as from 1995

**ROHDE & SCHWARZ GmbH & Co. KG**  
Mühldorfstr. 15, D-81671 München

Munich, 1998-01-26

Central Quality Management FS-QZ / Becker





Certificate No.: 9502055

This is to certify that:

Equipment type	Order No.	Designation
SM-B1	1036.7599.02	Reference Oszillator
SM-B2	1036.7947.02/08	LF Generator
SM-B3	1036.6340.02	Pulse Modulator
SM-B4	1036.9310.02	Pulse Generator
SM-B5	1036.8489.02	FM/PHIM Modulator
SM-B6	1036.7760.02/08	Multifunction Generator
SM-B8	1036.6805.02	Pulse Modulator
SM-B9	1039.5100.02	Pulse Modulator
SM-B50	1104.8410.02	Fast CPU

complies with the provisions of the Directive of the Council of the European Union on the approximation of the laws of the Member States

- relating to electromagnetic compatibility  
(89/336/EEC revised by 91/263/EEC, 92/31/EEC, 93/68/EEC)

Conformity is proven by compliance with the following standards:

EN50081-1 : 1992  
EN50082-1 : 1992

Affixing the EC conformity mark as from 1995

**ROHDE & SCHWARZ GmbH & Co. KG**  
Mühldorfstr. 15, D-81671 München

Munich, 1998-01-26

Central Quality Management FS-QZ / Becker



# Customer Support

## Technical support – where and when you need it

For quick, expert help with any Rohde & Schwarz equipment, contact one of our Customer Support Centers. A team of highly qualified engineers provides telephone support and will work with you to find a solution to your query on any aspect of the operation, programming or applications of Rohde & Schwarz equipment.

## Up-to-date information and upgrades

To keep your Rohde & Schwarz equipment always up-to-date, please subscribe to our electronic newsletter at

<http://www.rohde-schwarz.com/www/response.nsf/newsletterpreselection>

or request the desired information and upgrades via email from your Customer Support Center (addresses see below).

## Feedback

We want to know if we are meeting your support needs. If you have any comments please email us and let us know [CustomerSupport.Feedback@rohde-schwarz.com](mailto:CustomerSupport.Feedback@rohde-schwarz.com).

---

### USA & Canada

Monday to Friday (except US public holidays)

8:00 AM – 8:00 PM Eastern Standard Time (EST)

Tel. from USA 888-test-rsa (888-837-8772) (opt 2)

From outside USA +1 410 910 7800 (opt 2)

Fax +1 410 910 7801

E-mail [Customer.Support@rsa.rohde-schwarz.com](mailto:Customer.Support@rsa.rohde-schwarz.com)

### East Asia

Monday to Friday (except Singaporean public holidays)

8:30 AM – 6:00 PM Singapore Time (SGT)

Tel. +65 6 513 0488

Fax +65 6 846 1090

E-mail [Customersupport.asia@rohde-schwarz.com](mailto:Customersupport.asia@rohde-schwarz.com)

### Rest of the World

Monday to Friday (except German public holidays)

08:00 – 17:00 Central European Time (CET)

Tel. from Europe +49 (0) 180 512 42 42

From outside Europe +49 89 4129 13776

Fax +49 (0) 89 41 29 637 78

E-mail [CustomerSupport@rohde-schwarz.com](mailto:CustomerSupport@rohde-schwarz.com)







# Supplement B to Operating Manual SIGNAL GENERATOR SME

## Correction of Data Sheet, Number 757.0358.23

### Models SME03 and SME03E

#### Amplitude modulation:

AM distortion factor at 1 kHz<sup>1)</sup>  
Applies to levels ≤ 7dBm

### Model SME06

Instead of the values quoted in the data sheet, the following specifications of the SME06 apply:

#### Amplitude modulation:

Modulation frequency response (m = 60 %) <sup>1)</sup>

20 Hz (DC) to 50 kHz ..... < 1 dB (f ≤ 3GHz)  
20 Hz (DC) to 10 kHz ..... < 1 dB (f > 3GHz)

### Model SME03A and SME models fitted with option SM-B50

Model **SME03A** and SME<sub>xx</sub> models fitted with **Option SM-B50** are equipped with a high-speed processor which improves the values specified for the setting times. The following specifications are valid:

#### Frequency

Setting time (to within  
<math>1 \times 10^{-7}</math> for f > 130 MHz and  
<math>73</math> Hz für f < 130 MHz)  
after IEC/IEEE-bus delimiter ..... < 3 ms

#### Level

Setting time (IEC/IEEE bus)  
with electronic level setting ..... < 2 ms

#### Sweep

Selectable step time ..... 2 ms to 5 s

#### List mode

Max. number of channels ..... 4000

---

<sup>1)</sup> Does not apply to non-interrupting level setting (ATTENUATOR MODE FIXED)



# 1 Preparation for Use

## 1.1 Putting into Operation

Before putting the SME into operation, please make sure that

- the covers of the casing are put on and screwed,
- the ventilation openings are free,
- no signal voltage levels exceeding the permissible limits are applied at the inputs,,
- the outputs of the instrument are not overloaded or connected incorrectly.

If these points are not observed, the instrument might be damaged.

### 1.1.1 Supply Voltage

The SME can be operated at a.c. systems from 90 to 132 V and 180 to 265 V at system frequencies from 47 to 440 Hz. The power supply socket is situated at the rear of the instrument. The instrument automatically sets itself to the voltage applied within the permissible voltage ranges. It is not necessary to set the instrument to a certain supply voltage.

### 1.1.2 Switching On/Off the Instrument

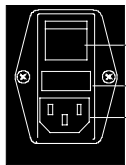

- Power switch
- Fuse holder
- Power supply socket

Switch on/off:

- Press power switch at the top/bottom
- When the instrument is switched off, the marking "O" is visible at the top of the power switch.

The power switch can remain switched on permanently. Switching off is only necessary when the instrument is to be completely disconnected from the mains.

Power switch at the rear of the instrument



Standby check LED

Switch on:

- Press switch.
- The instrument is ready for operation.

Switch off:

- Release switch.
- The instrument assumes the STANDBY mode.

On/off switch at the front of the instrument

### 1.1.3 Initial Status

Upon switching on, the instrument either automatically assumes the status which was set when it was switched off (parameter POWER-ON STATE PREVIOUS SETTING in LEVEL-LEVEL menu) or the RF output is disconnected (POWER-ON STATE RF OFF).

If the instrument need not to be operated from the initial status any further, a defined default status should be established by pressing the [PRESET] key prior to further settings.

#### STANDBY Mode

In the STANDBY mode the optional reference oscillator (option SM-B1) remains switched on, which increases frequency accuracy.

#### Frequency accuracy after switching on when the oven-controlled reference oscillator is fitted (option SM-B1)

When switching on from the STANDBY mode, the specified frequency accuracy is reached immediately. If the power switch was switched off, the reference oscillator needs some minutes of warm-up time to reach its nominal frequency. During this period of time, the output frequency does not yet reach its final value either. In the status line in the header field of the display the message "OVEN COLD" is displayed for this time.

### 1.1.4 Setting Contrast and Brightness of the Display

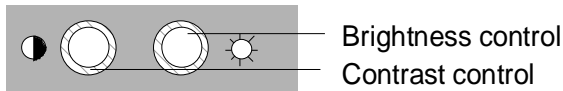

Contrast and brightness of the display can be set by means of the contrast and brightness controls situated below the display.

### 1.1.5 RAM With Battery Back-Up

The SME has a static read-write memory (CMOS-RAM) with battery back-up, in which 50 different complete settings of the instrument can be stored (cf. Chapter 2, section "Storing and Calling of Instrument Settings"). In addition, all data and/or lists the user enters himself, such as for list mode, memory sequence, user correction of the level and data sequences with digital modulation, are stored in the RAM. Further, all data of the calibrations running within the instrument in the SME are stored in the RAM (cf. Chapter 2, section "Calibration").

A lithium battery with a service life of approx. 5 years serves to supply the RAM with power. When the battery is discharged, the data stored will be lost. Exchanging the battery is described in Chapter 4.

### 1.1.6 Preset Setting

A defined setting status is achieved by pressing the [PRESET] key.

#### Preset Status:

RF frequency	100 MHz
RF level	-30 dBm
Reference frequency	internal, adjustment off
Offsets	0
Modulations	switched off
Transient-free level setting	switched off, level attenuator mode: AUTO
Internal level control	level ALC: ON
User correction	level UCOR: OFF
PLL bandwidth	auto
LF output	switched off
Sweep	switched off
List mode	switched off
Memory sequence	switched off
Suppression of indications	system security: unaltered
Protection of calibration data	protection lock: unaltered
Settings stored	unaltered
Data, lists etc. stored	unaltered
IEC-bus address	unaltered
Beeper	unaltered

All parameters and circuit states, even those of operating modes which are not activated, are preset by means of Preset.

The presettings going beyond the above list can be seen from the menu representations as of Section 2.4 which each indicate the Preset setting status.

## 1.2 Functional Test

On switching on the instrument and permanently during operation, the SME carries out a self test. The ROM contents as well as the battery of the non-volatile RAM are checked on switching on the instrument and the RAM contents with every calling the memory. The most important instrument functions are automatically monitored during operation.

If an error is detected, the message "ERROR" is displayed in the status line. For further identification of the error, press the [ERROR] key. Thereupon a description of the error/s is displayed (cf. Chapter 2, section "Error Messages"). Return to the menu exited by pressing the [RETURN] key.

If required, the self tests can be induced purposefully. See Chapter 4, section "Functional Test". Further, internal test points can be polled by the user and the results be read out and displayed. See Chapter 2, section "Voltage Indication of Test Points".

## 1.3 Fitting the Options

Due to its variety of options, the SME offers the possibility of providing the instrument with the equipment exactly corresponding to the application. Newly fitted options are automatically recognized and the relevant parameters added in the menu.

After every change of the instrument configuration, the CMOS RAM has to be cleared as the storage data shift:

- Switch off the instrument
- Switch the instrument on again with the [RESET] key pressed

The internal calibration routines PULSE GEN, YFOM, ALLAMP now have to be called up again to restore the cleared calibration values.

These routines are accessible via menu UTILITIES-CALIB (see also Chapter 2, section "calibration"). The calibration routines have to be carried out in the following order:

1. YFOM
2. ALLAMP
3. PULSE GEN (if installed)

### 1.3.1 Opening the Casing



*Caution:*

*Prior to opening the SME unplug the power connector.*

#### **Remove paneling**

- Remove four screws in the two tilt feet at the rear of the instrument.
- Remove the upper paneling towards the top and rear.
- Turn the instrument.
- Remove the lower paneling towards the top and rear.

#### **Open ventilation ducts**

When an option is fitted at a slot which has not been used up to now, the appropriate ventilation duct of the plexiglas plate at the left in the casing frame must be opened. The openings are pre-punched so that the respective part is easy to break out.

### 1.3.2 Overview of the Slots

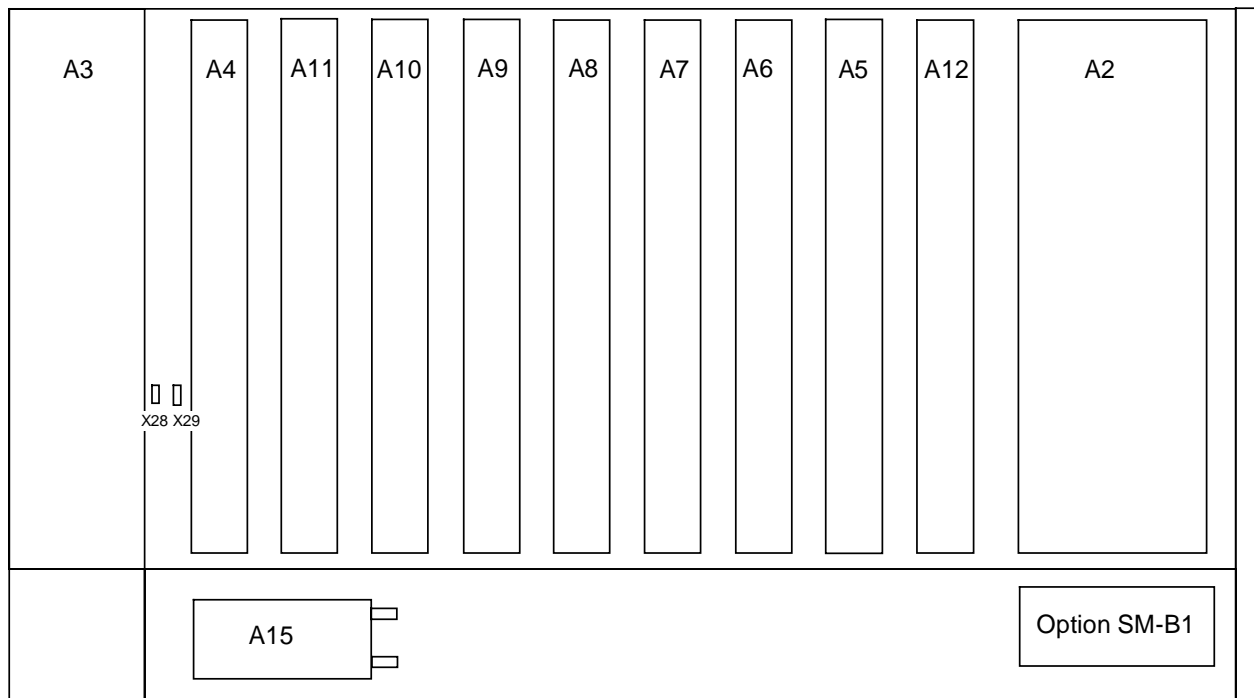

- |                               |                                  |
|-------------------------------|----------------------------------|
| A2 = power supply             | A8 = digital synthesis           |
| A3 = front unit               | A9 = summing loop                |
| A4 = option                   | A10 = output section, 1.5 GHz    |
| A5 = option                   | A11 = output section 3 GHz/6 GHz |
| A6 = option                   | A12 = option                     |
| A7 = reference/step synthesis | A15 = attenuator                 |

Fig. 1-1 SME, View from the top

### 1.3.3 Option SM-B1 - Reference Oscillator OCXO

#### Fitting the option

- Fasten the option at the back end of the lateral opening by means of the screw threads provided there.
- If slots A5 and A6 are both occupied, one of these modules must be removed temporarily.
- Feed ribbon cable W710 through the rear square cut-out to the motherboard, insert into connector X22 and snap in the locking.
- Feed coaxial cable W710 from socket X711 of the option through the second cut-out along the rear transverse panel to connector X74 at the A7 module, reference/step synthesis, via the motherboard and insert there. Fasten the cable at the transverse panel using the cable ties attached.

Set tuning voltage and calibrate OCXO

The crystal oscillator was factory-tuned to nominal frequency and the appropriate tuning voltage indicated on the cover of the module. The calibration value now has to be calculated from this value and transferred to the memory of the signal generator.

Calculate calibration value      The tuning voltage is generated by a 12b-bit-D/A converter which is scaled such that a tuning voltage of 12 volts is generated with calibration value (CALIBRATION DATA) 4000.  
The calibration value is thus calculated from the tuning voltage ( $V_{\text{tun}}$ ) as follows

$$\text{CALIBRATION DATA} = V_{\text{tun}} \times 4000 / 12$$

For checking purposes, the voltage at pin 16 of plug X22 on the motherboard can be remeasured and corrected if necessary. A check by means of frequency measurement may only be made after a warm-up of 2 hours and against a calibrated reference.

Store calibration value      ➤ Call menu UTILITIES-CALIB-REF OSC.  
➤ Enter the calculated calibration voltage with CALIBRATION DATA by means of the rotary knob or keypad.  
➤ Select STORE CALIBRATION DATA  
➤ Terminate entry using the [SELECT] key  
The new calibration value is stored in the EPROM.

**Note:** *The flash EPROM does not permit the deletion of individual data. Thus new memory space is occupied for each calibration. If there is no memory space available any more, the EPROM must be cleared by an authorized service shop and be written into anew. Thus a calibration should only be made if necessary*

### 1.3.4 Option SM-B2 - LF Generator

Fitting as 1st generator      As 1st generator, the LF generator is fitted at one of the rear slots A5, A6 or A12.  
  
➤ Withdraw jumper X29 at the front top of the motherboard.  
➤ Plug jumper X3 at position 2-3 (on the right) on the option (to the right of multipoint connector X50).

Fitting as 2nd generator      If there already is a generator at one of the slots A5, A6 or A12, the LF generator is mounted at slot A4.  
  
➤ Withdraw jumper X28 on the motherboard.  
➤ Plug jumper X3 at position 1-2 on the option.



### 1.3.5 Options SM-B3, SM-B8 and SM-B9 - Pulse Modulator 1.5, 3 and 6 GHz

When fitting this option, the RF characteristics of the instrument change to such an extent that the output level has to be calibrated. This requires calibrated test instruments, a control processor and service kit SM-Z2. For this reason, fitting should be carried out at an authorized R&S service shop. Fitting is described in the service manual (stock number 1039.1856.24).

### 1.3.6 Option SM-B4 - Pulse Generator

The pulse generator is fitted within module A4, pulse modulator.

Fitting the option

- Open module A4.
- Fasten the pulse generator board by means of 4 screws.
- Plug in connectors W10 and W11.
- Screw on cover again.
- Establish the following RF connections at the pulse generator:

Cable	From	To	Signal
W43	A4-X43	Rear panel	VIDEO
W44	A4-X44	Rear panel	SYNC

- Cable 50-MHz reference, cf. Section 1.3.13

Calibrating pulse generator

- Call menu UTILITIES/ CALIB /PULSE GEN
- Select action CALIBRATE ➤ and activate using the [SELECT] key
- The start and end of the calibration are displayed. Calibration only takes a few seconds.

**Note:** The calibration data are stored in the RAM, thus the calibration can be repeated as often as required.

### 1.3.7 Option SM-B5 - FM/PM Modulator

The FM/PM modulator is fitted at slot A6.

Fitting the option

- Withdraw cable W89 from X99 of the summing loop and use again.
- Establish the following connections:

Cable	From	To	Signal
W89	A8-X89	A6-X67	FDSYN
W65	A6-X65	A7-X71	REF100
W67	A6-X69	A9-X99	FDFM

- Adjustment                      Option SM-B5 loads the internal modulation generators so that their output voltage decreases by approx. 1%. This causes a modulation error which can be corrected by the adaptation of the corresponding adjustments. This requires service kit SM-Z2 (stock no.: 1039.3520.02).
- Standard generator              ➤ Press key [PRESET].
- Set LFGEN1 in menu MODULATION / AM / AM SOURCE INT.
- Set the voltage at pin A6 of the plug of the module to 1 V (crest voltage) using R298 (AF LEVEL) .
- Option SM-B2,  
LF generator                      ➤ Press the [PRESET] key.
- Set LFGEN2 in menu MODULATION / AM / AM SOURCE INT.
- Set the voltage at pin A7 of the plug of the module to 1 V (crest voltage) using R55 (1Vp DDS ADJ).
- Option SM-B6,  
Multifunction generator        ➤ Press the [PRESET] key.
- Set LFGEN2 in menu MODULATION / AM / AM SOURCE INT.
- Set the voltage at pin A7 of the plug of the module to 1 V (crest voltage) using R380 (DAC1 AMPL ADJ).
- Press the [PRESET] key.
- Set the following in menu MODULATION / VOR :
- MODE NORM
- VAR DEPTH 0%
- SUBCARRIER DEPTH 0%
- COM/ ID STATE ON
- COM/ ID DEPTH 100%
- Set the voltage at pin A7 of the plug of the module to 1 V (crest voltage) using R465 (DAC2 AMPL ADJ).

### 1.3.8 Option SM-B6 - Multifunction Generator

The multifunction generator is fitted at one of rear slots A5, A6 or A12.

- Undo the board locking on both sides of the motherboard.
- Plug the PCB on one of the slots.
- Lock modules again
- Remove jumper X29 at the front top of the motherboard
- Cable 50-MHz reference, cf. Section 1.3.13

### 1.3.9 Option SME-B11 - DM-Coder

The data coder is fitted into module A8, digital synthesis.

- Open module A8.
- Fasten the DM coder board by means of 4 screws.
  - Caution:** *The four insulating washers supplied have to be placed between the spacers on module A8 and PCB of the option.*
- Plug in connector W1, W2 and W3.
- Screw on cover again.

After fitting the module, the amplitude content and the delay for the DQPSK modulation must be calibrated following the calibrations mentioned in Section 1.3.

Amplitude content

- Allow the SME to warm up.
  - Set 836 MHz in the FREQUENCY menu.
  - Select PRBS in the DIGITAL MOD / DQPSK / SOURCE menu.
  - Select TRIM ON in menu UTILITIES / CALIB / DQPSK AMPLITUDE.
  - Select the following in menu UTILITIES / DIAG / TPOINT
    - TEST POINT 704
    - STATE ON
- The diagnostic point of the ALC control voltage can be switched on.
- Adjust the voltage at this test point to  $0 \pm 4$  mV using potentiometer R297 on module A7, digital synthesis. Adjustment element R297 (LEVEL) can be accessed from the bottom of the instrument without dismantling the module.

## Delay compensation

- Allow the SME to warm up.
- Connect the spectrum analyzer (see Section 5, item 2) to the RF output of the SME.
- SME settings
  - Menu FREQUENCY 836 MHz
  - Menu LEVEL 0 dBm
  - Menu DIGITAL MOD / DQPSK data source PRBS .
- Settings at the spectrum analyzer:
  - Center frequency 836 MHz
  - Span 300 kHz
  - Resolution bandwidth 3 kHz
  - Video bandwidth 100 Hz.
- Check spectrum  
The spectrum should observe the following tolerance limits (the reference level is at the center frequency)

Offset frequency	Level
0 kHz	0 dB (reference level)
30 to 50 kHz	< -40 dB
> 50 kHz	< -50 dB

- Select DELAY in menu UTILITIES / CALIB / DQPSK.
- Adjust the delay such that the spectrum has symmetric spurious sidebands which are as low as possible and observes the tolerance limits.

**Note:** *The delay data are stored in the RAM, thus the calibration can be repeated as often as required.*

If the value for the delay thus found is different from the DEFAULT SETTING stored with R&S, the new value can also be transferred to the EPROM (see note in Section 1.3.3, however)

- Select OVERWRITE DEFAULT SETTING in menu UTILITIES / CALIB / DQPSK.

### 1.3.10 Option SME-B12 - DM Memory Extension

The memory extension is mounted on one of rear slots A5, A6 or A12.

- Undo the board locking on both sides of the motherboard.
- Plug the PCB on one of the slots A5, A6, or A12.
- Fix the board locking.

### 1.3.11 Option SME-B19 - Rear Panel Connections for RF and LF

The SME can be retrofitted to include rear panel connections for RF and LF for mounting it into a 19" rack using option SME-B19. The mounting instructions are attached to the option.

### 1.3.12 Options SME-B41 - FLEX Protocol - and SME-B42 - POCSAG

Options SME-B41 and SME-B42 are software options. They can be enabled by a keyword. The keyword is printed on a label which is part of the equipment supplied and has to be stuck to the rear of SME.

A prerequisite for installing the options is that option SME-B11 (DM Coder, hardware: VAR  $\geq$  4, REV  $\geq$  1) and SME-B12 (Memory Extension, hardware: VAR  $\geq$  2, REV  $\geq$  2) as well as a firmware version  $\geq$  1.95 are part of SME.

Enabling option

- Call up menu UTILITIES-INSTALL and then press key [SELECT].
- Select OPTION TO INSTALL and then press key [SELECT].
- Select option (FLEX or POCSAG) to be installed and then press key [SELECT].
- Enter the 6-digit keyword into the entry field INSTALLATION KEY and then press [ENTER]
- Switch off unit and then switch on again.

After installation, the new option can be checked in the module list in menu UTILITIES-DIAG-CONFIG

### 1.3.13 Cabling of the 50-MHz Reference (REF50)

Instrument without options

Cable	From	To
W72	A7-X72	A8-X81

Instrument with option  
multifunction generator

Cable	From	To
W172	A7-X72	A5--X53
W72	A5-X51	A8-X81

Instrument with option  
pulse generator

Cable	From	To
W41	A7-X72	A4-X41
W72	A4-X42	A8-X81

Instrument with options  
multifunction generator  
and pulse generator

Cable	From	To
W172	A7-X72	A5-X53
W41	A5-X51	A4-X41
W72	A4-X42	A8-X81

## 1.4 Mounting into a 19" Rack

**Caution:** *Ensure free air inlet at the perforation of the side walls and air outlet at the rear of the instrument in rack mounting.*

The SME can be mounted into a 19" rack by means of rack adapter ZZA-94 (stock no. 396.4905.00). The mounting instructions are attached to the adapter .

## 2 Operation

### 2.1 Explanation of Front and Rear Panel

#### 2.1.1 Elements of the Front Panel

##### 2.1.1.1 Display

(cf. Fig. 2-1, A Front panel view, display)

1

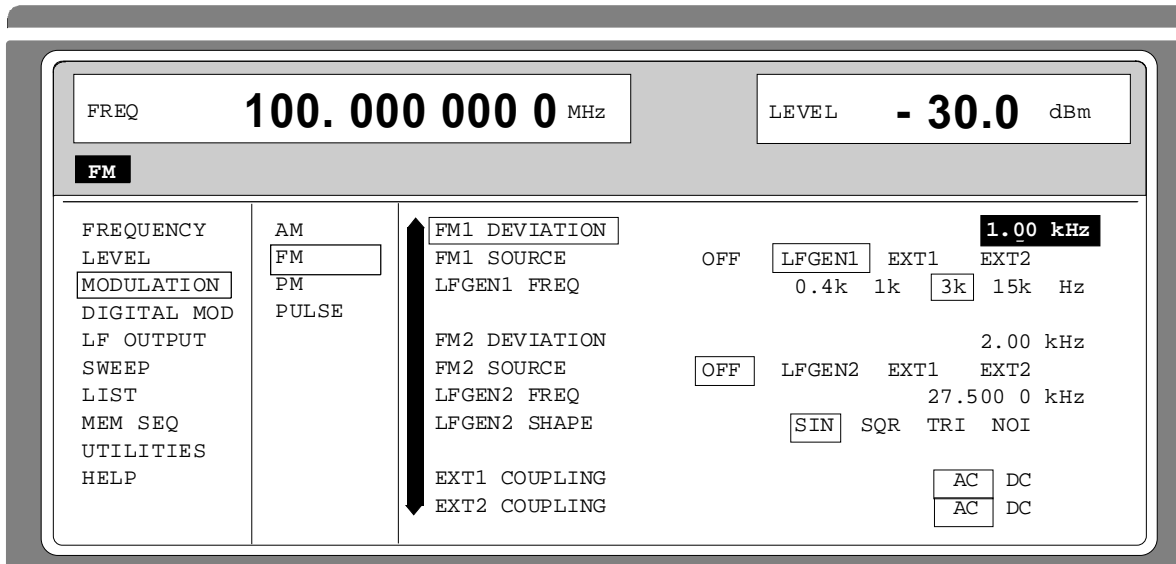

The display shows in the

Header field: - the current frequency and level settings.  
- status messages.  
- error messages.

Menu field: - the main menu and the submenus selected with the current settings.

Parameters can be selected and changed in the menus indicated.

see as well  
Section 2.2.1,  
Display

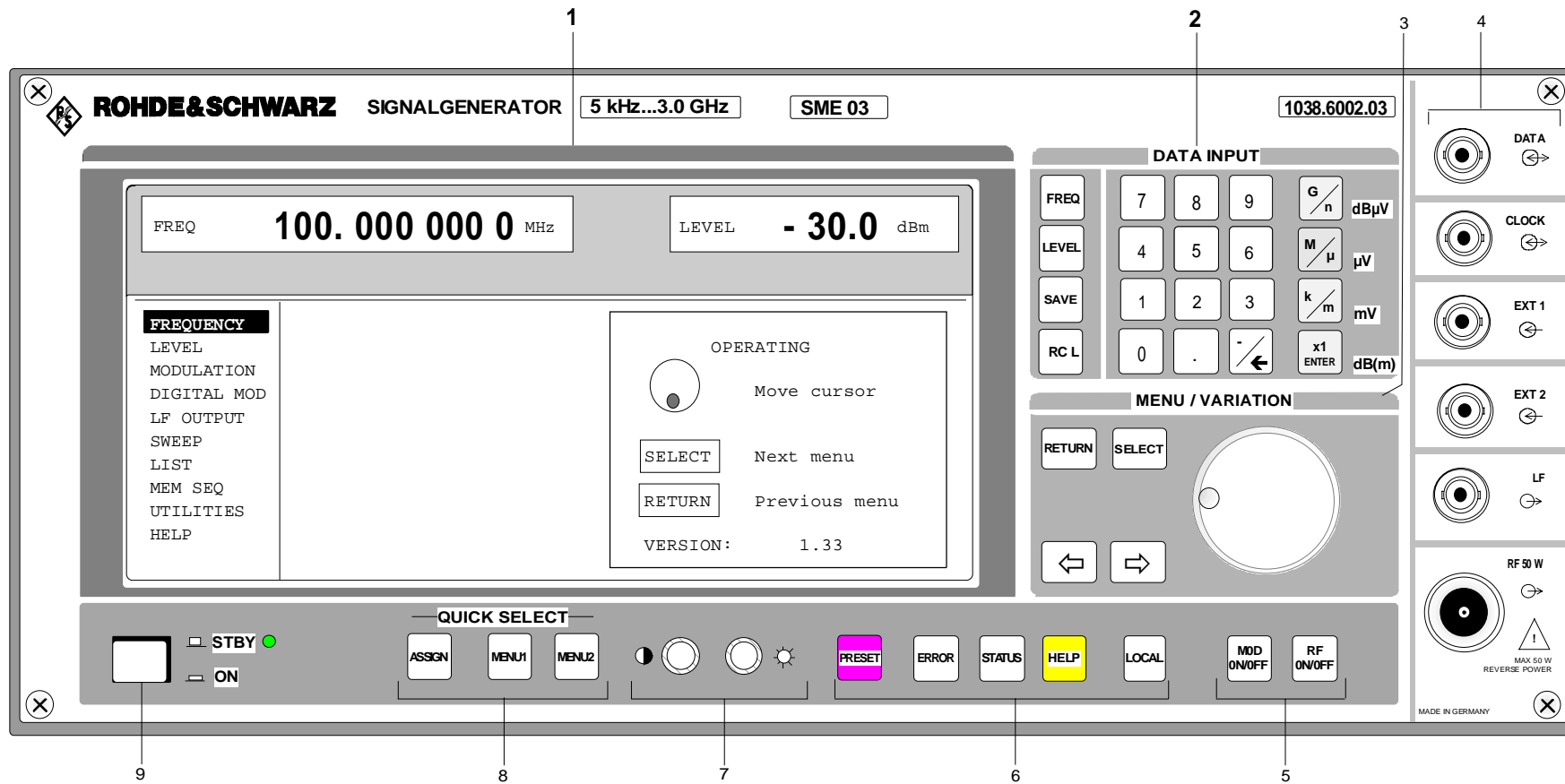

Fig. 2-1,a Front panel view, display



### 2.1.1.2 Controls

(cf. Fig. 2-1, B front panel view, controls)

## 2 DATA INPUT

### Parameter field



Parameters RF frequency and RF level can be entered directly by means of the parameter keys, alternatively to menu operation. Further, complete instrument settings can be stored and called.

- FREQ** Opens the setting of the RF frequency via value input or variation by means of a rotary knob. The current menu is maintained. Return to the menu by means of the [RETURN] key. (Setting of the RF frequency also in the FREQUENCY menu).
- LEVEL** Opens the setting of the RF level via value input or variation by means of a rotary knob. The current menu is maintained. Return to the menu by means of the [RETURN] key. (Setting of the RF level also in the LEVEL menu).
- SAVE** Opens the storing of the current instrument setting. Memory selection is effected by entering a number (1 to 50) and is finished by means of the [ENTER] key.
- RCL** Opens the calling of an instrument setting stored. Memory selection is effected by entering a number (1 to 50) and is finished by means of the [ENTER] key.

see as well  
Section 2.2.2.5,  
Use of [FREQ] and  
[LEVEL] Keys

Section 2.4,  
RF Frequency

Section 2.5,  
RF Level

Section 2.2.5,  
Storing and Calling of  
Instrument Settings

### Numeric input field

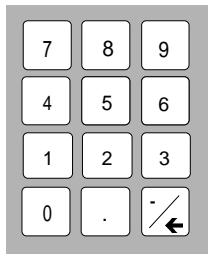

Numeric values, decimal point and minus sign can be entered by means of the digital keys.,

- 0...9 Enters the digit.
- Enters the decimal point
- /← Enters the minus sign.  
Deletes the last input (digit, sign or decimal point) - key [BACKSPACE].

see as well  
Section 2.2.2,  
Basic Operating Steps

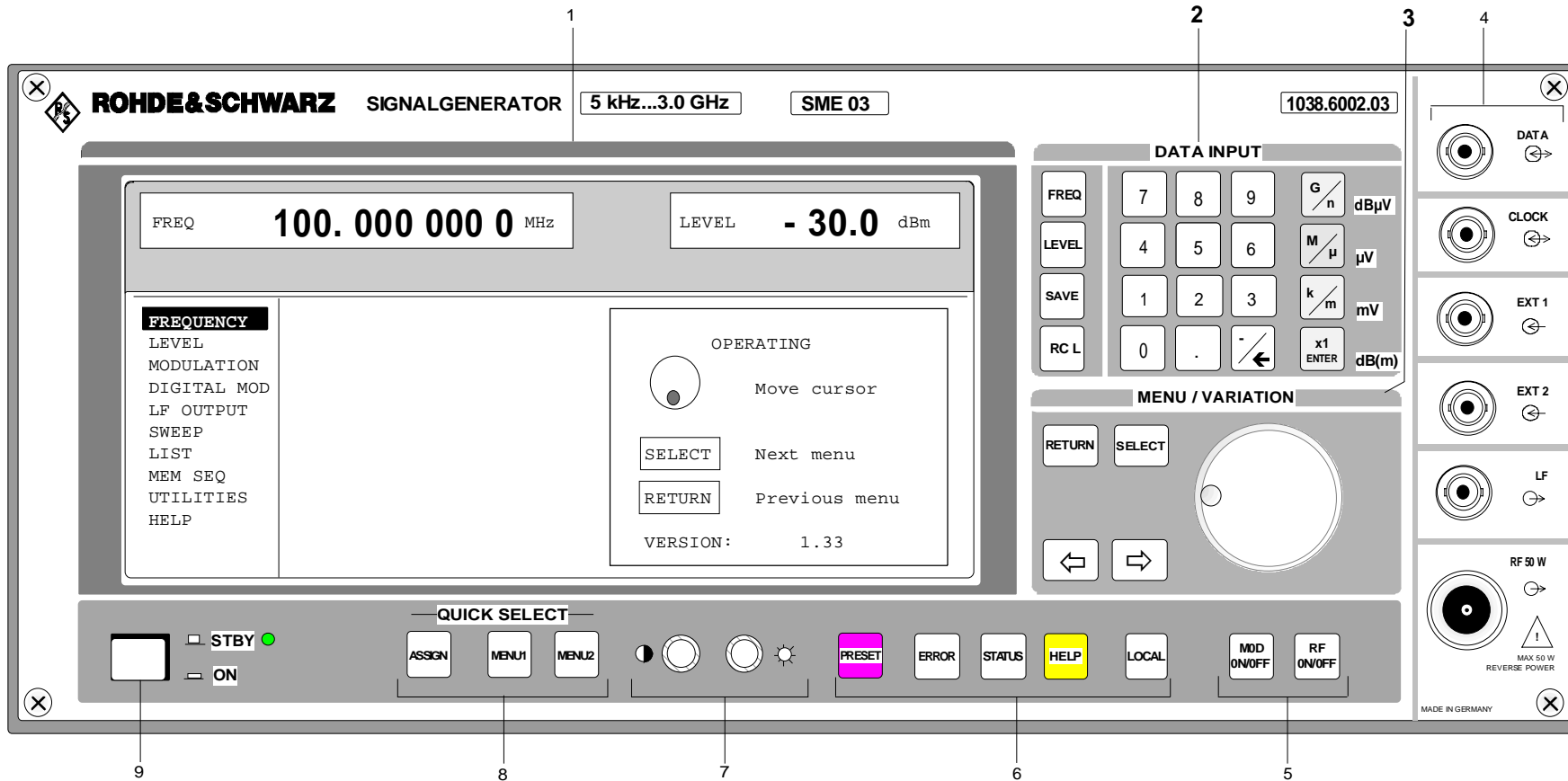
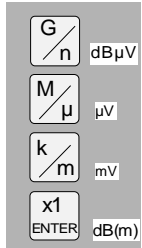

Fig. 2-1,b Front panel view, controls

## 2 DATA INPUT

### Unit keys with enter function



The unit keys terminate the input of values and specify the multiplication factor for the respective basic unit. The basic units are displayed next to the input field while numbers are entered. In the case of level settings, the unit keys specify the unit.

G/n	dBμV	Selects giga/nano, with RF level dBμV, with LF level dBu.
M/μ	μV	Selects mega/micro, with level μV.
k/m	MV	Selects kilo/milli, with level mV.
1x		
Enter	dB(m)	Terminates entries in the basic unit and value inputs without unit. Selects with level dBm Selects with level offset and level step width dB.

In order to change to another level unit, simply press the unit key desired. Parameter LEVEL must be activated, e.g. by pressing the [LEVEL] key.

see as well  
Section 2.2.2,  
Basic Operating  
Steps

Section 2.2.2.7,  
Change Unit of Level

## 3 MENU/VARIATION

### Menu keys

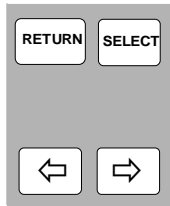

The menu keys access the menus and settings within the menus.

RETURN	Returns the menu cursor to the next higher menu level.
SELECT	Acknowledges the choice marked by the menu cursor
←	Moves the digit cursor to the left by one position in the marked value indication. Moves the menu cursor to the left by one position in a 1-out-of-n selection.
⇒	Moves the digit cursor to the right by one position in the marked value indication. Moves the menu cursor to the right by one position in a 1-out-of-n selection.

see as well  
Section 2.2.2,  
Basic Operating Steps

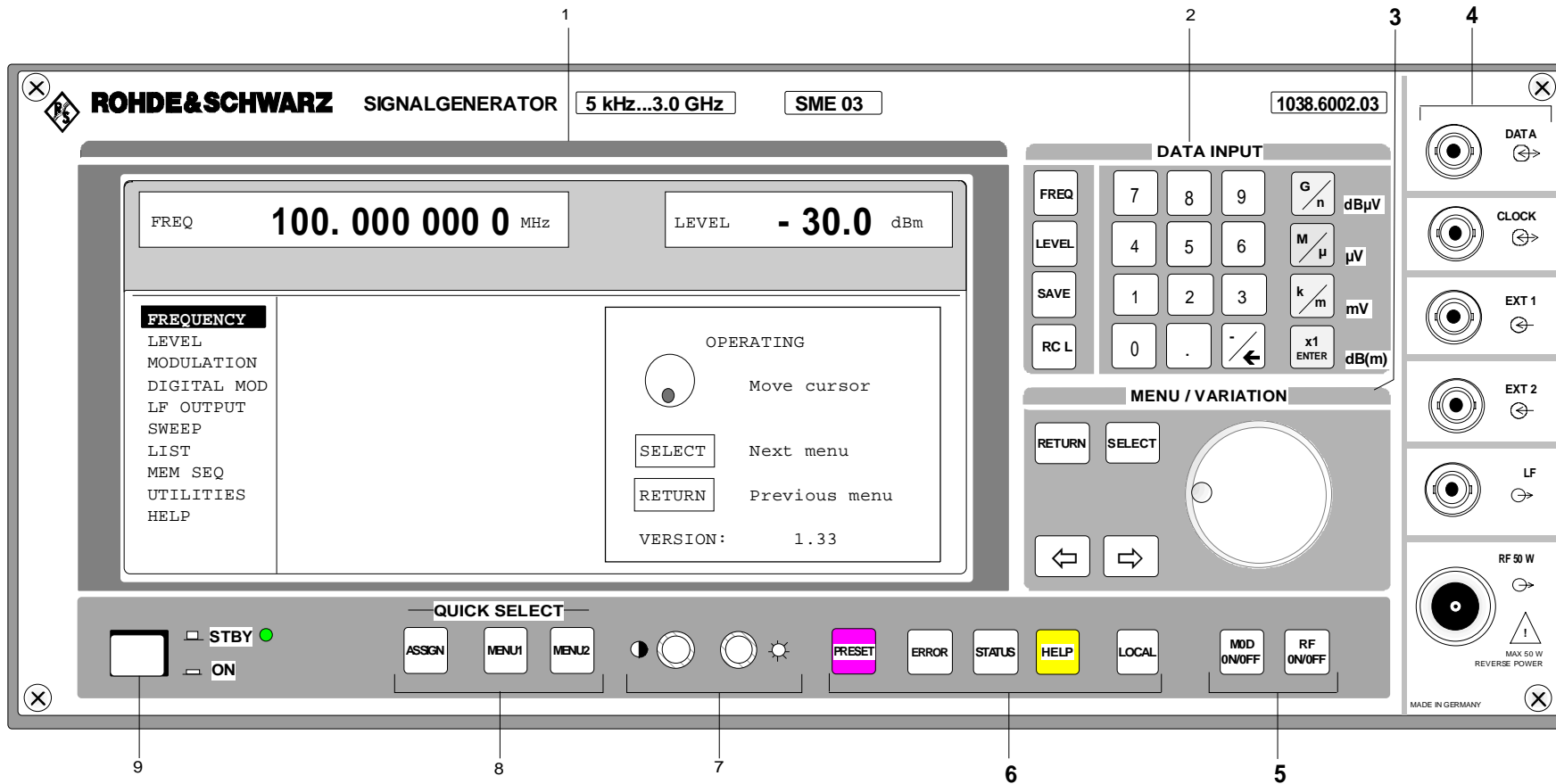
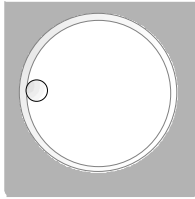

Fig. 2-1,b Front panel view, controls

### 3 MENU/VARIATION

#### Rotary knob



The rotary knob moves the menu cursor over the positions of a menu level to choose from or varies the value of a parameter. The variation is either effected in steps of one or in a step width that can be specified at will.

See as well  
Section 2.2.2,  
Basic Operating Steps  
Section 2.2.3,  
Sample Setting for First  
Users

### 4

See Section 2.1.1.3, page 2.11, Inputs/Outputs.

### 5



RF  
ON/OFF

Switches on/off the RF signal.

MOD  
ON/OFF

Switches on/off the modulation selected in the UTILITIES MOD KEY menu.

See as well  
Section 2.2.2.6,  
Use of [RF ON/OFF]  
and [MOD ON/OFF]  
Keys

### 6

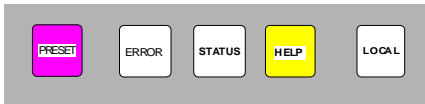

PRESET

Establishes a defined instrument status.

ERROR\*

Indicates error and caution messages.

STATUS\*

Indicates the instrument status.

HELP\*

Indicates context-sensitive auxiliary text.

LOCAL

Switches the instrument from the REMOTE mode (remote control) to the LOCAL mode (manual control).

See as well  
Section 1.1.7,  
Preset Setting

Section 2.12,  
Help System

Section 2.13,  
Status

Section 2.14,  
Error Messages

Section 3,  
Remote Control

\* Exit the menus using the [RETURN] key.

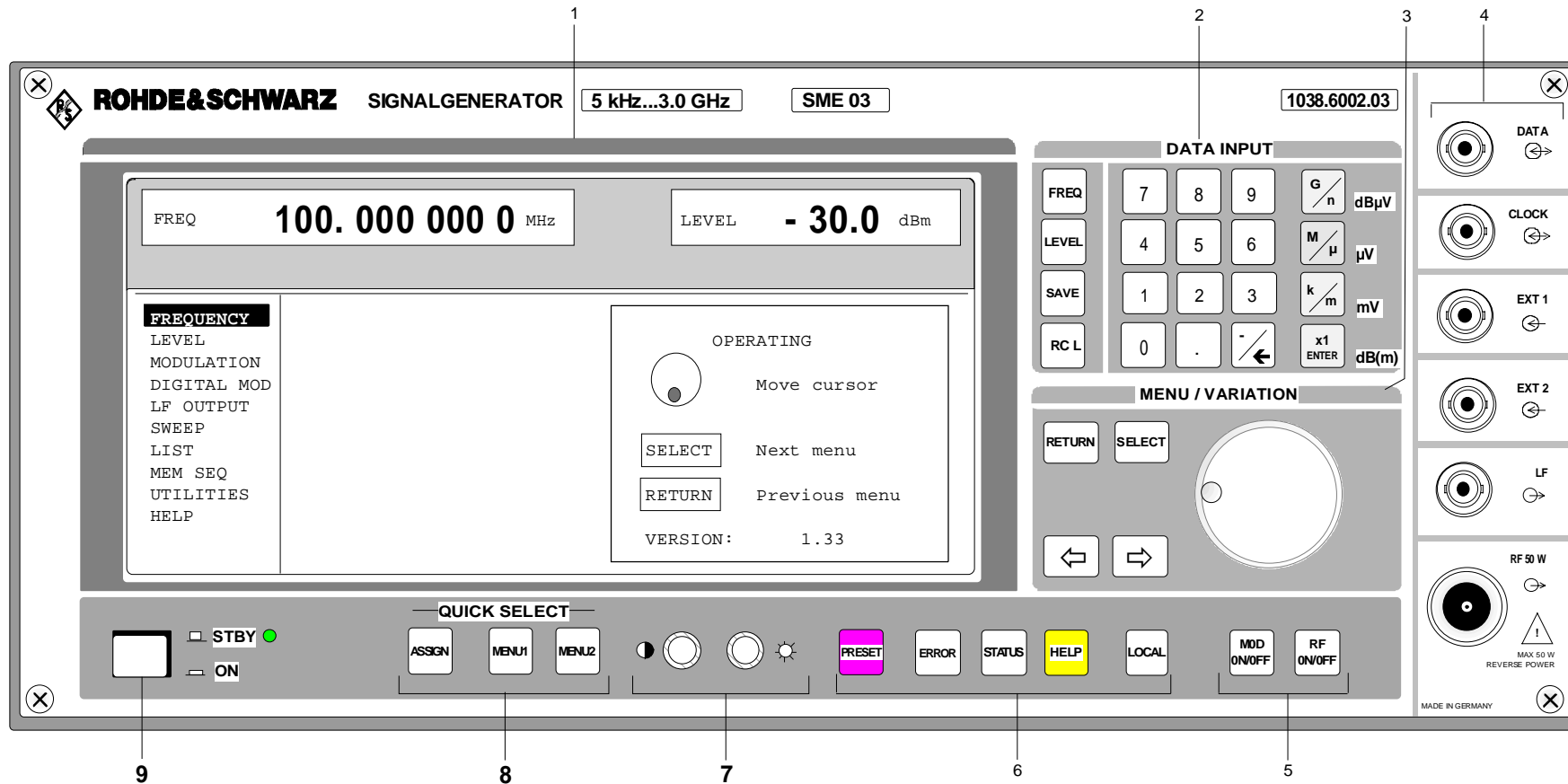

.Fig. 2-1,b Front panel view, controls

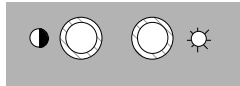

Brightness and contrast of the display can be set using the rotary knobs.



Contrast



Brightness

See as well  
Section 1.1.5,  
Setting of Contrast and  
Brightness of the  
Display

## 8 QUICK SELECT

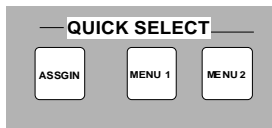

The menu-quick-selection keys permit fast access to two menus selected.

**ASSIGN** Stores the current menu as menu1 when the MENU1 key is pressed afterwards or as menu2 when the MENU2 key is pressed afterwards.

**MENU1** Activates menu1 stored.

**MENU2** Activates menu2 stored.

See as well  
Section 2.2.2, Basic  
Operating Steps

## 9 Switching On/Off

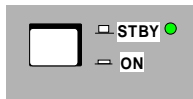

The On/Off switch switches the instrument from the standby mode to the ready-for-operation status. Prerequisite: The power switch at the rear of the instrument must be switched on.

**STBY** LED is illuminated in the standby mode.

see as well  
Section 1.1.3,  
Switching On/Off the  
Instrument  
Section 2.1.2,  
Elements of the Rear  
Panel, Power Switch

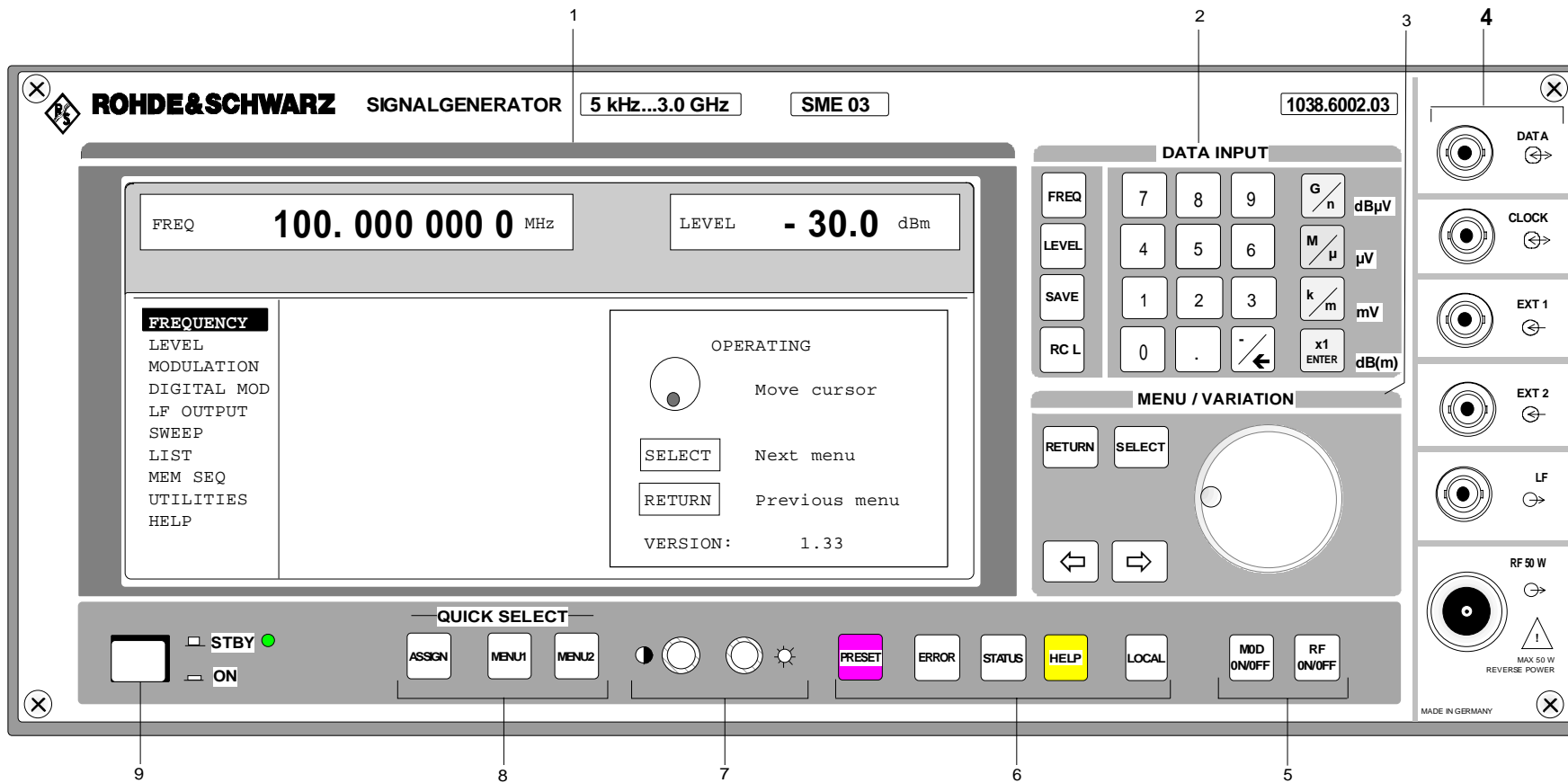







Fig. 2-1,c Front panel view, inputs/outputs



### 2.1.1.3 Inputs/Outputs

(Cf. Fig. 2-1, C Front panel view, Inputs/Outputs)

4

	DATA	Input external data signal for digital modulation. Input resistance 1 k $\Omega$ , TTL-level. Output* data signal with operating mode internal. Level: TTL	See as well Section 2.6.3, Digital Modulation
	CLOCK	Input* external clock-pulse signal for digital modulation. Input resistance 1 k $\Omega$ , TTL-level. Output* clock-pulse signal with operating mode internal. Level:TTL	Section 2.6.3,. Digital Modulation
	EXT 1	Input external modulation signal, alternatively for AM or FM (PM). Input resistance >100 k $\Omega$ . Nominal voltage: $U_s = 1$ V Max. permissible overvoltage: $\pm 15$ V	
	EXT2	Input external modulation signal for FM (PM). Input resistance >100 k $\Omega$ . Nominal voltage: $U_s = 1$ V max. permissible overvoltage: $\pm 15$ V	
	LF	Output** LF signal of the internal LF-generators LF Gen 1 and LF Gen 2. Source resistance < 10 $\Omega$ .	Section 2.7, LF outputs
	RF	Output RF signal. Source resistance 50 $\Omega$	Section 2.2.2.6, Use of [ON/OFF] and [MOD ON/OFF] Key

\* When fitted with option DM-Coder, SME-B11

\*\* Options: SM-B2, SM-B6

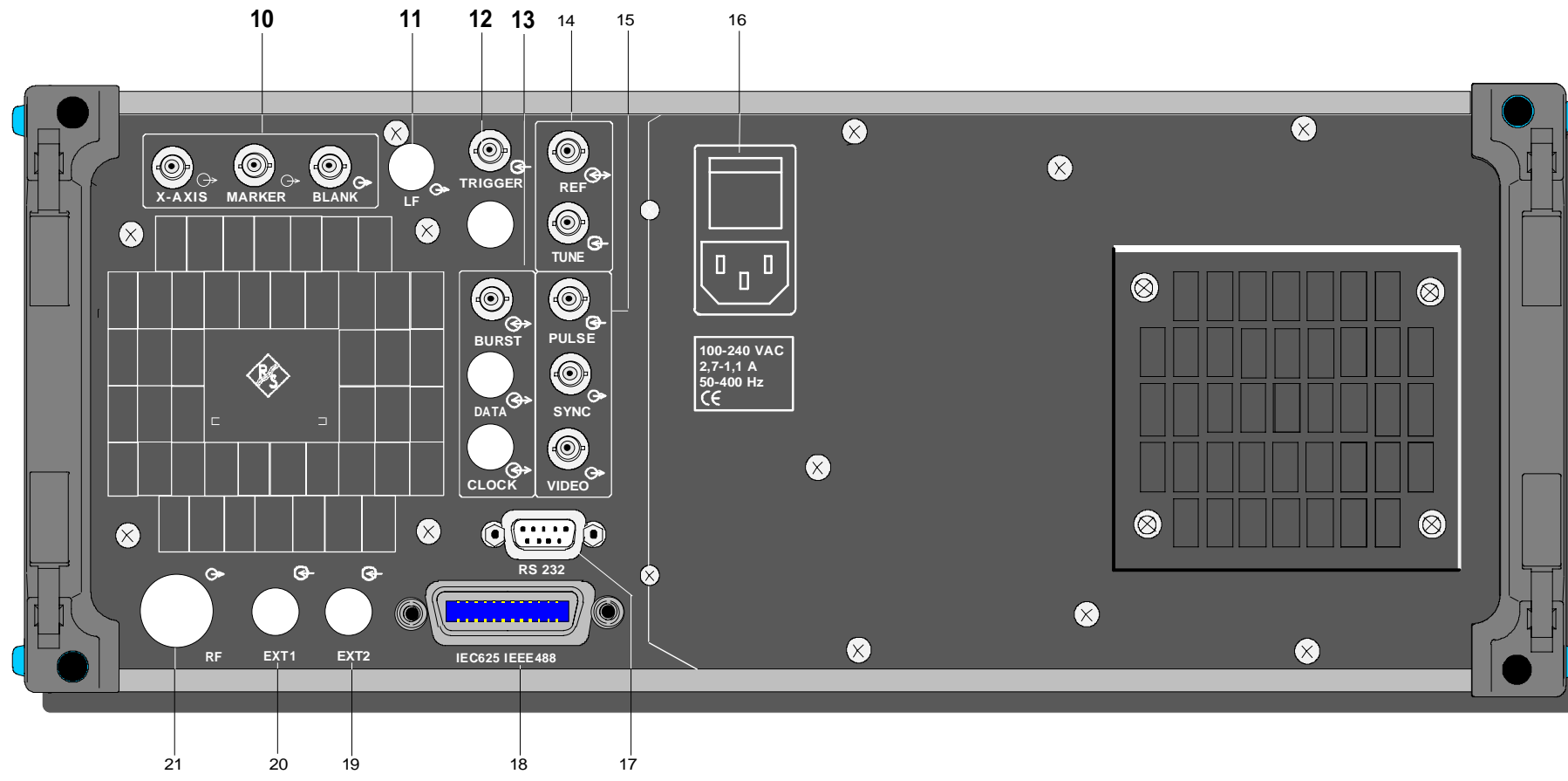

Fig. 2-2 Rear panel view

## 2.1.2 Elements of the Rear Panel

(Cf. Fig. 2-2, Rear panel view)

10



Outputs for control and triggering in the sweep and list operating modes.

X-AXIS Level: 0 to 10 V.

MARKER Level: TTL

BLANK Level: TTL

See as well  
Section 2.8,  
Sweep

Section 2.9,  
LIST Mode

11

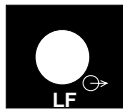

LF Cut-out, provided to relocate the LF output at the front to the rear of the instrument.

12



TRIGGER Input to trigger sweep, memory sequence, LIST mode and DM memory extension.  
Level: TTL

See as well  
respective section as  
to menus and  
Section 2.11.14,  
Input/Output Settings  
(AUX I/O)

13

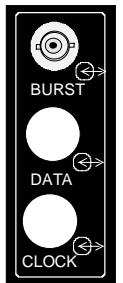

BURST Signal input/output for digital modulation. Signal output for synchronization with data signal generated internally. Level TTL. Signal input in the external operating mode to control level bursts. Level TTL.

DATA Cut-out, provided to relocate the data input/output at the front to the rear of the instrument.

CLOCK Cut-out, provided to relocate the clock input/output at the front to the rear of the instrument.

See as well  
Section 2.6.3,  
Digital Modulation

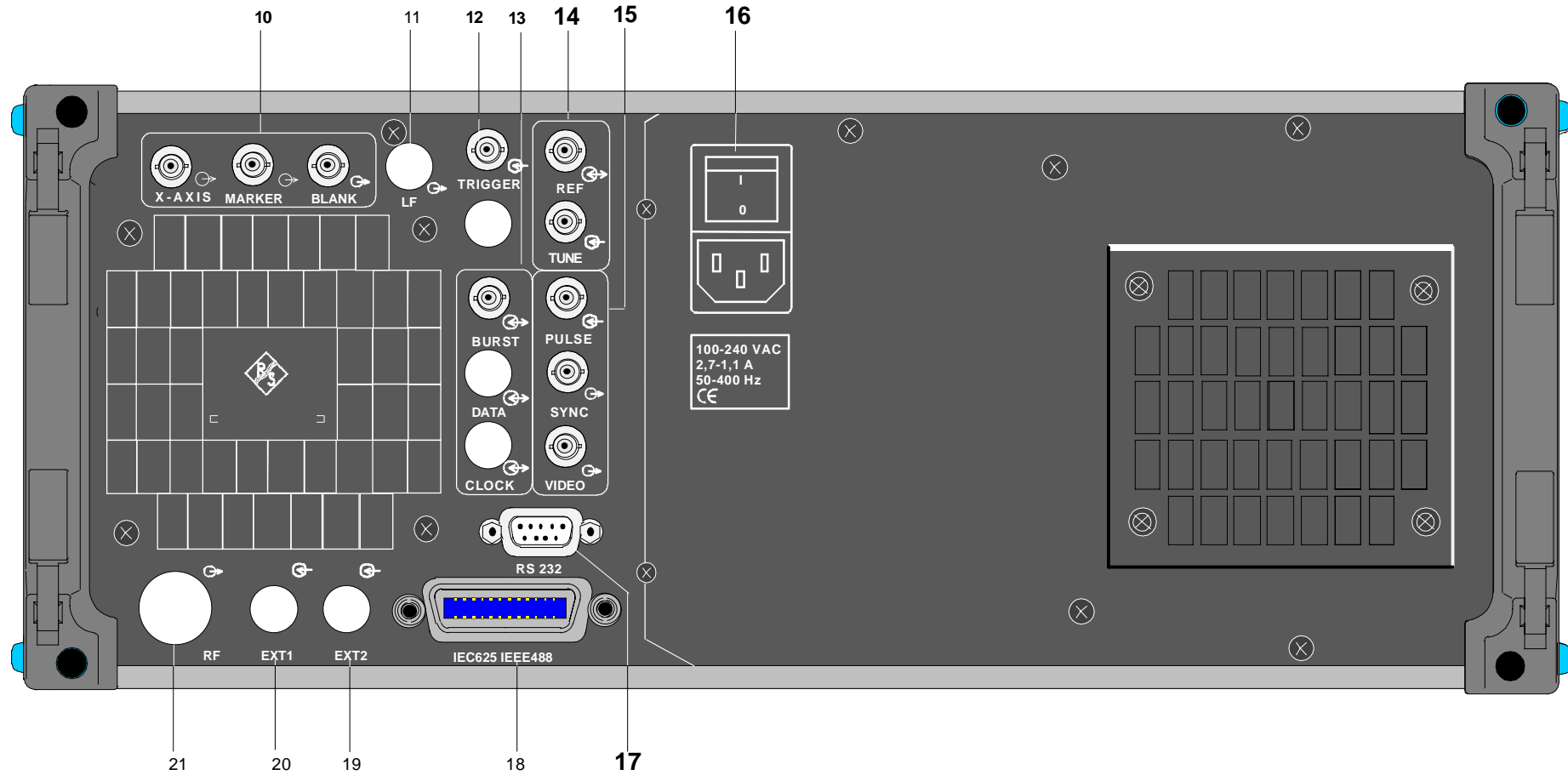
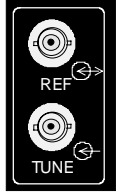

Fig. 2-2 Rear panel view

## 14



REF	Output of the internal 10-MHz reference signal with reference internal. Source resistance 50 $\Omega$ . Input for external reference frequency with reference external. Adjustable to external reference frequencies from 1 MHz to 16 MHz in 1-MHz steps. Input resistance 200 $\Omega$ .
TUNE	Tuning input for the internal reference frequency. Voltage range $\pm 10$ V, pulling range $\pm 1 \cdot 10^{-6}$ .

See as well  
Section 2.11.5,  
Reference Frequency  
Int/Ext

## 15

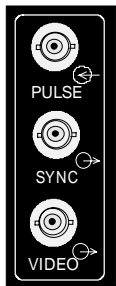

PULSE	Input to trigger the pulse generator or to directly control the pulse modulation. Level: TTL. Input resistance 50 $\Omega$ /10k $\Omega$ , selectable Max. permissible overvoltage: $\pm 15$ V
SYNC	Output SYNC signal with pulse modulation. Level: TTL
VIDEO	Output video signal with pulse modulation. The signal is synchronous with the RF pulse. Level: TTL

See as well  
Section 2.6.2.5,  
Pulse Modulation

## 16

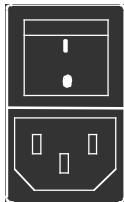

Power switch	On when pressed at the top
Power supply connection	

See as well  
Section 1.1.1,  
Supply Voltage Section  
Section 1.1.3,  
Switching On/Off the  
Instrument

## 17



RS-232	RS-232 interface used for software update, the loading of calibration data, and remote control. The pin assignment corresponds to the pin assignment of a PC.
--------	---

See as well  
Chapter 3,  
Remote Control

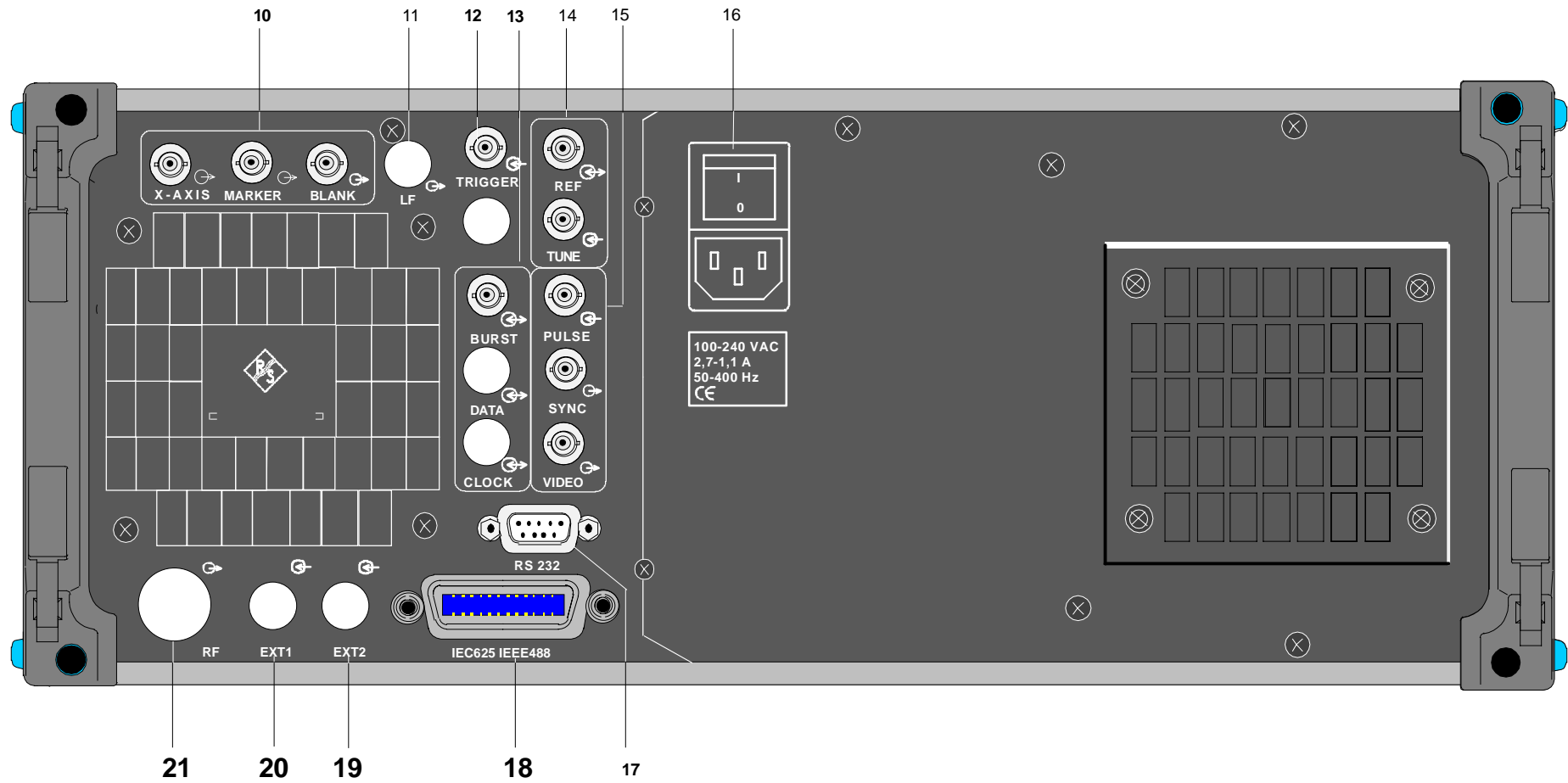
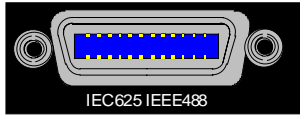

Fig. 2-2 Rear panel view

18



IEC 625 IEC-Bus (IEEE 488)  
IEEE 488 Remote-control interface

See as well  
Chapter 3,  
Remote Control

19



EXT2 Cut-out, provided to relocate the EXT2 input at the front to the rear of the instrument.

20



EXT1 Cut-out, provided to relocate the EXT1 input at the front to the rear of the instrument.

21



RF Cut-out, provided to relocate the RF output at the front to the rear of the instrument.

## 2.2 Operating Concept

### 2.2.1 Display

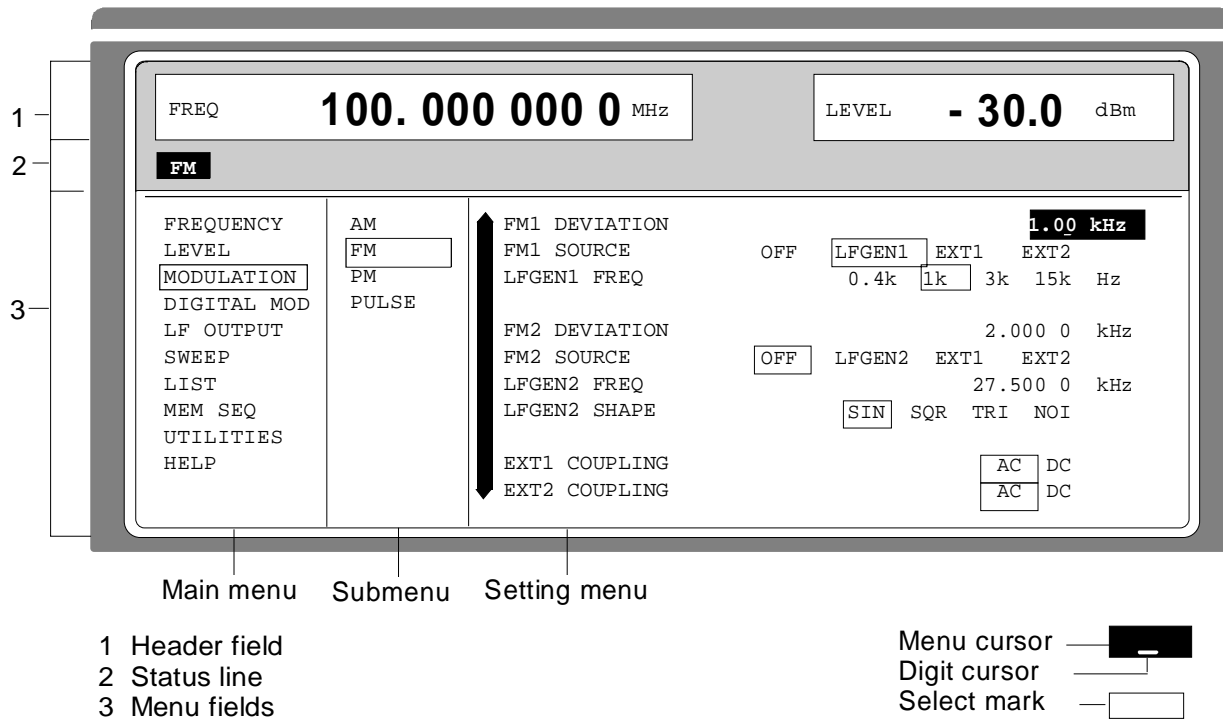

Fig. 2-3 Design of the display

**Header field** (1)The header field of the display indicates frequency and level of the RF output signal. In the RF-sweep operating mode, the start and stop frequencies are displayed in two lines one above the other. The start and stop levels are indicated in the LEVEL-sweep operating mode correspondingly.

**Status line** (2) The status line below describes operating mode and operating state of the instrument. Error messages and notes for caution are also displayed in the status line.

**Menu fields** (3)The indication fields below the header field are reserved for the menu representations. The image contents of these fields change as a function of the menu selected. The field at the left-hand display margin is occupied with the main menu, the topmost level of the menu structure. The main menu is always faded in.

Each further field adjacent at the right contains submenus.

The field ending with the right-hand display margin shows the setting menu. In this menu all setting values and setting states connected with the menu selected are indicated. When accessing submenus, the higher-order menus remain in the display. The current menu path is evident through the select marks.

**Menu cursor** The menu cursor shows the user at which position in the menu he is. The position of the menu cursor is evident from the inverse notation of the term (white characters on a black background)

**Digit cursor** As an underscore, the digit cursor marks the position which can be varied by means of the rotary knob in a value indication.

**Select mark** The frame around a term marks current menus or valid settings in the setting menu.



## 2.2.2 Basic Operating Steps

The operating principle is explained in this section. For better understanding, please read sections "Display" (Section 2.2.1) and "Sample Setting for First Users" (Section 2.2.3) in addition.

To operate the instrument, menus are called in the display. All setting possibilities and the current setting status are evident from the menus. All settings can be made by accessing the menus.

RF frequency and RF level can also be set without menu operation using keys [FREQ] and [LEVEL]. RF signal and modulation can also be switched on/off without menu operation using keys [RF ON/OFF] and/or [MOD ON/OFF].

### 2.2.3.1 Calling the Menus

Accessing the menus is effected using rotary knob [VARIATION], [SELECT] key and [RETURN] key.

**Rotary knob** Rotary knob [VARIATION] moves the menu cursor over the positions of a menu level to be selected.

If a scrollbar is visible at the left-hand margin of a menu, the menu is larger than the screen window. If the menu cursor is moved to the margin of the screen window, the covered lines become visible.

**[SELECT] key** The [SELECT] acknowledges the selection marked by means of the menu cursor.

**[RETURN] key** The [RETURN] key

- returns the menu cursor to the next higher menu level.  
The menu cursor is shifted to the left into the preceding column of the menu structure.
- resets the menu cursor from frequency or level value indication in the header field into the menu field to the menu called last.
- closes the display pages called using keys [STATUS], [HELP] and [ERROR] again.

Settings are accessed in the setting menus ending with the right-hand display margin.

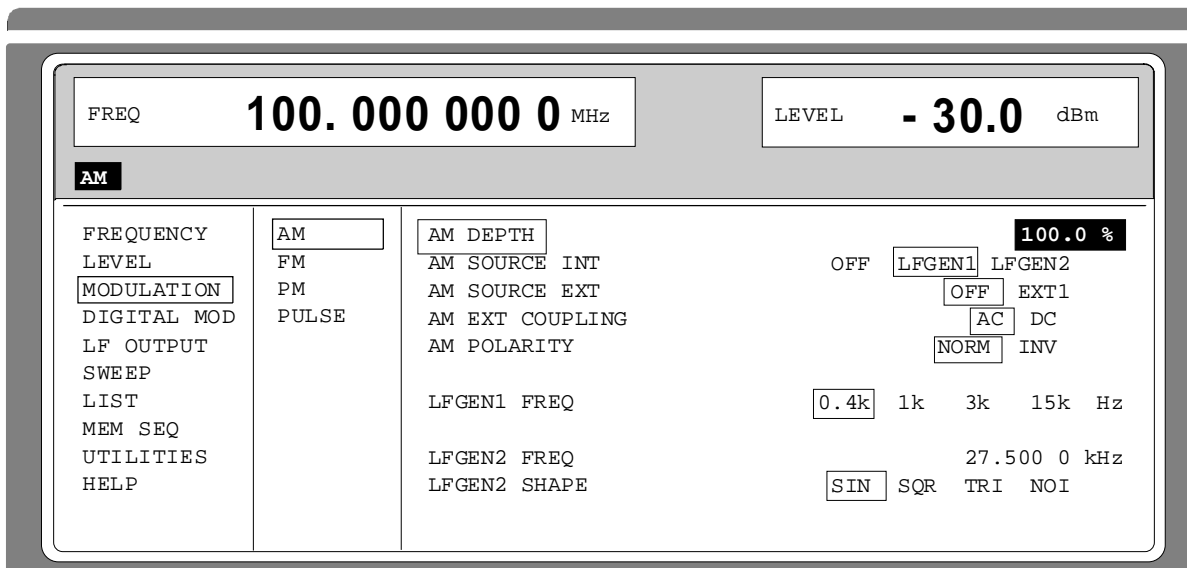

Fig. 2-4 MODULATION-AM menu

### 2.2.3.2 Selection and Change of Parameters

- Select parameter** ➤ Set the menu cursor to the name of the parameter desired using the rotary knob, e.g. to AM DEPTH in the AM menu, Fig. 2.4..
- Change setting value**
- via value inputs
- Via value input or using rotary knob.
  - Press the first digit of the new value or minus sign.  
The old value is deleted, the entry is indicated in the marked field.
  - Enter further digits.
  - Terminate the input using a unit key or, in the case of inputs in the base unit or in the case of inputs without unit, using the [1x/Enter] key.  
The menu cursor wraps back to the appropriate parameter.
- using rotary knob
- Press the [SELECT] key.
  - The menu cursor changes from the parameter selected in the left-hand column of the setting menu to the setting value on the right, e.g. from AM DEPTH to 30%, Fig. 2-4.
  - Set the underscore to the position of the setting value to be varied using keys [⇒] [⇐].
  - Turn the rotary knob.  
The position underscored is varied in steps of 1.
- Note:** *RF frequency and RF level can also be varied in a step width which can be defined arbitrarily using the rotary knob. In the respective setting menu (FREQUENCY or LEVEL) the step width is entered as KNOB STEP USER and the KNOB STEP set from DECIMAL to USER. To point to the fact that the step width has been converted to the value programmed, the underscore as a symbol of the digit cursor disappears in the respective value indication.*
- 1-out-of-n selection**
- Select parameters.
  - Press the [SELECT] key.  
The menu cursor changes from the parameter selected in the left-hand column of the setting menu to the current selection on the right, e.g. from LFGEN1 FREQ to 0.4 kHz, Fig. 2-4.
  - Set the menu cursor to the position desired within the 1-out-of-n selection using the rotary knob or cursor keys [⇐] [⇒].
  - Press the [SELECT] key.  
The setting is made.  
The selection mark which has marked the setting valid up to now wraps to the new position.
  - Press the [RETURN] key.  
The menu cursor wraps back to the respective parameter

**Quick selection of a parameter**

The quick selection of a parameter reduces the number of operating steps if several parameters are set successively. The menu cursor can directly be set further from line to line in the column of the setting values by pressing the [SELECT] key.

The menu cursor wraps from the setting value of a parameter to the setting value of the parameter in the next line.

The column of the setting values can be exited at each position by pressing the [RETURN] key.

**2.2.3.3 Triggering Action**

Lines in the setting menu which are marked with the "➔" symbol at the end of the line qualify an action which can be carried out. Instruction SEARCH ONCE ➔ in the LEVEL-ALC menu, e.g., switches on level control for level calibration for a short period of time.

**Trigger action**

- Set the menu cursor to the respective instruction.
- Press the [SELECT] key.  
The action is triggered.  
While the action is carried out, the instruction remains framed by the selection mark.

**2.2.3.4 Quick Selection of Menu (QUICK SELECT)**

The keys of the QUICK SELECT control field are used to call selected menus quickly by one keystroke.

**Store menus**

- Establish the desired operating status of the current menu.
- Press the [ASSIGN] key.
- Press key [MENU1] or [MENU2].  
The current menu is stored as menu1 or menu2. That is to say, 2 menus can be stored in total.

**Call menus**

- Press key [MENU1] or [MENU2].  
Menu1 or menu2 stored is displayed. Exactly the operating status which was current at the point of time of storing is reconstructed.

### 2.2.3.5 Use of [FREQ] and [LEVEL] Keys

RF frequency and RF level can be set without menu operation as well using direct keys [FREQ] and [LEVEL]. The input value considers the offset, see Sections 2.4 and 2.5.

- Key [FREQ]/ [LEVEL]**
- Press the [FREQ] or [LEVEL] key.
    - The frequency and/or the level indication in the header field of the display is marked.
    - The current menu at the display is maintained.
  - Alter the value via a value input or the rotary knob.
  - Press the [RETURN] key.
    - The menu cursor wraps to the position marked last in the menu.

### 2.2.3.6 Use of [RF ON / OFF] and [MOD ON / OFF] Keys

RF signal and modulation can be switched on/off without menu operation as well using direct keys [RF ON / OFF] and/or [MOD ON / OFF] (see Section 2.6.1.3, [MOD ON/OFF] key as well).

- Key [RF ON / OFF]**
- Press the [RF ON / OFF] key.
    - The RF output signal is switched on/off.
- IEC-bus command:       :OUTP:STAT ON

- Key [MOD ON / OFF]**
- Press the [MOD ON / OFF] key.
    - The modulation is switched on/off.
- A direct IEC-bus command is not available. The modulations have to be switched on and off in the respective modulation submenus.

### 2.2.3.7 Changing Unit of Level

For the level, the unit of the value set can be changed without a new value input.

- Change level unit**
- Activate LEVEL parameter.
    - Press the [LEVEL] key or
    - set the menu cursor in the LEVEL menu to the setting value of the AMPLITUDE parameter.
  - Press the unit key with the desired level unit.
    - The level is indicated in the desired unit.

### 2.2.3.8 Correction of Input

Digital entries can be corrected by one of the unit/Enter keys before terminating the input.

**Key [-/←]** The backspace key deletes the value entered digit by digit. When the last digit is deleted, the previous value is displayed.

**Key [RETURN]** Pressing the [RETURN] key deletes the entire entry and results in the previous value being indicated again.

For a subsequent new input in the setting menu, the first digit of the new value is to be entered.

For a subsequent new input via the [FREQ] or [LEVEL] keys, the respective key has to be pressed again.



**Key [FREQ]/ [LEVEL]** In the case of a frequency or level input by means of the [FREQ] or [LEVEL] keys, pressing the [FREQ] and/or [LEVEL] key again deletes the entire input.

### 2.2.4 Sample Setting for First Users

First users most quickly become familiar with the operation of the instrument if they execute the pattern setting of this section.

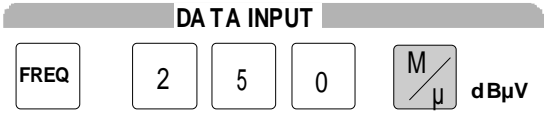
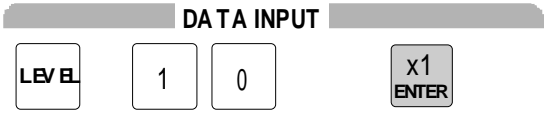

First frequency and level of the RF output signal are set via keys [FREQ] and [LEVEL] in the DATA INPUT field:



- Frequency 250 MHz
- Level 10 dBm

Operating steps	Explanations
	Reset the instrument to the defined state.
	Set the frequency to 250 MHz. The menu cursor marks the permanent frequency indication.
	Set the level to 10 dBm. The menu cursor marks the permanent level indication.
	Reset the menu cursor to the menu field.

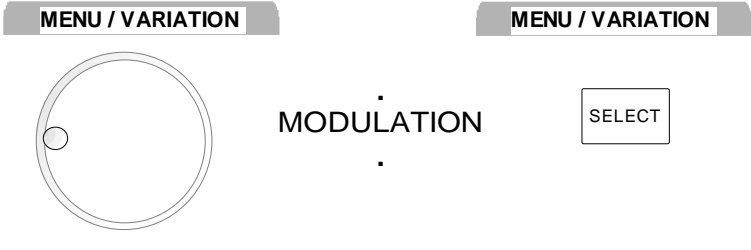
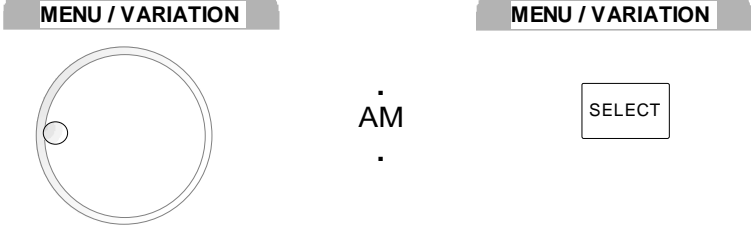
The output signal is to be amplitude-modulated next.

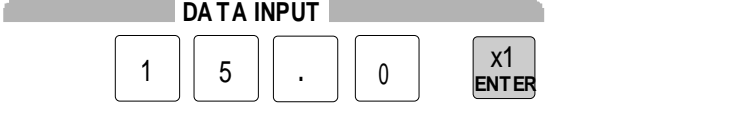
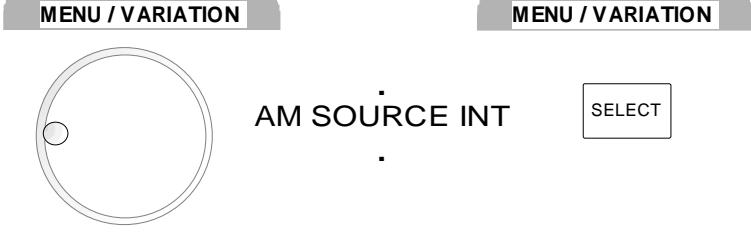
- AM modulation depth 15.5 %
- AM signal 3-kHz sine

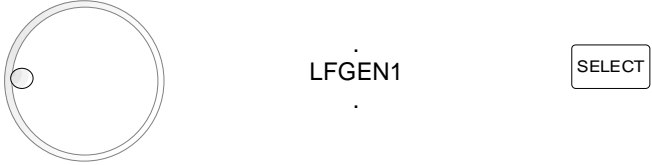
Operating steps	Explanations
	<p>Select MODULATION menu.</p> <p>➤ Set menu cursor to MODULATION using the rotary knob and subsequently press [SELECT] key.</p> <p>The submenu is displayed</p>
	<p>Select AM submenu</p> <p>The AM setting menu is displayed.</p>
	<p>Select AM DEPTH parameter.</p> <p>The menu cursor marks the setting value.</p>
	<p>Enter modulation depth 15.5 % and acknowledge.</p> <p>The menu cursor is reset to AM DEPTH.</p>
	<p>Select AM SOURCE INT.</p> <p>The menu cursor marks the current 1-out-of-n selection.</p>

Operating steps	Explanations
<p>MENU / VARIATION</p> 	<p>Select LF generator 1 as modulation source.</p> <p>The selection mark marks LFGEN1. AM is faded in the status line as a hint that AM is switched on.</p>
<p>RETURN</p>	<p>Reset menu cursor to AM SOURCE INT.</p>
<p>MENU / VARIATION</p> 	<p>Select parameter LFGEN1 FREQ.</p> <p>The menu cursor marks the current frequency selection.</p>
<p>DATA INPUT</p> 	<p>Set the frequency of LF generator 1 to 3 kHz.</p> <p>The selection mark marks 3 kHz.</p> <p>The indications on the display are represented in Fig. 2-5.</p>

The AM modulation setting is completed.

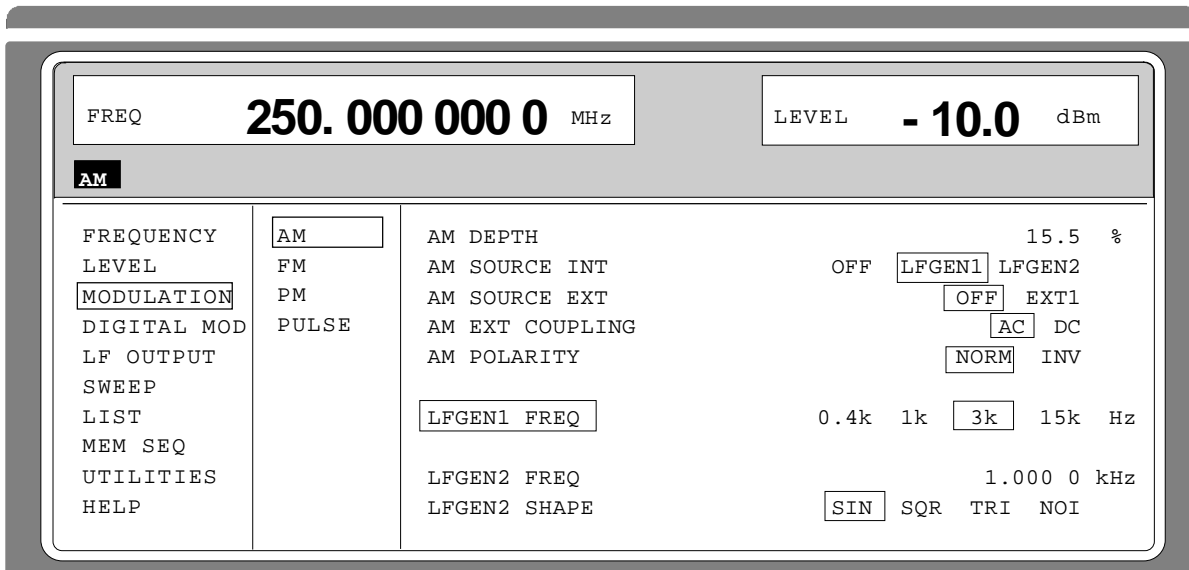

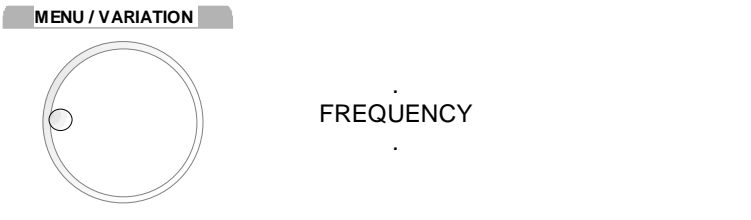
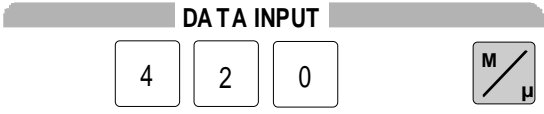

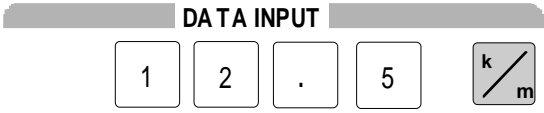





Fig. 2-5 Display after AM setting

Subsequently to the above setting, 420 MHz as new RF frequency and 12.5 kHz as the step width for the RF frequency variation are set in the following. Parameter quick select is used, which reduces the number of operating steps.

Operating steps	Explanations
	Reset the menu cursor to the main menu in 2 steps.
	Select FREQUENCY menu. The frequency setting menu is displayed.
	Select FREQUENCY parameter. The menu cursor marks the setting value.
	Enter frequency 420 MHz and acknowledge.
	Set menu cursor to the setting value of parameter KNOB STEP USER.
	Enter step width 12.5 kHz.
	Set menu cursor to parameter KNOB STEP



Operating steps	Explanations
 <p>MENU / VARIATION</p> <p>. USER .</p> <p>SELECT</p>	<p>Select USER (user-defined step width).</p> <p>The selection mark marks USER.</p> <p>This results in step width 12.5 kHz being used in the case of variation using the rotary knob.</p>
 <p>RETURN</p> <p>RETURN</p>	<p>Reset the menu cursor to the main menu in 2 steps.</p>

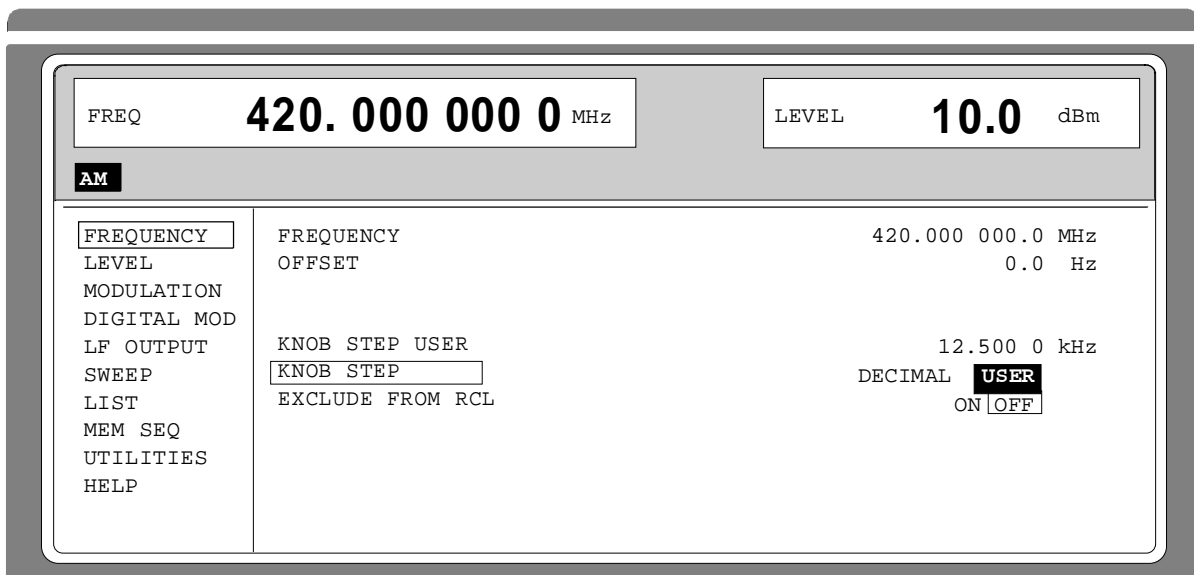

Fig. 2-6 Display after pattern setting

## 2.2.4 List Editor

The SME offers the possibility to generate lists. Lists are used for setting sequences (LIST mode or memory sequence), as data source for digital modulations or for level correction which can be defined by the user (UCOR). They consist of elements which are defined by an index and at least one parameter per index. Each list is marked by a separate name and can be selected via this name. The lists are accessed in the menus assigned in each case, e.g. to the settings sequences of frequency and level value pairs in the LIST menu. However, the lists are always generated and processed in the same way and the procedures are hence explained in detail by the example of the memory sequence mode (menu MEM SEQ) in this section. A pattern setting at the end of this section allows the user to become familiar with the operation of the list editor.

Setting menus providing list processing are structured in two pages:

The first page, called OPERATION page in the following contains the general configuration parameters for processing a list. Further, the general list functions such as selecting and deleting the list as well as calling an editing mode are provided. The second page, the EDIT page, is automatically displayed when calling an edit function and serves to enter and modify the parameters of the list.

The OPERATION page has a similar arrangement with all list editors. As an example, the OPERATION page of the MEM SEQ menu is shown:

Menu selection: MEM SEQ

FREQ	100.000 000 0 MHz	LEVEL	- 30.0 dBm
FREQUENCY	<b>MODE</b>	<input type="checkbox"/> OFF	<input type="checkbox"/> AUTO <input type="checkbox"/> SINGLE <input type="checkbox"/> STEP <input type="checkbox"/> EXT-SINGLE <input type="checkbox"/> EXT-STEP
LEVEL	RESET SEQUENCE		▶
MODULATION	CURRENT INDEX		1
DIGITAL MOD	SELECT LIST...		CURRENT: MSEQ2
LF OUTPUT	DELETE LIST...		
SWEEP	FUNCTION		<input type="checkbox"/> FILL <input type="checkbox"/> INSERT <input type="checkbox"/> DELETE <input type="checkbox"/> EDIT/VIEW
LIST			
<b>MEM SEQ</b>			
UTILITIES			
HELP			

Fig. 2-7 OPERATION page of the MEM SEQ menu

The settings for MODE, CURRENT INDEX, etc. are irrelevant for the general description of the list editors and are described in greater detail in Section 2.10, MEMORY SEQUENCE mode.

The last three menu lines of the OPERATION page always exist and are reserved for selecting and deleting lists as well as for calling the edit functions (and hence the EDIT page)

**SELECT LIST** Opens a selection window in which a list can be selected from the existing lists or a new, empty list can be generated. In this line the active list is always displayed.

**DELETE LIST** Opens a selection window in which the list to be deleted can be selected..

<b>FUNCTION</b>	Selection of the edit function for processing the lists. The EDIT page is automatically called through the selection (cf. Section 2.2.4.3).
FILL	Filling a list with elements.
INSERT	Insertion of elements into a list.
DELETE	Deletion of elements of a list.

### 2.2.4.1 Select and Generate - SELECT LIST

SELECT LIST opens a selection window in which either an existing list can be selected or a new, empty list can be generated (cf. Fig. 2-8). By pressing the [RETURN] key, the selection window is closed without changing the setting.

- |                                |  |
|--------------------------------|--|
| Select list                    | <ul style="list-style-type: none"> <li>➤ Mark the list desired using the rotary knob.</li> <li>➤ Press [SELECT] key.</li> </ul> <p>The selected list is included in the instrument setting. The selection window is closed. The selected list is displayed under CURRENT.</p>                              |
| Generate list                  | <ul style="list-style-type: none"> <li>➤ Mark CREATE NEW LIST ► using rotary knob.</li> <li>➤ Press [SELECT] key.</li> </ul> <p>A new empty list is automatically generated which can be filled using functions FILL or EDIT. The selection window is closed. The new list is displayed under CURRENT.</p> |
| No modification of the setting | <ul style="list-style-type: none"> <li>➤ Press [RETURN] key.</li> </ul>  |

Selection: DELETE

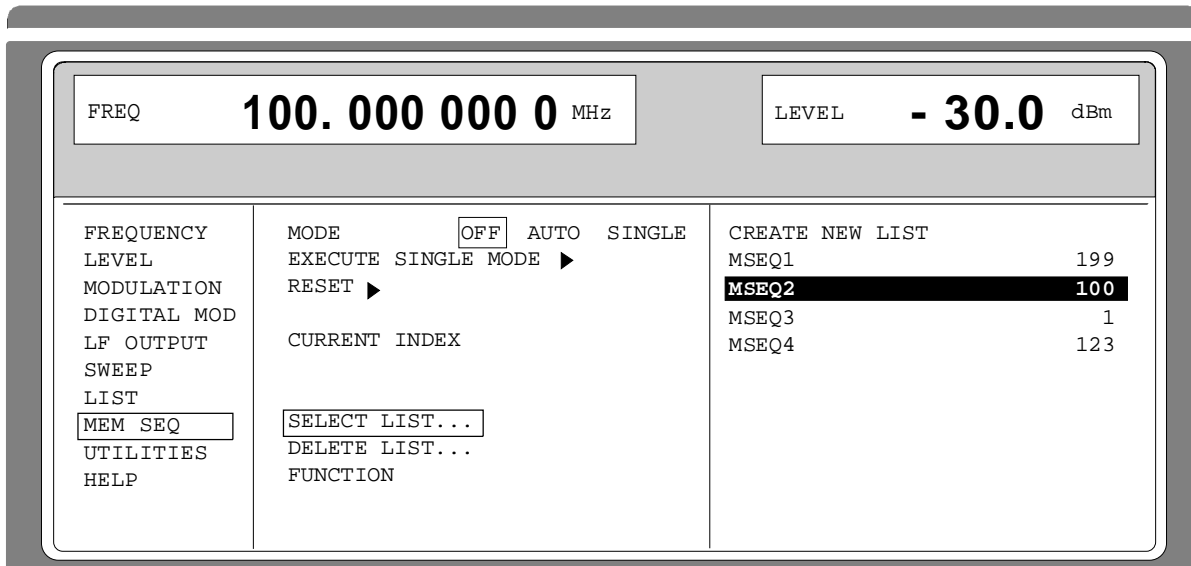

Fig. 2-8 SELECT-LIST-selection window

**CREATE NEW LIST** → Generating a new list. The name of the list cannot be selected freely in the case of manual control. A definite list name is automatically generated in the following form:

MSEQ<n>, with <n> ∈ {0..9}, e.g. MSEQ1 (with Memory Sequence)

This applies correspondingly to the other operating modes. In the case of LIST mode, LIST1 would be generated for example. If a list is created via IEC bus, an arbitrary list name can be given (cf. Section 3). Unrestricted access is also possible by means of the selection window.

**MSEQ2 100**

The list currently set is marked in the selection window by means of the selection mark, here SEQ2. In addition to the list name, the length of the list is given, here 100 elements.

### 2.2.4.2 Deletion of Lists - DELETE LIST

DELETE LIST opens a selection window in which the list to be deleted can be selected.. The lists are represented together with their name and their length (cf. Fig. 2-9). By pressing the [RETURN] key the selection window is exited without deleting a list.

Delete list

- Mark desired list using the rotary knob.
- Press [SELECT] key.  
The prompt "enter [SELECT to delete list/sequence?" is displayed
- Press [SELECT] key.  
The list is deleted. If the prompt is acknowledged with the [RETURN] key, however, the list is not deleted. The selection window is automatically closed due to the acknowledgment of the prompt.

Selection: DELETE LIST

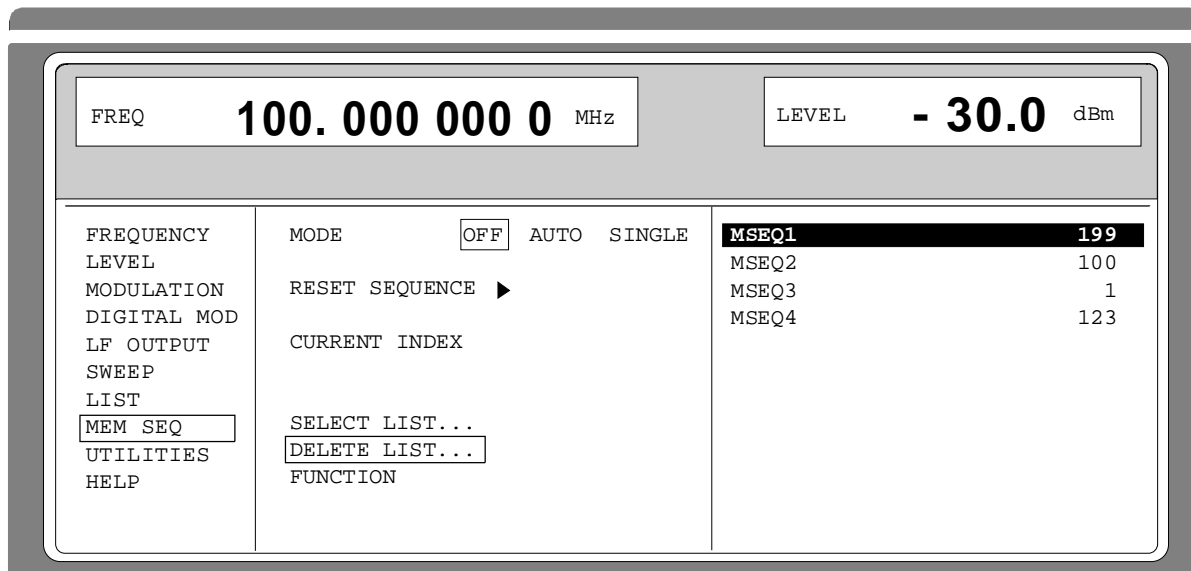

Fig. 2-9 DELETE-LIST selection window

### 2.2.4.3 Edition of Lists

Due to the selection of an edit mode on the OPERATION page the EDIT page is automatically activated. When the EDIT/VIEW function is selected, the largest possible section of the list is displayed (cf. Fig. 2-10). In the case of block functions FILL, INSERT and DELETE, an input window is additionally displayed (cf. Fig. 2-11 to 2-13).

Functions SELECT LIST and FUNCTION are available on the EDIT page as on the OPERATION page. Return to the OPERATION page is effected by pressing the [SELECT] key twice.

#### Single-value function EDIT/VIEW

By selecting the EDIT/VIEW function, the entire list can be viewed or modifications of single values be carried out.

If the cursor marks a value in the INDEX column of the list, the EDIT mode is exited by pressing the [RETURN] key. The menu cursor then marks FUNCTION again.

There is no separate function for storing the list. This means that every modification of the list is transferred to the internal data set and has an effect on exiting the EDIT/VIEW function.

Selection: FUNCTION EDIT/VIEW

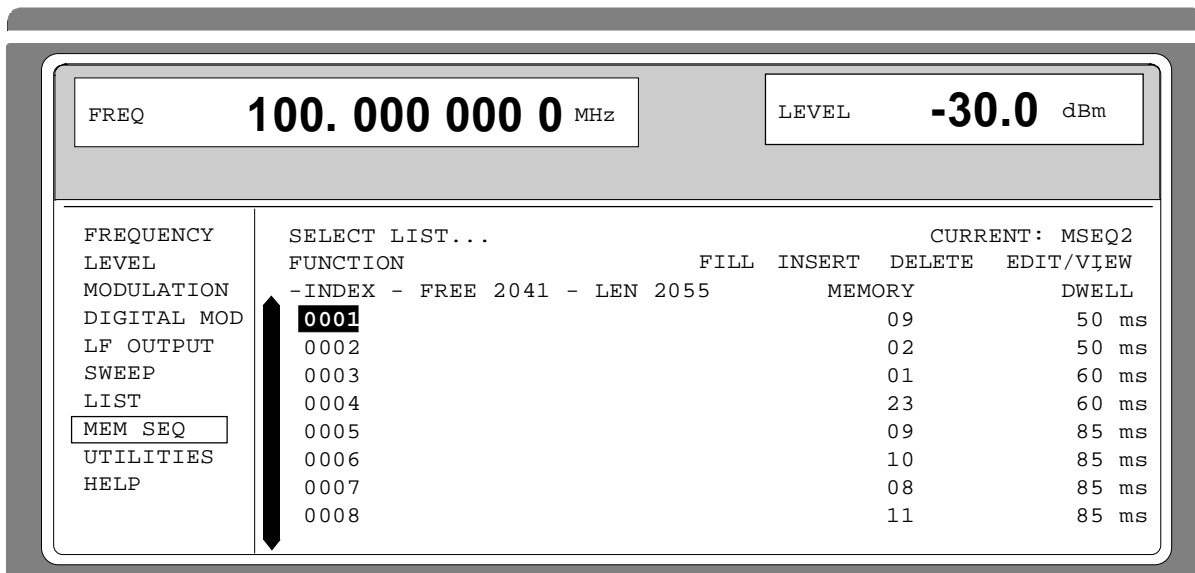

Fig. 2-10 Edit function EDIT/VIEW

**INDEX** Position in the list

**FREE** Space available. FREE 2041 means that space for 2041 parameter elements is available in the list memory in total.

**LEN** Occupied space. LEN 2055 means that the current list occupies 2055 elements in the list memory.

**MEMORY DWELL** Identification of the column below. The number of parameter columns is different for the various list editors. The list editor for digital modulation data possess three parameter columns (DATA, BURST and LEVEL ATTENUATION).

- Select parameters
- Mark the index associated to the parameter using the rotary knob or directly enter the value of the index via the numeric keys.
  - Press [SELECT] key.  
Parameter MEMORY is marked. If the second parameter DWELL is to be marked, press the [SELECT] key again.
- Modify parameters
- Vary the value of the parameter selected using the rotary knob or enter the value directly using numeric keys.
- Note:** The binary coder data of the digital modulations which cannot be varied are an exception. Further, all numeric keys except for "0" and "1" are ineffective in these cases.
- Press the [ENTER] key or unit keys.  
The value is included in the data set. The menu cursor marks the value of the next column. In the last column, the menu cursor then marks the next line of column MEMORY.
  - Press the [RETURN] key.  
The menu cursor wraps back to the INDEX column. The EDIT mode is exited by repeatedly pressing the [RETURN] key (cf. Section 2.2.4.4).

### Block function FILL

Using function FILL, a parameter, e.g. MEMORY, is overwritten with constant or linearly increasing/decreasing values within a defined range. The input window is exited by pressing the [RETURN] key without a modification being carried out.

If the filler range exceeds the end of the list, the list is automatically extended.

The list entry, in the example for MEMORY, with index [AT +n] is calculated as follows from the information AT, RANGE, starting value (MEMORY) and WITH INCREMENT:

$$\text{MEMORY[AT+n]} = \text{starting value (MEMORY)} + n \cdot \text{increment} \quad | \quad (0 \leq n \leq \text{RANGE1})$$

Selection: FUNCTION-FILL

FREQ		100.000 000 0 MHz		LEVEL		-30.0 dBm	
FREQUENCY	SELECT LIST...	<b>FILL AT</b>	10	RANGE	1		
LEVEL	FUNCTION	PARAMETER	MEMORY	DWELL			
MODULATION	-INDEX - FREE 2041 - LEN 2055	MEMORY				1	
DIGITAL MOD	0001	WITH INCREMENT				0	
LF OUTPUT	0002						
SWEEP	0003						
LIST	0004						
MEM SEQ	0005						
UTILITIES	0006						
HELP	0007						
	0008						
		EXECUTE					

Fig. 2-11 Block function FILL: Input window

<b>FILL AT</b>	<p>Setting the filling range.</p> <p>AT        Lower limit (index)</p> <p>RANGE    Number of the elements to be inserted</p>
<b>PARAMETER</b>	<p>Selection on which of the parameters the filling function is to have an effect. This menu option is eliminated if the list only includes elements with one parameter.</p>
<b>MEMORY OR DWELL</b>	<p>Input of the starting value for the parameter selected. This option is only displayed if a selection has been made under PARAMETER MEMORY or DWELL.</p>
<b>WITH INCREMENT</b>	<p>Input of the increment between two successive values. If 0 is entered as increment, a filling procedure with constant values is achieved. This option is only displayed if a selection has been made under PARAMETER MEMORY or DWELL.</p> <p><i><b>Note:</b> In the case of some types of lists, e.g. digital modulation data, indicating an increment is eliminated since there are binary data. In these cases line WITH INCREMENT is eliminated.</i></p>
<b>EXECUTE →</b>	<p>Starts the filling sequence. After the function has been executed, the input window is automatically exited. The current index points to the first element after the processed range.</p>
Filling a list	<p>After selection of function FILL, the menu cursor marks FILL AT.</p> <ul style="list-style-type: none"> <li>➤ Press the [SELECT] key. The menu cursor marks the value at AT.</li> <li>➤ Vary index value using the rotary knob or enter using the numeric keys and the [ENTER] key.</li> <li>➤ Press the [SELECT] key. The menu cursor marks the value at RANGE.</li> <li>➤ Vary value using the rotary knob or enter using the numeric keys and the [ENTER] key.</li> <li>➤ Press the [SELECT] key. The menu cursor marks MEMORY or DWELL in input line PARAMETER.</li> <li>➤ Select MEMORY using the rotary knob (if not yet marked) and press the [SELECT] key. The menu cursor marks the value in input line MEMORY.</li> <li>➤ Vary starting value for column MEMORY using the rotary knob or enter using the numeric keys and the [ENTER] key.</li> <li>➤ Press the [SELECT] key The menu cursor marks the value in input line WITH INCREMENT.</li> <li>➤ Vary the value of the increment desired using the rotary knob or enter using the numeric keys and the [ENTER] key.</li> <li>➤ Press the [RETURN] key.</li> <li>➤ Mark the action EXECUTE →</li> <li>➤ Press the [SELECT] key. The filling sequence is initiated. After the function has been carried out, the input window is automatically exited. The menu cursor marks FUNCTION. The EDIT page shows the end of the range that has been filled right now.</li> </ul>

**Block function INSERT**

Function INSERT inserts the desired number of elements with constant or linearly increasing/decreasing values before the element with the given starting index. All elements which had been stored from the starting index are shifted to the end of the range to be inserted.

Input is effected analogously to filling a list.

By pressing the [RETURN] key the input window is exited without a modification being effected. The menu cursor then marks FUNCTION.

The list entry, in the example for MEMORY, with index [AT +n] is calculated as follows from the information AT, RANGE, starting value (MEMORY) and WITH INCREMENT:

$$\text{MEMORY[AT+n]} = \text{starting value (MEMORY)} + n \cdot \text{Increment} \quad | \quad (0 \leq n \leq \text{RANGE}-1)$$

Selection: FUNCTION INSERT

The screenshot shows a menu interface with the following elements:

- FREQ**: 100.000 000 0 MHz
- LEVEL**: - 30.0 dBm
- FUNCTION LIST**:
 

FREQUENCY	SELECT LIST...	<b>INSERT AT</b>	10 RANGE 2
LEVEL	FUNCTION	MEMORY	1
MODULATION	-INDEX - FREE 2041 - LEN 2055	WITH INCREMENT	0
DIGITAL MOD	0001	DWELL	100ms
LF OUTPUT	0002	WITH INCREMENT	0.0ms
SWEEP	0003		
LIST	0004		
MEM SEQ	0005		
UTILITIES	0006		
HELP	0007		
	0008		
- EXECUTE** ►

Fig. 2-12 Edit function INSERT: Input window

- INSERT AT** Input of the starting index and the number of the elements to be inserted.  
 AT Starting index before which the insert operation is to be effective.  
 RANGE Number of the elements to be inserted
- MEMORY** Input of the starting value for MEMORY.
- DWELL** Input of the starting value for DWELL.
- WITH INCREMENT** Input of the increment between two successive values for MEMORY or DWELL. If 0 is indicated as increment, constant values are achieved to be inserted RANGE times.  
**Note:** In the case of some types of lists, e.g. digital modulation data, indicating an increment is eliminated since there are binary data. In these cases all lines WITH INCREMENT are eliminated.
- EXECUTE** → Starts the inserting sequence. After the function has been executed, the input window is automatically exited. The menu cursor marks FUNCTION. The EDIT page shows the beginning of the range that has moved forward.



## Block function DELETE

Function DELETE deletes the elements of the range indicated. This does not leave a gap in the list but the remaining elements move forward. If the given range exceeds the end of the list, deletion until the end of the list is effected.

Input is analog to filling a list.

By pressing the [RETURN] key, the input window is exited without a modification being carried out. The menu cursor then marks FUNCTION.

Selection: FUNCTION DELETE

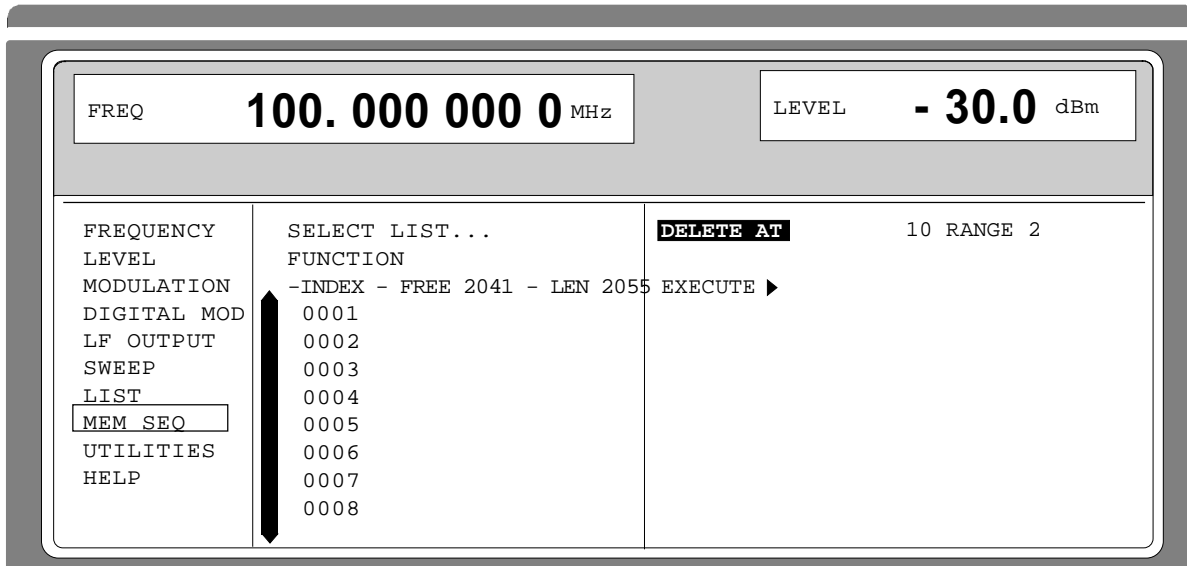

Fig. 2-13 Edit function DELETE: Input window

**DELETE AT**            Input of the block of the list to be deleted  
                           AT            Lower limit (INDEX)  
                           RANGE    Number of elements to be deleted.

**EXECUTE →**            Starts the deletion. After the function has been executed, the input window is automatically exited. The menu cursor marks FUNCTION. The EDIT page shows the beginning of the range that has moved forward.

### 2.2.4.4 Pattern Setting to Operate the List Editor

The user can become familiar with the operation of the list editor by means of the following pattern setting in the MEM SEQ menu. A list has to be generated and filled with values by using the single-value function EDIT/VIEW:

- Memory location number of the first element    20
- Dwell time of the first element                    15s
- Memory location number of the second element 1.

When the setting has been terminated, return to the OPERATION page of the MEM SEQ menu.

At the beginning of the operation sequence, menu MEM SEQ is called. First a list MSEQ0 has to be generated and then activated. The menu cursor marks a parameter of the setting menu on the OPERATION page (c.f. Fig. 2-14).

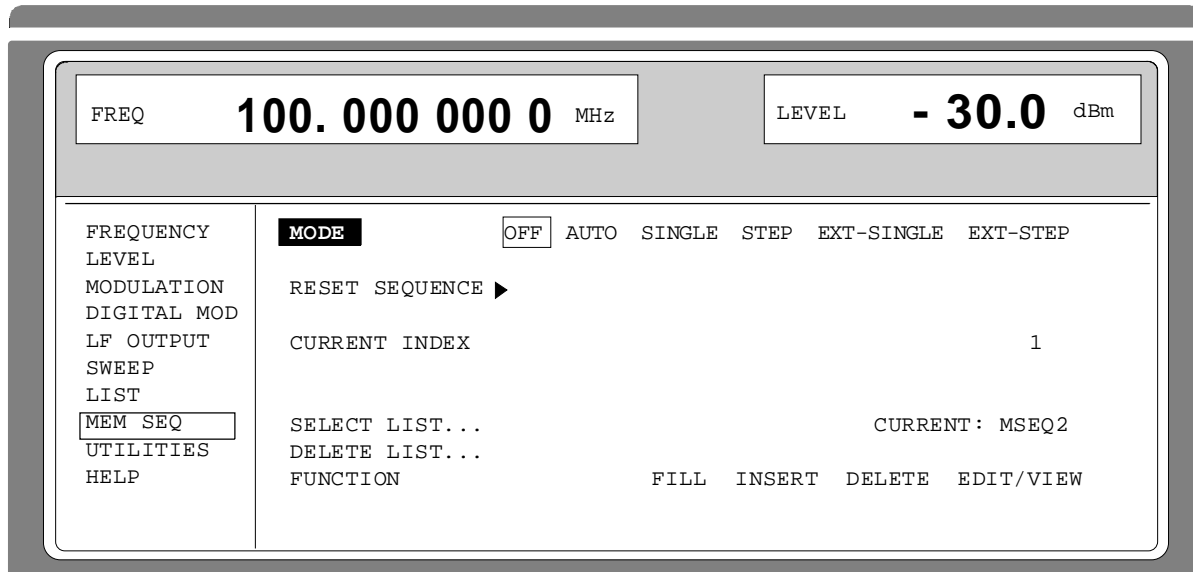

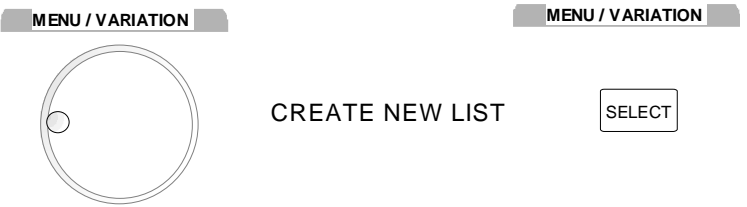

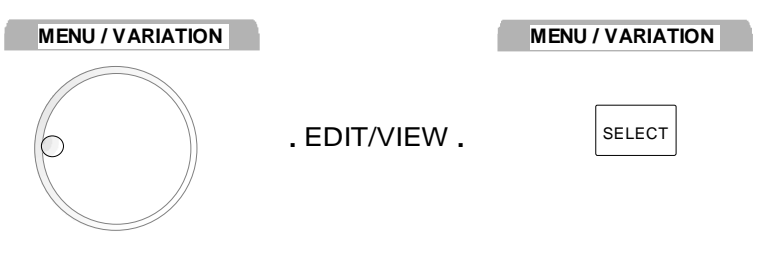

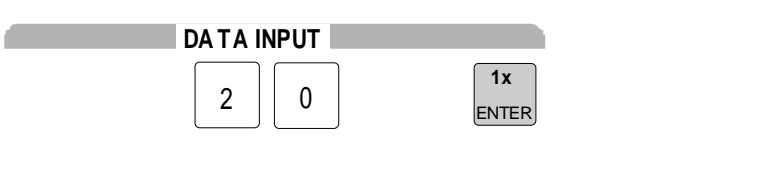
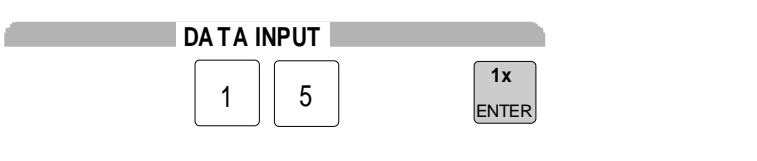
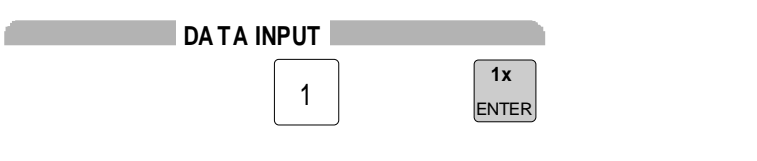





Fig. 2-14 Starting point of the pattern setting

Operating steps	Explanations
 <p>MENU / VARIATION</p> <p>SELECT LIST...</p> <p>SELECT</p>	<p>Select the SELECT LIST menu item.</p>
 <p>MENU / VARIATION</p> <p>CREATE NEW LIST</p> <p>SELECT</p>	<p>A new list MSEQ0 is generated. The menu cursor is reset to SELECT LIST...</p>
 <p>MENU / VARIATION</p> <p>FUNCTION</p> <p>SELECT</p>	<p>Select the FUNCTION menu item.</p>

	<p>Select single-value function EDIT/VIEW.</p> <p>The EDIT page of the MEM SEQ menu is called. The menu cursor marks the index of the first element of list MSEQ0.</p>
	<p>Set the menu cursor to the memory location number value of the first element (c.f. Fig. 2-15,A).</p>
	<p>Enter MEMORY 20.</p> <p>The menu cursor automatically wraps to the DWELL value of the first element (Fig. 2-15,B). The default value is 100 ms.</p>
	<p>Enter DWELL 15 s.</p> <p>The menu cursor automatically wraps to the MEMORY value of the second element.</p>
	<p>Enter MEMORY 1.</p> <p>The menu cursor automatically wraps to the DWELL value of the second element (default value is 100 ms).</p>
	<p>Reset the menu cursor to the index.</p>
	<p>Reset the menu cursor to the FUNCTION menu item of the EDIT page of menu MEM SEQ (c.f. Fig. 2-15,C).</p>
	<p>Reset the menu cursor to the FUNCTION menu item of the OPERATION page of menu MEM SEQ.</p>

**Note:** With the return to the OPERATION page the operation of the list editor is finished. In the list mode (menu LIST), function LEARN ► must be activated subsequently to ensure that the settings are transferred to the hardware.

A

FREQ **100.000 000 0** MHz

LEVEL **- 30.0** dBm

FREQUENCY LEVEL MODULATION DIGITAL MOD LF OUTPUT SWEEP LIST <div style="border: 1px solid black; padding: 1px; display: inline-block;">MEM SEQ</div> UTILITIES HELP	SELECT LIST... FUNCTION -INDEX - FREE 0246 - LEN 0010 0001	CURRENT: MSEQ0 FILL INSERT DELETE EDIT/VIEW MEMORY DWELL
--	---	--

B

FREQ **100.000 000 0** MHz

LEVEL **- 30.0** dBm

FREQUENCY LEVEL MODULATION DIGITAL MOD LF OUTPUT SWEEP LIST <div style="border: 1px solid black; padding: 1px; display: inline-block;">MEM SEQ</div> UTILITIES HELP	SELECT LIST... FUNCTION -INDEX - FREE 0246 - LEN 0010 0001 0002	CURRENT: MSEQ2 FILL INSERT DELETE EDIT/VIEW MEMORY DWELL 20 <b>100 ms</b>
--	---	--

C

FREQ **100.000 000 0** MHz

LEVEL **- 30.0** dBm

FREQUENCY LEVEL MODULATION DIGITAL MOD LF OUTPUT SWEEP LIST <div style="border: 1px solid black; padding: 1px; display: inline-block;">MEM SEQ</div> UTILITIES HELP	SELECT LIST... <div style="border: 1px solid black; padding: 1px; display: inline-block;">FUNCTION</div> -INDEX - FREE 0246 - LEN 0010 0001 0002 0003	CURRENT: MSEQ2 FILL INSERT DELETE EDIT/VIEW MEMORY DWELL 20 15.00 s 07 100 ms
--	--	---

Fig. 2-15, a to c Pattern setting - Edition of a list

## 2.2.5 Save/Recall - Storing/Calling of Instrument Settings

50 complete instrument settings can be stored in memory locations 1 to 50.

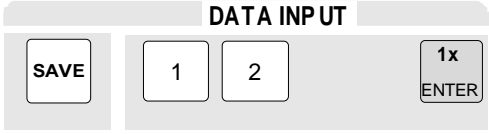
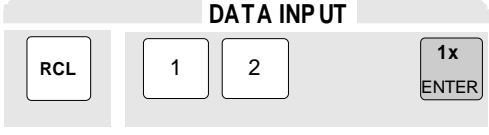
Operating steps	Explanations
 <p>DATA INPUT</p> <p>SAVE 1 2 1x ENTER</p>	Store current instrument setting in memory location 12.
 <p>DATA INPUT</p> <p>RCL 1 2 1x ENTER</p>	Call instrument setting of memory location 12.

The digital display during a save or recall entry is faded in a window.

Memory location 0 has a special function. Here the instrument setting which was current prior to the last memory recall and prior to a preset setting is automatically stored. This permits the resetting of instrument settings which have inadvertently been deleted using Recall 0.

If an instrument setting is stored in which a sweep was switched on, the sweep is started using the recall.

The parameter EXCLUDE FROM RCL in the FREQUENCY and LEVEL-LEVEL menus determines whether the saved RF frequency and RF level are loaded when an instrument setting is loaded, or whether the current settings are maintained.

Store IEC-bus command:            >\*\*SAV 12"

Call IEC-bus command:            >\*\*RCL 12"

**Notes:** – *The contents of lists, as they are used for the LIST mode or for user correction (UCOR), is not saved in the SAVE memory. It is stored under the respective list name and can be called. If instrument settings are called which go back to list data such as level setting using UCOR, the current list contents is used. If this has been altered, it is not identical to the list contents at the point of storing any more.*

– *Memory Sequence is dealt with in Section 2.10.*

- *Model SME03A and units that are equipped with option SM-B50, comprise the "Fast Restore" mode for very fast loading of stored device settings. This mode can be called up only during remote control (see section 3, "Fast Restore Mode".)*

## 2.3 Menu Summary

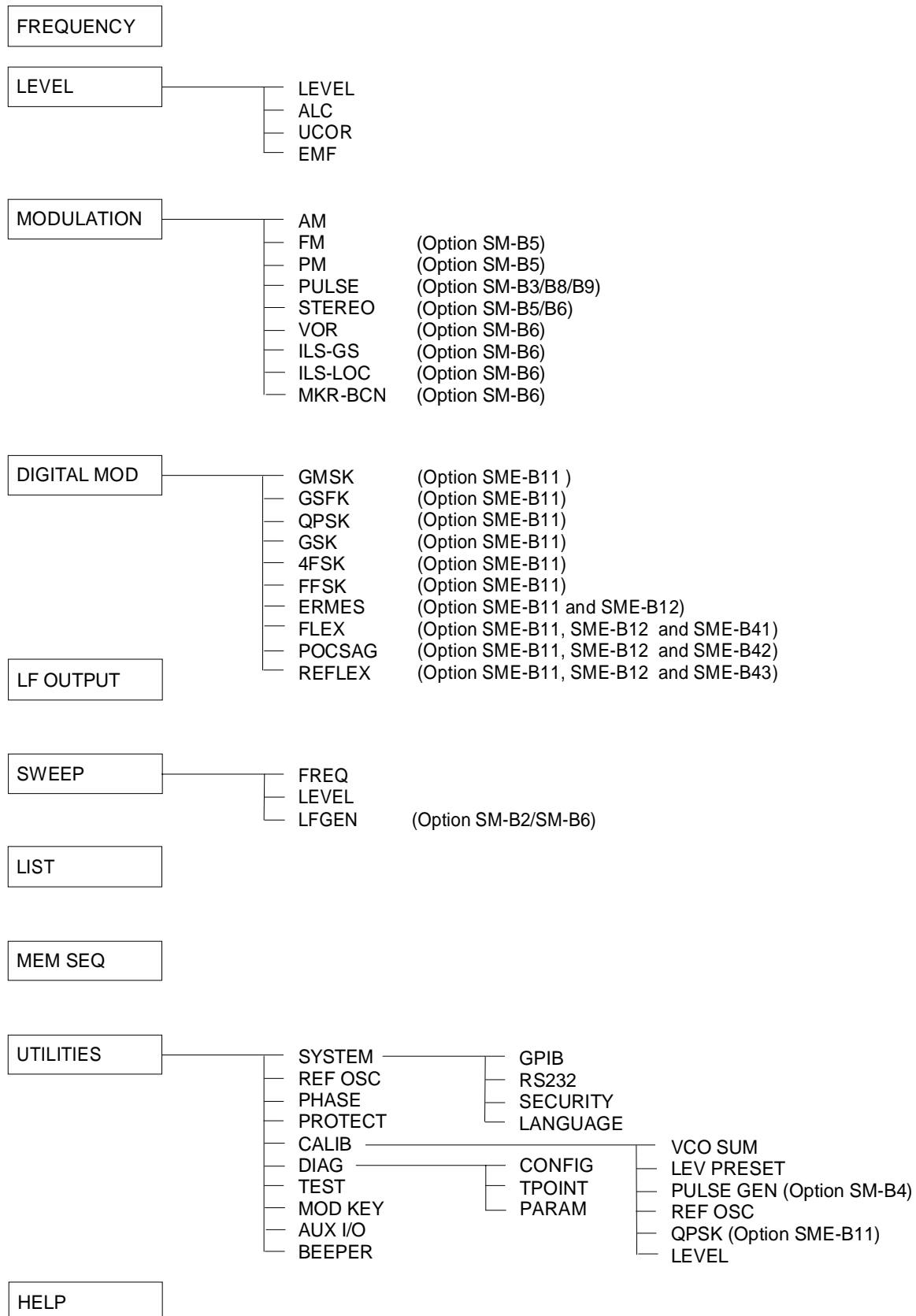

## 2.4 RF Frequency

The frequency of the RF output signal can be set directly using the [FREQ] key (cf. Section 2.2.2.5) or by accessing menu FREQUENCY.

In the FREQUENCY menu, the frequency of the RF output signal is indicated under FREQUENCY.

In the case of frequency settings effected in the FREQUENCY menu, the value entered directly is the frequency of the RF output signal.

The input value of frequency settings opened by means of the [FREQ] key considers the offset in calculation (cf. next Section). This offers the possibility of entering the desired output frequency of possibly series-connected instruments such as mixers in the menu.

<i>Note:</i>	<i>Further settings:</i>	<i>Frequency sweep</i>	<i>Menu SWEEP</i>
		<i>LF frequency</i>	<i>Menu MODULATION</i>
			<i>Menu LF-OUTPUT</i>
		<i>int./ext. reference frequency</i>	<i>Menu UTILITIES-REF OSC</i>
		<i>Phase of the output signal</i>	<i>Menu UTILITIES-PHASE</i>

Menu selection: FREQUENCY

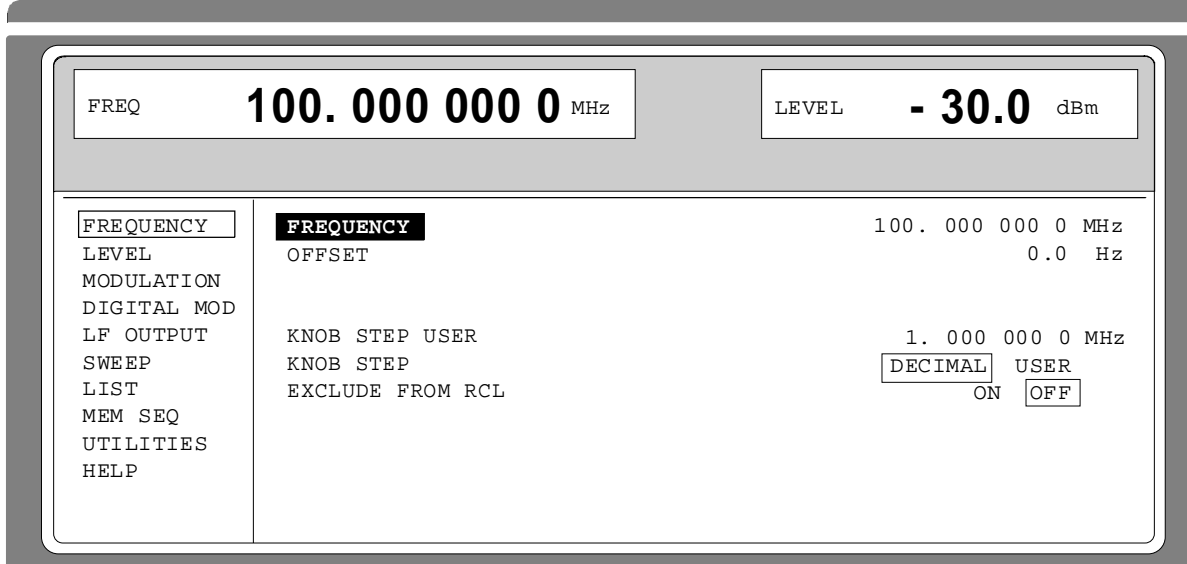

Fig. 2-16 Menu FREQUENCY (preset setting)

**FREQUENCY** Input value of the RF frequency considering the OFFSET input value. The frequency of the RF output signal is determined by input values FREQUENCY and OFFSET (cf. Section 2.4.1 Frequency Offset).

IEC-bus command `SOUR:FREQ 100E6`

**OFFSET** Input value of the frequency offset, e.g., of a series-connected mixer (cf. Section 2.4.1, Frequency Offset).

IEC-bus command `SOUR:FREQ:OFFS 0`

**KNOB STEP USER** Input value of the step width for frequency variation using the rotary knob. The RF frequency is varied in the step width entered if KNOB STEP is set to USER.

IEC-bus command `SOUR:FREQ:STEP 1MHz`

<b>KNOB STEP</b>	DECIMAL:	Variation step width corresponding to the position of the digit cursor.
	USER:	"User Defined", variation step width as entered under KNOB STEP USER .
<b>EXCLUDE FROM RCL</b>	OFF	The saved frequency is loaded as well when instrument settings are loaded with the [RCL] key or with a memory sequence. IEC-bus command            SOUR:FREQ:RCL INCL
	ON	The RF frequency is not loaded when instrument settings are loaded, the current frequency settings are maintained. IEC-bus command            SOUR:FREQ:RCL EXCL

**2.4.1 Frequency Offset**

The SME offers the possibility of entering an offset (OFFSET) of possibly series-connected instruments in the FREQUENCY menu. The indication/input value of FREQ in the header field considers this input and represents the frequency value of the RF signal at the output of these instruments (cf. Fig. 2-17).

The entry values FREQUENCY and OFFSET in the menu FREQUENCY or FREQ in the header line are related to the RF output frequency as follows :

$$\text{FREQ} - \text{OFFSET} = \text{output frequency (= FREQUENCY)}.$$

An offset entry causes no modification of the RF output frequency but only a modification of the display value in the FREQ field in the header line, ie FREQ in the header line indicates the offset-associated frequency and FREQUENCY in the menu FREQUENCY the RF output frequency. The status line indicates FREQ-OFFST.

The offset setting also remains effective with the frequency sweep.

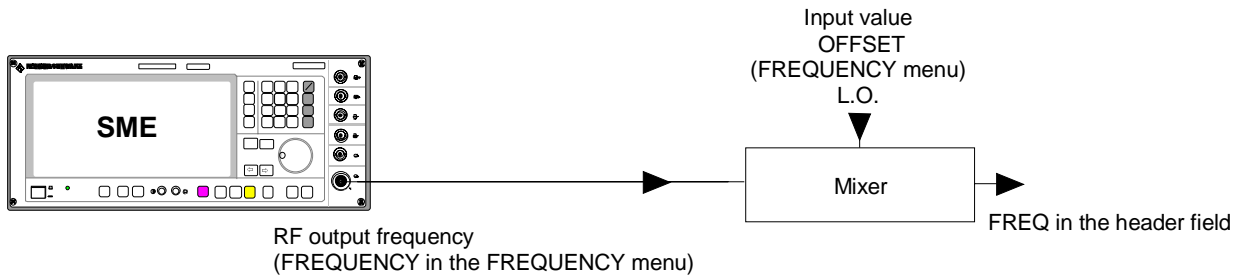

Fig. 2-17 Example of a circuit with frequency offset



## 2.5 RF Level

The RF output level can be set directly using the [LEVEL] key (cf. Section 2.2.2.5) or by accessing the LEVEL menu.

In the LEVEL-LEVEL menu, the set RF output level is indicated under AMPLITUDE. A two-line level display appears for digital modulation or digital standard. The upper line indicates the average power (LEVEL), the lower line the peak envelope power (PEP) of the modulated RF output signal.

The input value of level settings effected in the LEVEL-LEVEL menu directly corresponds to the RF output level.

The input value of the level settings opened using the [LEVEL] key mathematically considers the offset of an attenuation/amplification element which is possibly series-connected (cf. Section 2.5.1). This offers the possibility of entering the desired level at the output of series-connected instruments, the SMIQ then alters the RF output level correspondingly. The offset can also be entered in the LEVEL-LEVEL menu.

dBm, dB $\mu$ V, mV and  $\mu$ V can be used as level units. The 4 unit keys are directly labeled with these units. In order to change to another level unit, simply press the desired unit key.

- Notes:**
- The message *ERROR* is displayed in the status line if the level set in the overrange is not reached.
  - For digital modulation or digital standard, a *WARNING* message appears in the status line if the set LEVEL or the displayed PEP are overranged. If the set level cannot be generated as an overrange value, *ERROR* will be displayed.
  - Further settings: Level sweep menu *SWEEP*

Menu selection: LEVEL – LEVEL

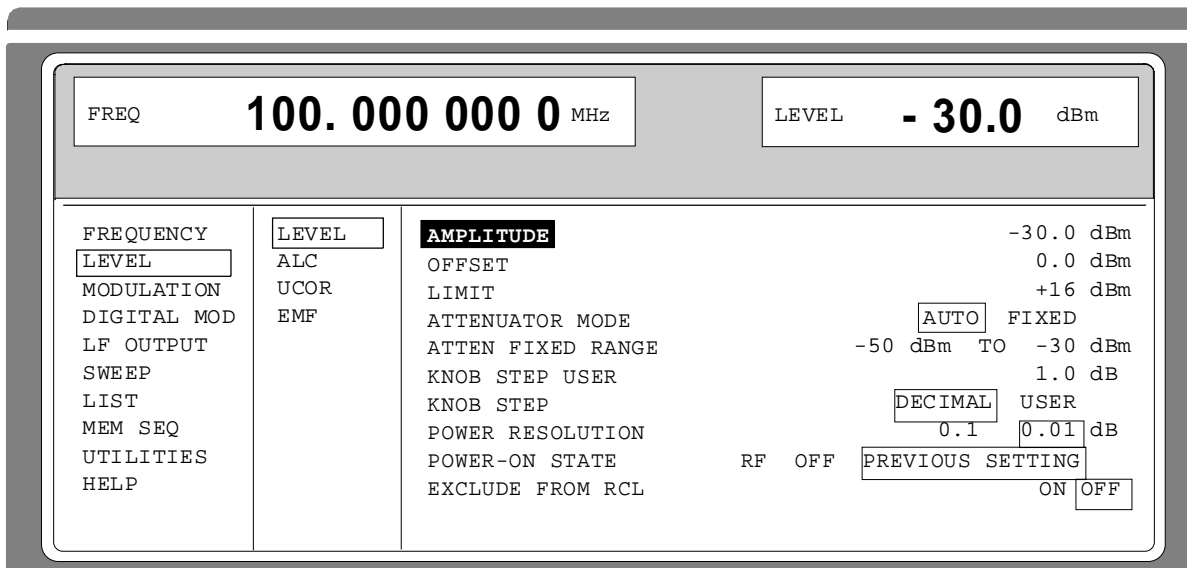

Fig. 2-18 Menu LEVEL (preset setting) POWER RESOLUTION is set to 0.01 dB

**AMPLITUDE** Input value of the RF level at the RF output connector.  
IEC/IEEE-bus command SOUR:POW 30

**OFFSET** Input value of the level offset of the RF output level compared to the input value of the RF level indicated in the LEVEL header field. Input in dB (cf. Section 2.5.1, Level Offset). The status line indicates LEV-OFFST.  
IEC/IEEE-bus command SOUR:POW:OFFS 0

<b>LIMIT</b>	Input value of level limitation. This value indicates the upper limit of the level at the RF output connector. If a level above this limit is attempted to be set, a warning is displayed in the status line. IEC-bus command                    SOUR:POW:LIM 16 dBm
<b>ATTENUATOR MODE</b>	<p><b>AUTO</b>     Normal operation. The attenuator switching mechanically switches in steps of 5 dB, the switching points being fixed. IEC-bus command                    :OUTP:AMOD AUTO</p> <p><b>FIXED</b>    Level settings are effected without switching the attenuator (cf. Section 2.5.2, Interrupt-free Level Setting). IEC-bus command                    :OUTP:AMOD FIX</p>
<b>ATTEN FIXED RANGE</b>	Indication of the level range in which the level is set without interruption in the "ATTENUATOR MODE FIXED" operating mode.
<b>KNOB STEP USER</b>	Input value of the step width for level variation using the rotary knob. The RF level is varied in the step width entered if KNOB STEP is set to USER. IEC-bus command                    SOUR:POW:STEP 1
<b>KNOB STEP</b>	<p><b>DECIMAL</b> Variation step width according to the position of the digit cursor.</p> <p><b>USER</b>     User Defined, variation step width as entered under KNOB STEP USER.</p>
<b>POWER RESOLUTION</b>	Selection of resolution of LEVEL display. For level range -99.9 dBm to +16 dBm the resolution for the level display can be set to 0.1 dB or 0.01 dB.
<b>POWER-ON STATE</b>	<p>Selection of the state the RF output is to assume after power-on of the unit</p> <p><b>RF OFF</b>                                Output is switched off</p> <p><b>PREVIOUS SETTING</b>                Same state as before switch-off</p> <p>IEC-bus command                    :OUTP:PON ON</p>
<b>EXCLUDE FROM RCL</b>	<p><b>OFF</b>     The saved RF level is loaded as well when instrument settings are loaded with the [RCL] key or with a memory sequence. IEC-bus command                    SOUR:POW:RCL INCL</p> <p><b>ON</b>      The RF level is not loaded when instrument settings are loaded, the current level settings are maintained. IEC-bus command                    SOUR:POW:RCL EXCL</p>

### 2.5.1 Level Offset

The SME offers the possibility of entering the offset (OFFSET) of a possibly series-connected attenuator/amplification element in the LEVEL-LEVEL menu. The indication/input value in the LEVEL header field considers this input (see below) and represents the level value of the signal at the output of the series-connected instrument (cf. Fig. 2-19).

The entry values AMPLITUDE and OFFSET in the menu LEVEL or LEVEL in the header line are related to the RF output level as follows:

$$\text{LEVEL} - \text{OFFSET} = \text{output level} (= \text{AMPLITUDE})$$

An offset entry causes no modification of the RF output frequency but only a modification of the display value in the LEVEL field in the header line, ie LEVEL in the header line indicates the offset-associated level and AMPLITUDE in the menu LEVEL the RF output level. The status line indicates LEV-OFFST. The offset is to be entered in dB.

The offset setting also remains effective in the ATTENUATOR MODE FIXED operating mode and with level sweep.

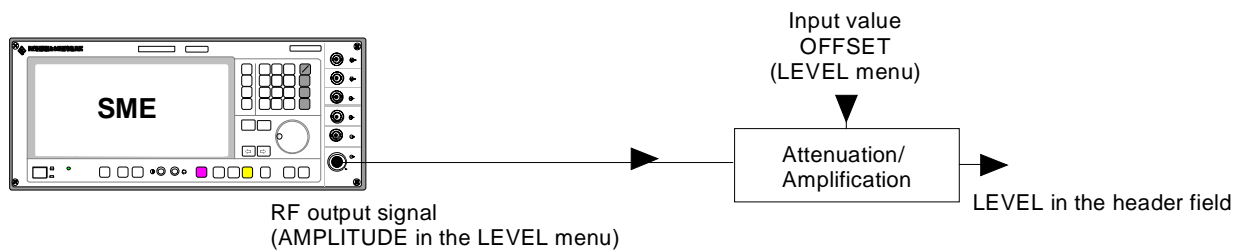

Fig. 2-19 Example of a circuit with level offset

### 2.5.2 Interrupt-free Level Setting

In the ATTENUATOR MODE FIXED operating mode, level settings are carried out without interruption. An electronic attenuation setting is used instead of the interrupting attenuator.

If the normal variation range of 23 dB is violated, the level under/overrange warning is displayed. In these ranges, level accuracy and spectral purity are no longer guaranteed.

### 2.5.3 Switching On/Off Internal Level Control

Menu LEVEL-ALC offers access to settings for level control.

Level control can be deactivated and various bandwidths of the level control can be switched on.

Switching off level control (ALC STATE OFF) switches over the internal level control into a sample-and-hold operation. In this operating mode, level control is automatically switched on for a short period of time after every level and frequency setting, and then the level control is held at the value achieved. Switching off the level control is used with multi-transmitter measurements to achieve a larger intermodulation ratio.

Bandwidth setting influences the AM noise of the output signal. The bandwidth of the level control has the same effect as a filter of the same bandwidth.

Menu selection: LEVEL - ALC

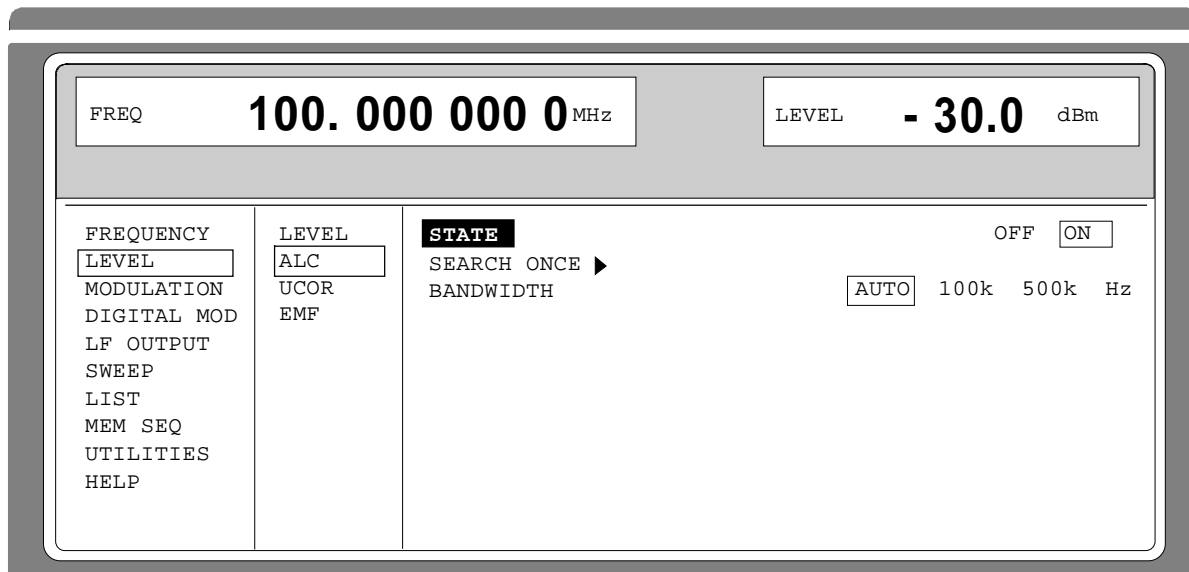

Fig. 2-20 Menu LEVEL - ALC (preset setting)

<b>STATE</b>	ON	Normal state. Internal level control is permanently switched on. IEC-bus command SOUR:POW:ALC ON
	OFF	Internal level control is deactivated. In this state no AM and no digital modulation with AM content is possible. IEC-bus command SOUR:POW:ALC OFF
<b>SEARCH ONCE →</b>		Manual short-time switching on of the level control for level calibration in the ALC STATE OFF operating mode. IEC-bus command SOUR:POW:ALC ON;ALC OFF

### 2.5.4 Internal Level Control - Bandwidth Selection

- BANDWIDTH** Selection of the bandwidth of the level control.
- AUTO The bandwidth is automatically adapted to the operating conditions.  
IEC-bus command SOUR:POW:ALC:BAND:AUTO ON
  - 100 kHz Bandwidth narrow. This setting improves AM noise with carrier offset >100 kHz. However, the AM bandwidth is restricted..  
IEC-bus command SOUR:POW:ALC:BAND 100kHz ;BAND:AUTO OFF
  - 500 kHz Full bandwidth  
IEC-bus command SOUR:POW:ALC:BAND 500kHz ;BAND:AUTO OFF

### 2.5.5 User Correction (UCOR)

Function "User Correction" can be used to create and activate lists in which arbitrary RF frequencies are assigned level correction values.

Up to 10 lists with a total of 160 correction values can be compiled. For frequencies which are not included in the list the level correction is determined by means of interpolation of the nearest correction values.

When user correction is switched on, the LEVEL indication is completed by the indication UCOR (User Correction) in the header field of the display. The RF output level is the sum of both values.

$$\text{LEVEL} + \text{UCOR} = \text{output level}$$

If the offset setting is used at the same time, the LEVEL indication value is the difference of the input values AMPLITUDE and OFFSET of the menu LEVEL.

$$\text{AMPLITUDE} - \text{OFFSET} = \text{LEVEL}$$

The user correction is effective in all operating modes if switched on.

Menu selection: LEVEL - UCOR

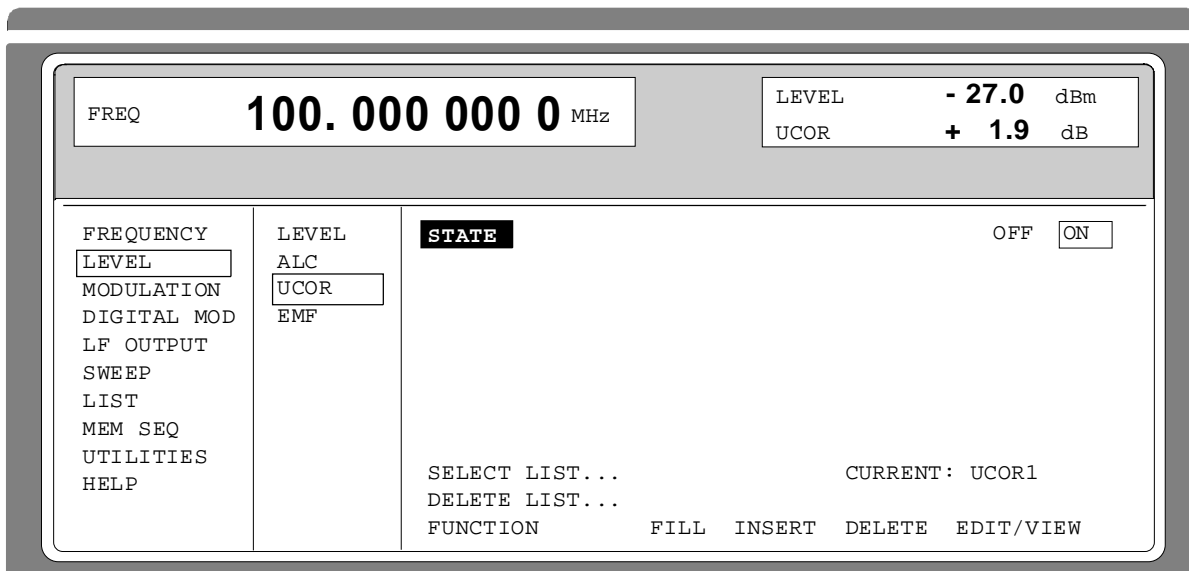

Fig. 2-21 Menu LEVEL - UCOR - OPERATION side

**STATE** Switching on/off user correction.  
IEC-bus command SOUR:CORR ON

**SELECT LIST...** Selection of a list or generation of a new list(cf. Section 2.2.4, List Editor)  
IEC-bus command SOUR:CORR:CSET "UCOR1"

**DELETE LIST...** Deletion of a list (cf. Section 2.2.4, List Editor)  
IEC-bus command SOUR:CORR:CSET:DEL "UCOR2"

**FUNCTION** Selection of the editing mode to process the selected list  
IEC-bus commands SOUR:CORR:CSET:DATA:FREQ 100 MHz, 102 MHz, ...  
SOUR:CORR:CSET:DATA:POW 1dB, 0.8dB, ...

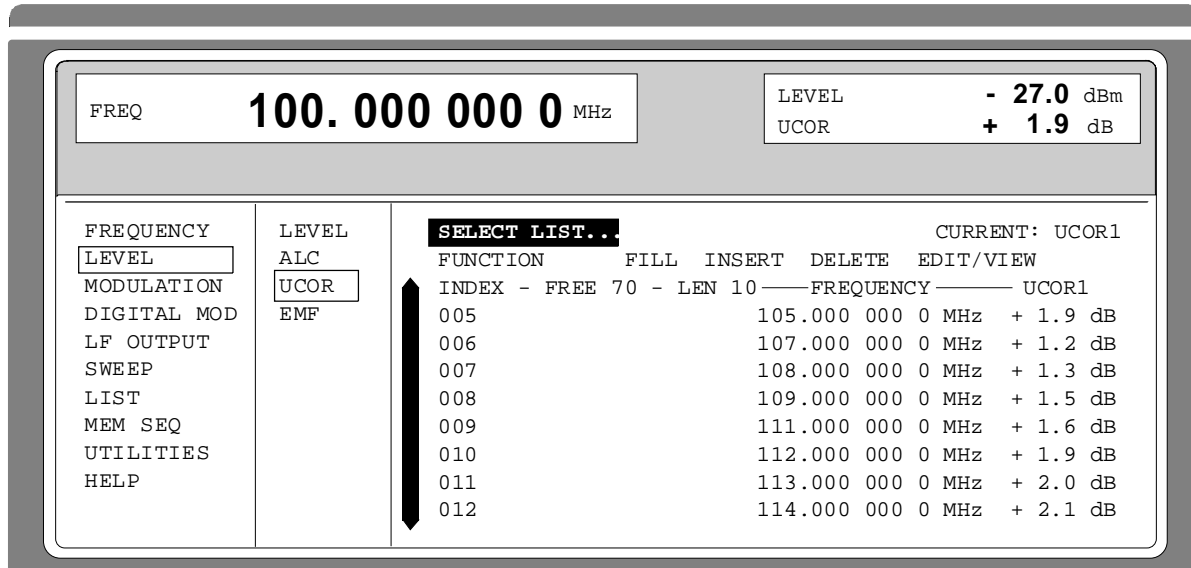

Fig. 2-22 Menu UCOR - LEVEL-EDIT side

## 2.5.6 EMF

The signal level can also be set and indicated as the voltage of EMF (open-circuit voltage).

EMF is displayed in the header field of the display after the unit of the level indication.

Menu selection: LEVEL - EMF

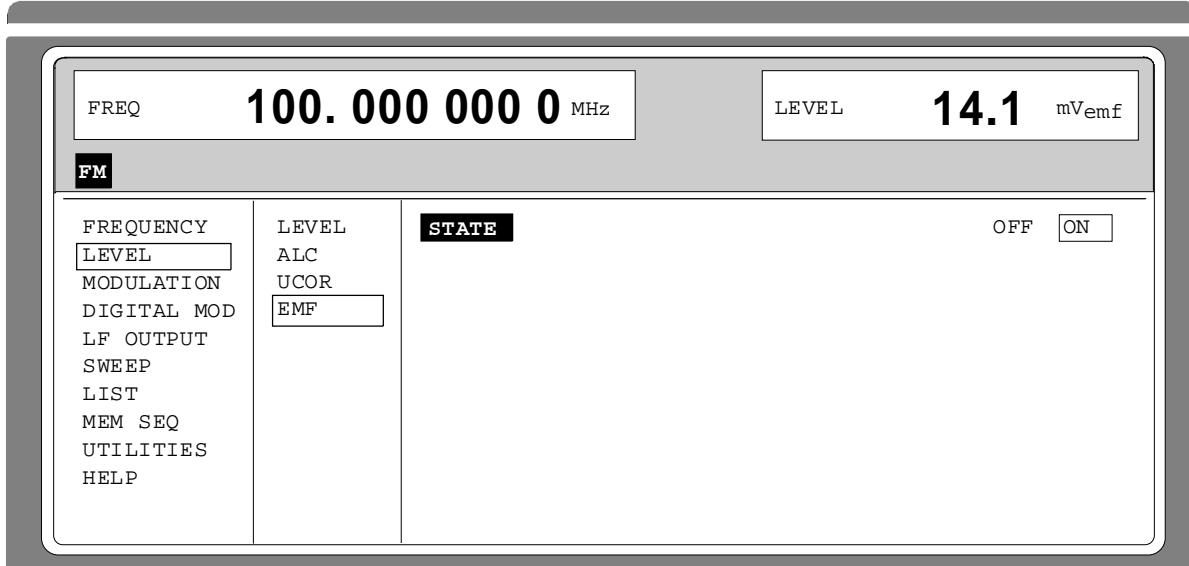

Fig. 2-23 Menu LEVEL-EMF

<b>STATE</b>	ON	Voltage value of the level is the voltage of EMF.
	OFF	Voltage value of the level is voltage at 50 $\Omega$ (preset setting).

## 2.5.7 [RF ON / OFF]-Key

The RF output signal is switched on and off again using the [RF ON / OFF] key. This does not influence the current menu. When the output signal is switched off, the message "RF OFF" is displayed in the LEVEL indication of the header field. If RF OFF is displayed, the 50- $\Omega$  source resistance is maintained.

IEC-bus command :OUTP OFF

## 2.5.8 Reset Overload Protection (only SME02 and SME03)

SME02 and SME03 are protected against overload by an external signal which is fed into the RF output. If an external signal is too high, the overload protection responds. This state is indicated by means of the message "RF OFF" in the LEVEL indication in the header field and the message "OVERLOAD" in the status line.

➤ Reset the overload protection by pressing the [RF ON / OFF] key.

IEC-bus command :OUTP:PROT:CLE

SMT06 is not protected against overvoltage, the IEC/IEEE-bus command being ignored.

## 2.6 Modulation

The SME offers the following modulations:

- Amplitude modulation (AM)
- Frequency modulation (FM) \*
- Phase modulation (PM) \*
- Pulse modulation (PULSE) \*
- FM-stereo modulation (STEREO) \*\*
- VOR/ILS modulation (VOR, ILS-GS, ILS-LOC, MKR BCN) \*

and the digital modulations:

- GMSK, GFSK, QPSK, FSK, FFSK, 4FSK and \*
- Radiocommunication services ERMES, FLEX, REFLEX and POCSAG. \*

Internal or external modulation sources can be used for all modulations.

### 2.6.1 Modulation Sources

#### Internal Modulation Sources

Internal modulation generators LF GEN1 and LF GEN2 are available for AM, FM and PM depending on the equipment. For a more detailed description, cf. Section 2.6.2.1, LF Generator.

For internal pulse modulation, the instrument can be equipped with a pulse generator (option SM-B4). For a more detailed description, cf. Section 2.6.2.5.1, Pulse Generator.

A PRBS generator with selectable sequence lengths and a data generator are available for the digital modulations (cf. Section 2.6.3, Digital Modulation).

#### External Modulation Sources

The appropriate input sockets to the different modulations in the case of external supply can be taken from table 2-1. DM (digital modulation) stands for GMSK, GFSK, QPSK, FSK, FFSK and 4FSK. External AM, FM and PM can be AC or DC-coupled.

Table 2-1 Input sockets for the different types of modulation

Modulation	Inputs					
	EXT1	EXT2	PULSE	DATA	CLOCK	BURST
AM	X					
FM1	X	X				
FM2	X	X				
PM1	X	X				
PM2	X	X				
PULSE			X			
DM				X	X	X

\* Only with option



The external modulation signal must show a voltage of  $V_s = 1 \text{ V}$  ( $V_{\text{eff}} = 0.707 \text{ V}$ ) in order to maintain the modulation depth or deviation indicated. Deviations of more than  $\pm 3 \%$  are signaled in the status line by means of the following messages (cf. table 2-2).

Table 2-2 Status messages in the case of a deviation from the rated value at the external modulation input

Message	Deviation
EXT1-HIGH	Voltage at EXT1 too high
EXT1-LOW	Voltage at EXT1 too low
EXT2-HIGH	Voltage at EXT2 too high
EXT2-LOW	Voltage at EXT2 too low
EXT-HI/HI	Voltage at EXT1 and EXT2 too high
EXT-LO/LO	Voltage at EXT1 and EXT2 too low
EXT-HI/LO	Voltage at EXT1 too high and EXT2 too low
EXT-LO/HI	Voltage at EXT1 too low and EXT2 too high

### 2.6.1.1 Simultaneous Modulation

Basically, every combination of AM, FM, pulse modulation and a digital modulation (GMSK, GFSK, QPSK, FSK, FFSK or 4FSK) is possible. Instead of FM, phase modulation (PM) can be switched on as well. There are only restrictions for modulations of the same kind and for the multiple use of the 2nd LF generator (cf. table 2-3).

Two-tone AM is possible by simultaneously switching on the external and internal source.

Two-tone FM or two-tone PM is possible by simultaneously switching on FM1 and FM2 or PM1 and PM2. For FM1 and FM2 (PM1 and PM2) separate deviations can be set and separate sources switched on.

**Note:** *With two-tone modulation please observe that the set deviation or modulation depth is valid for one signal and the sum deviation or sum modulation depth is determined by adding both signals. This results in overmodulation if the maximal value for deviation or modulation depth is exceeded.*

### 2.6.1.2 Alternate Switching Off of Modulations

Due to the multiple use of some functional modules in the instrument some modulations cannot be set at the same time (cf. table 2-3). In the case of manual control, incompatible modulations deactivate one another, a short-time warning is displayed in the status line.

**Note:** *The IEC-bus control according to SCPI forbids the mutual influence of types of modulation on one another. In the case of remote control, an error message is outputted when the attempt is made to switch on incompatible types of modulation (cf. annex B).*

Table 2-3 Modulations which cannot be operated simultaneously

	AM INT1	AM INT2	AM EXT1	FM INT1	FM1 EXT1,2	FM2 INT2	FM2 EXT1,2	PM1 INT1	PM1 EXT1,2	PM2 INT2	PM2 EXT1,2	Stereo	VOR	ILS	MCR BCN
AM INT1													X	X	X
AM INT2												X	X	X	X
AM EXT1													<input checked="" type="checkbox"/>	<input checked="" type="checkbox"/>	X
FM1 INT1					<input type="checkbox"/>			X	X	X	X				
FM1 EXT1,2				<input type="checkbox"/>				X	X	X	X				
FM2 INT2							<input type="checkbox"/>	X	X	X	X	X	X	X	X
FM2 EXT1,2						<input type="checkbox"/>		X	X	X	X	X			
PM1 INT1				X	X	X	X		<input type="checkbox"/>			X			
PM1 EXT1,2				X	X	X	X	<input type="checkbox"/>				X			
PM2 INT2				X	X	X	X				<input type="checkbox"/>	X	X	X	X
PM2 EXT1,2				X	X	X	X			<input type="checkbox"/>		X			
Stereo		X				X	X	X	X	X	X		X	X	X
VOR	X	X	<input checked="" type="checkbox"/>			X				X		X		X	X
ILS	X	X	<input checked="" type="checkbox"/>			X				X		X	X		X
MKR-BCN	X	X	X			X				X		X	X	X	

- X Mutual switching off in the case of manual control
- in the VOR-(ILS..) menu AM EXT can be added as an own parameter
- Switching off by means of 1-out-of-n selection

### 2.6.1.3 [MOD ON/OFF] Key

The modulations can directly be switched on/off using the key [MOD ON/OFF] or by accessing the MODULATION menu. When switching on using the [MOD ON/OFF] key, the modulation sources which are set in the modulation menus are used.

The [MOD ON/OFF] key can either be effective for all modulations or for a selected modulation. The selection for which modulation the [MOD ON/OFF] key is effective is made in the UTILITIES-MOD KEY menu (cf. Section " Assigning Modulation to [MOD ON/OFF] Key").

When selecting a certain type of modulation, each pressing the [MOD ON/OFF] key switches on or off the modulation selected.

In the case of selection "all modulations", the [MOD ON/OFF] key has the following effect:

- At least one modulation is active:  
Pressing the [MOD ON/OFF] key switches off all active modulations. Which modulations were active is stored.
- No modulation is active:  
Pressing the [MOD ON/OFF] key switches on the modulations which were last switched off using the [MOD ON/OFF] key.

## 2.6.2 Analog Modulation

### 2.6.2.1 LF-Generator

The SME is equipped with a fixed-frequency generator as internal modulation source as a standard. The generator supplies sinusoidal signals of the frequencies of 0.4, 1, 3 and 15 kHz.

In addition to the standard equipment, the SME can be equipped with the following optional LF modulation sources:

- LF-generator, option SM-B2
- Multifunction generator, option SM-B6

It is possible to fit two optional modulation sources unless option SM-B3, pulse modulator, is fitted. If two options are fitted, the access to the internal standard generator is eliminated. The different possibilities of modulation generator fitting are visible from table 2-4:

Table 2-4 Modulation generators as component parts

LF-Generator 1	LF-Generator 2
Standard generator	---
Standard generator	Option SM-B2, LF-generator
Standard generator	Option SM-B6, multifunction generator
Option SM-B2, LF-generator	Option SM-B2, LF-generator
Option SM-B2, LF-generator	Option SM-B6, multifunction generator

The selection of the waveform and frequency of the internal modulation signals can be made in one of the modulation menus ( AM, FM, PM) as well as in the LF-output menu.

- Notes:**
- *In conformance to the possibilities of the modulation generator options fitted, there are differences in the modulation menus for AM, FM and PM.*
  - *The following modulations cannot be set simultaneously and deactivate one another: LFGEN SHAPE NOI and LF sweep.*

2.6.2.2 Amplitude Modulation

Menu MODULATION-AM offers access to settings for amplitude modulation.

- Notes:**
- In the level range from 7 to 13 dBm, the specified AM data are only guaranteed for a linearly decreasing modulation depth with a rising level. When a modulation depth is set that is too high, "WARNING" is displayed in the status line or the message "WARN -221 Settings conflict; modulation forces peak level into overrange" is displayed after pressing the ERROR key.
  - Modulations AM, VOR, ILS and MKR BCN deactivate one another. AM SOURCE INT = LFGEN2 and STEREO deactivate one another as well.

Menu selection: MODULATION- AM

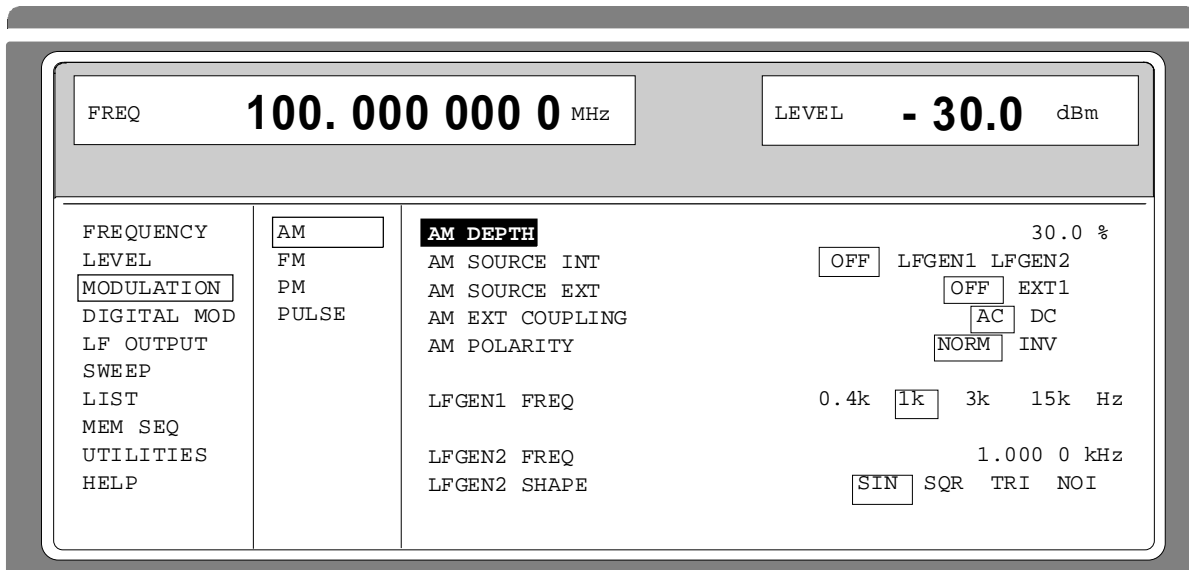

Fig. 2-24 Menu MODULATION-AM (preset setting), fitted with option SM-B2, LF-generator (LFGEN2)

<b>AM DEPTH</b>	Input value of the modulation depth.. IEC-bus command            SOUR:AM 30PCT
<b>AM SOURCE INT</b>	Selection of the internal source. IEC-bus command            SOUR:AM:SOUR INT1; STAT ON
<b>AM SOURCE EXT</b>	Selection of the external source. IEC-bus command            SOUR:AM:SOUR EXT; STAT ON
<b>AM EXT COUPLING</b>	Selection of the kind of coupling AC or DC with external supply (input EXT1). IEC-bus command            SOUR:AM:EXT:COUP AC

<b>AM POLARITY</b>	Selection of the polarity of amplitude modulation. NORM      A positive modulation voltage generates a higher output level. INV        The AM polarity is inverted. IEC-bus command            SOUR:AM:POL NORM
<b>LFGEN1 FREQ</b>	Selection of the frequency of the 1st LF generator. IEC-bus command            SOUR:AM:INT1:FREQ 1kHz
<b>LFGEN2 FREQ</b>	Input value of the frequency of the 2nd LF generator. IEC-bus command            SOUR:AM:INT2:FREQ 1kHz
<b>LFGEN2 SHAPE</b>	Selection of the waveform of the 2nd LF generator. IEC-bus command            :SOUR2:FUNC SIN

### 2.6.2.3 Frequency Modulation

Menu MODULATION-FM offers access to settings for frequency modulation.

**Note:** The following modulations cannot be set simultaneously and deactivate one another:  
 FM and PM; FM2 and STEREO; FM2 SOURCE = LFGEN2 and VOR, ILS, MKR BCN

Menu selection: MODULATION-FM

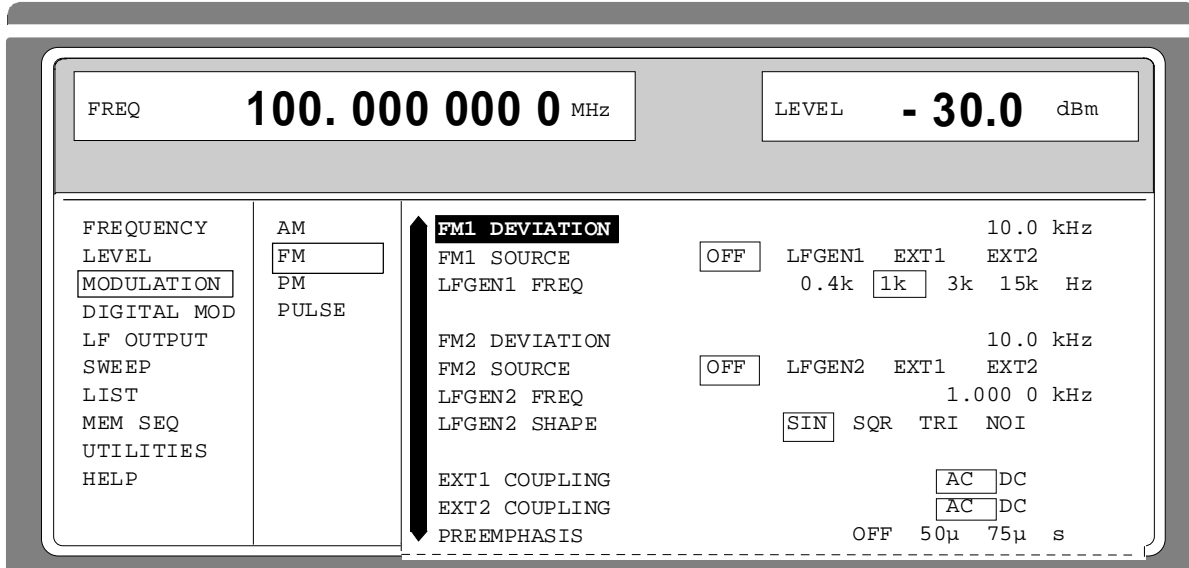

Fig. 2-25 Menu MODULATION-FM (preset setting), fitted with option SM-B2, LF-generator (LFGEN2) and option SM-B5, FM/PM-modulator

<b>FM1 DEVIATION</b>	Input value of the deviation for FM1. IEC-bus command      SOUR:FM1 10kHz
<b>FM1 SOURCE</b>	Switching on and off FM1 and selection of the modulation source. IEC-bus command      SOUR:FM1:SOUR INT; STAT ON
<b>LFGEN1 FREQ</b>	Selection of the frequency of the 1st LF generator. EC-bus short command      SOUR:FM1:INT:FREQ 1kHz
<b>FM2 DEVIATION</b>	Input value of the deviation for FM2. EC-bus short command      SOUR:FM2 10kHz
<b>FM2 SOURCE</b>	Switching on and off FM2 and selection of the modulation source. EC-bus short command      SOUR:FM2:STAT OFF
<b>LFGEN2 FREQ</b>	Input value of the LFGEN2 frequency. EC-bus short command      SOUR:FM2:INT:FREQ 1kHz
<b>LFGEN2 SHAPE</b>	Selection of the waveform of the 2nd LF generator. EC-bus short command      SOUR:SOUR2:FUNC SIN
<b>EXT1 COUPLING</b>	Selection of the type of coupling AC or DC for the external input EXT1. IEC-bus command      SOUR:FM1:EXT1:COUP AC

<b>EXT2 COUPLING</b>	Selection of the type of coupling AC or DC for the external input EXT2. IEC-bus command	SOUR:FM1:EXT2:COUP AC
<b>PREEMPHASIS</b>	Selection of the preemphasis IEC-bus command	SOUR:FM1:PRE 50us

### 2.6.2.3.1 FM Deviation Limits

The maximal deviation depends on the RF frequency set (cf. Fig. 2-26). It is possible to enter a deviation that is too high for a certain RF frequency or to vary the RF frequency to a range in which the deviation can no longer be set. In this case the maximally possible deviation is set and an error message is displayed.

In the RF range 93.75 MHz to 130 MHz a different synthesis range is selected depending on the deviation set. If the deviation is smaller than 62,5 kHz, the synthesizer is in the division range with optimal spectral purity. If the deviation set is larger than 62,5 kHz, the extended heterodyne band is automatically selected.

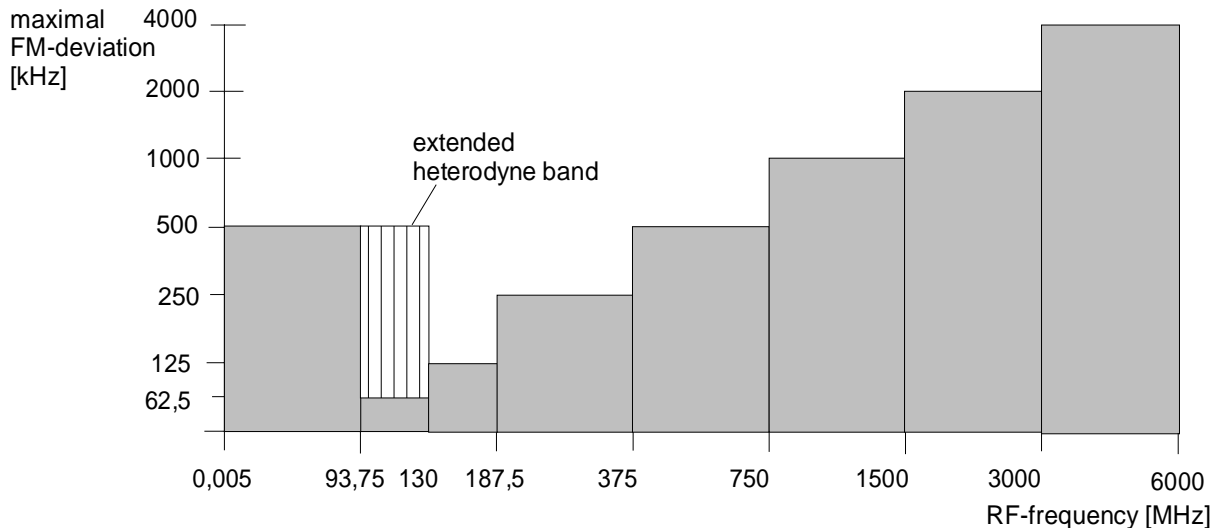

Fig. 2-26 Dependency of the FM maximal deviation on the RF frequency set

### 2.6.2.3.2 Preemphasis

Preemphasis results in a preemphasis of the modulation signal with time constants 50  $\mu$ s or 75  $\mu$ s. The higher frequencies of the modulation signal are preemphasized.

When preemphasis is switched on, only 1/4 of the maximal deviation is permissible. The highest permissible modulation frequency is 15 kHz. Exceeding the permissible modulation frequency can lead to overmodulation.

2.6.2.4 Phase Modulation

Menu MODULATION-PM offers access to settings for phase modulation.

**Note:** The following modulations cannot be set simultaneously and deactivate one another:  
 PM and FM  
 PM and STEREO  
 PM2 SOURCE = LFGEN2 and VOR, ILS, MKR BCN

Menu selection: MODULATION - PM

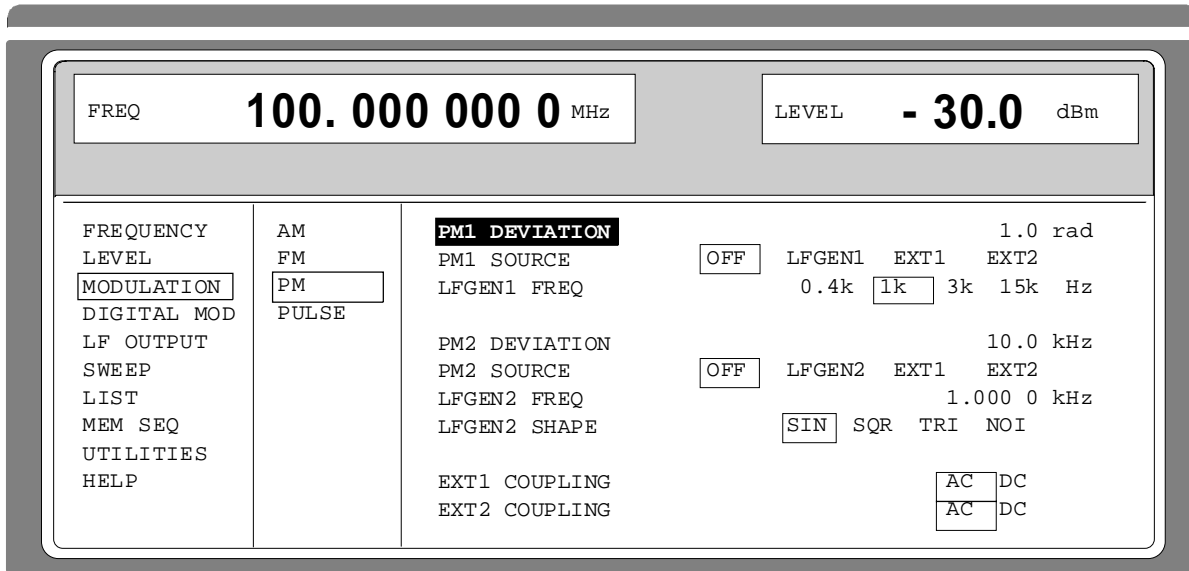

Fig. 2-27 Menu MODULATION - PM (preset setting) fitted with option SM-B2, LF-generator ^ (LFGEN2), and option SM-B5, FM/PM-modulator

- PM1 DEVIATION** Input value of the deviation for PM1.  
IEC-bus command SOUR:PM1 1RAD
- PM1 SOURCE** Switching on and off PM1 and selection of the modulation source.  
IEC-bus command SOUR:PM1:SOUR:INT; STAT ON
- LFGEN1 FREQ** Selection of the frequency of the 1st LF generator.  
IEC-bus command SOUR:PM1:INT:FREQ 1kHz
- PM2 DEVIATION** Input value of the deviation for PM2.  
IEC-bus command SOUR:PM2 1RAD
- PM2 SOURCE** Switching on and off PM2 and selection of the modulation source.  
IEC-bus command SOUR:PM2:SOUR INT; STAT ON
- LFGEN2 FREQ** Input value of the LFGEN2 frequency.  
IEC-bus command SOUR:PM2:INT:FREQ 1kHz
- LFGEN2 SHAPE** Selection of the waveform of the 2nd LF generator.  
IEC-bus command SOUR:SOUR2:FUNC SIN



<b>EXT1 COUPLING</b>	Selection of the type of coupling AC or DC with external supply for PM1 (input EXT1).
	IEC-bus command                      SOUR:PM:EXT1:COUP AC
<b>EXT2 COUPLING</b>	Selection of the type of coupling AC or DC with external supply for PM2 (input EXT2).
	IEC-bus command                      SOUR:PM:EXT2:COUP AC

### 2.6.2.4.1 PM Deviation Limits

The maximal deviation depends on the RF frequency set (cf. Fig. 2-28). It is possible to enter a deviation that is too high for a certain RF frequency or to vary the RF frequency to a range in which the deviation can no longer be set. In this case the maximally possible deviation is set and an error message displayed.

In the RF range 93.75 MHz to 130 MHz a different synthesis range is selected depending on the deviation set. If the deviation is smaller than 0,625 rad, the synthesizer is in the division range with optimal spectral purity. If the deviation set is larger than 0,625 rad, the extended heterodyne band is automatically selected.

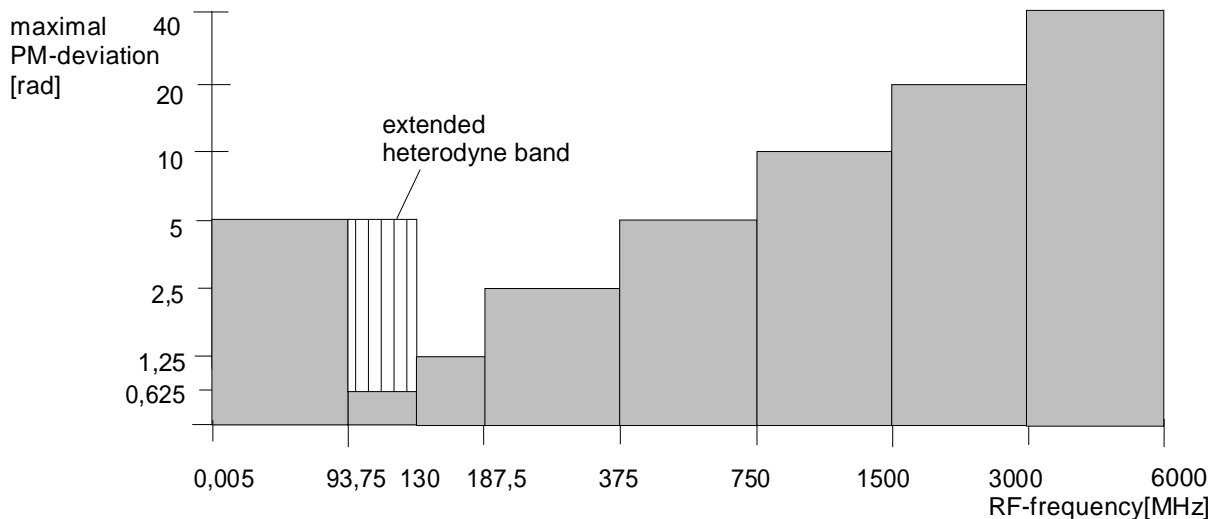

Fig. 2-28 Dependency of the PM maximal deviation on the RF frequency set

### 2.6.2.5 Pulse Modulation

The pulse modulator can be controlled by an external source as well as by the internal pulse generator. In the case of external control, the external source directly feeds the pulse modulator. The envelope of the RF is identical to the control signal. In the case of control by the internal pulse generator, the pulse form of the pulse generator determines the envelope of the RF. Pulse delay, pulse width and period can be set.

The polarity of the pulse modulation is selectable. With POLARITY = NORM, the RF level is on with HIGH level at modulation input PULSE. The input resistance is selectable between 50  $\Omega$  and 10 k $\Omega$ .

#### 2.6.2.5.1 Pulse Generator

As an internal modulation source, the pulse generator (option SM-B4) offers the possibility to set single and double pulses with variable pulse delay, pulse width and period. The pulse generator can be triggered internally or by means of an external signal at the PULSE input. The internal triggering is derived from the reference frequency and hence very stable. In trigger mode EXT, the positive or the negative edge can be used to trigger the pulse generator.

The pulse generator can also be operated as an independent function without the pulse modulator being controlled if the pulse modulation source SOURCE is switched to OFF or EXT. The pulse can be tapped at the VIDEO output.

The inputs and outputs to the pulse generator are at the rear of the instrument.

#### Signal examples:

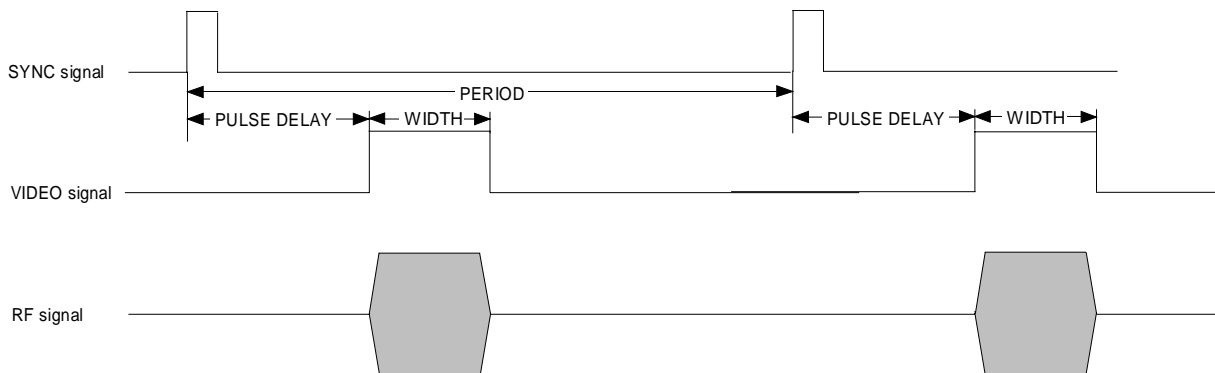

Fig. 2-29 Signal example 1: single pulse, TRIGGER MODE = AUTO

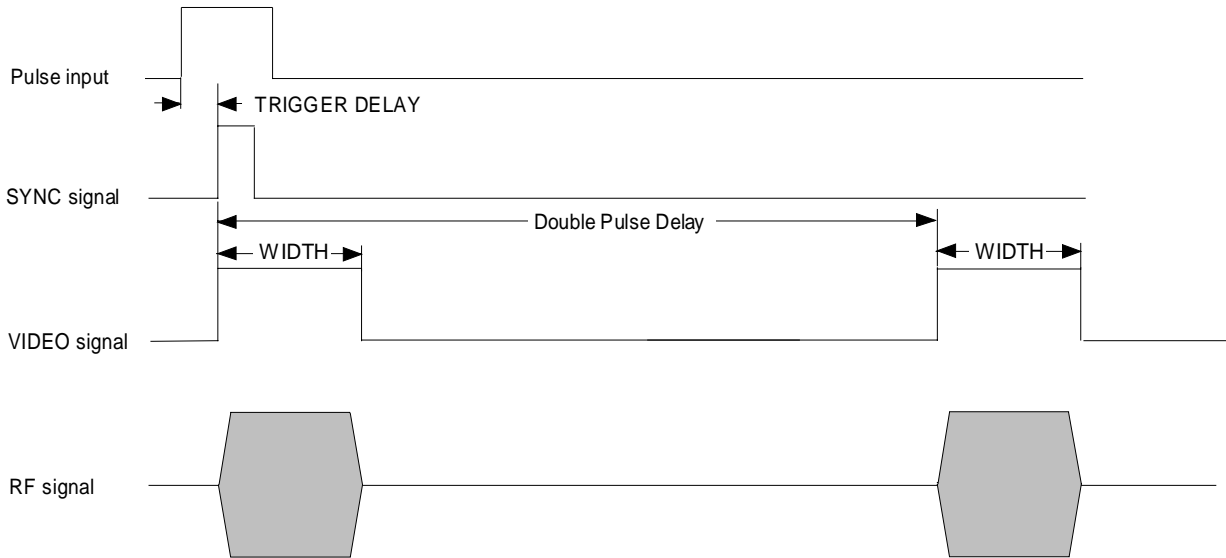

Fig. 2-30 Signal example 2: double pulse, TRIGGER MODE = EXT, SLOPE = POS

**Note:** The minimum period length depends on parameters WIDTH and PULSE DELAY. To avoid a settings conflict the following has to be true:  
 $PERIOD \geq 1,1 \times (WIDTH + PULSE DELAY) + 30 ns$   
 For double pulse the following has to be true:  
 $DOUBLE PULSE DELAY \geq WIDTH + 40 ns$

Menu MODULATION-PULSE offers access to settings for pulse modulation and to the pulse generator. If only option SM-B3, pulse modulator, is fitted, only the first 3 lines are displayed in the setting menu.

Menu selection: MODULATION - PULSE

FREQ <b>100.000 000 0</b> MHz		LEVEL <b>- 30.0</b> dBm	
FREQUENCY	AM	<b>SOURCE</b>	<input type="button" value="OFF"/> EXT PULSE-GEN
LEVEL	FM	POLARITY	<input type="button" value="NORM"/> INV
<input type="button" value="MODULATION"/>	PM	EXT IMPEDANCE	50 <input type="button" value="10 k"/>
DIGITAL MOD	<input type="button" value="PULSE"/>	-----PULSE GENERATOR-----	
LF OUTPUT		PERIODE	10.00 $\mu s$
SWEEP		WIDTH	1.00 $\mu s$
LIST		PULSE DELAY	1.00 $\mu s$
MEM SEQ		DOUBLE PULSE STATE	<input type="button" value="OFF"/> ON
UTILITIES		TRIGGER MODE	<input type="button" value="AUTO"/> EXT
HELP		EXT TRIG SLOPE	<input type="button" value="POS"/> NEG

Fig. 2-31 Menu MODULATION-PULSE (preset setting), fitted with option SM-B3, pulse modulator, and option SM-B4, pulse generator.

<b>SOURCE</b>	Selection of the modulation source. IEC-bus command                    SOUR:PULM:SOUR INT; STAT ON
<b>POLARITY</b>	Selection of the polarity of the modulation NORM    The RF signal is on during high level. INV      The RF signal is suppressed during high level. IEC-bus command                    SOUR:PULM:POL NORM
<b>EXT IMPEDANCE</b>	Selection of the input resistance 50 $\Omega$ or 10 k $\Omega$ . IEC-bus command                    SOUR:PULM:EXT:IMP 50
<b>PERIOD</b>	Input value of the period. IEC-bus command                    SOUR:PULS:PER 10us
<b>WIDTH</b>	Input value of the pulse width. IEC-bus command                    SOUR:PULS:WIDT 1us
<b>PULSE DELAY</b>	Input value of the single-pulse delay. Is only displayed if DOUBLE PULSE STATE is set to be OFF. IEC-bus command                    SOUR:PULS:DEL 1us
<b>DOUBLE PULSE DELAY</b>	Input value of the double-pulse delay. IEC-bus command                    SOUR:PULS:DOUB:DEL 1us
<b>DOUBLE PULSE STATE</b>	Switching on/off the double pulses. ON      Double pulse is switched on OFF     Single pulse IEC-bus command                    SOUR:PULS:DOUB ON
<b>TRIGGER MODE</b>	Selection of the trigger mode. AUTO    Period as entered under PERIOD. EXT     Period is determined by the external signal at the PULSE input. IEC-bus command                    :TRIG:PULS:SOUR AUTO
<b>EXT TRIG SLOPE</b>	Selection of the active edge of the external trigger signal. POS     Pulse generator triggers on positive edge of the external signal. NEG     Pulse generator triggers on negative edge of the external signal.. IEC-bus command                    :TRIG:PULS:SLOP POS

### 2.6.2.6 Stereo Modulation

By means of option SM-B6, multifunction generator, and option SM-B5, FM/PM modulator, stereo multiplex signals conforming to standards can be generated according to the pilot-tone method.

**Note:** The following modulations cannot be set simultaneously and deactivate one another:  
 STEREO and FM  
 STEREO and PM  
 STEREO and AM if SOURCE AM = LFGEN2

Menu selection: MODULATION - STEREO

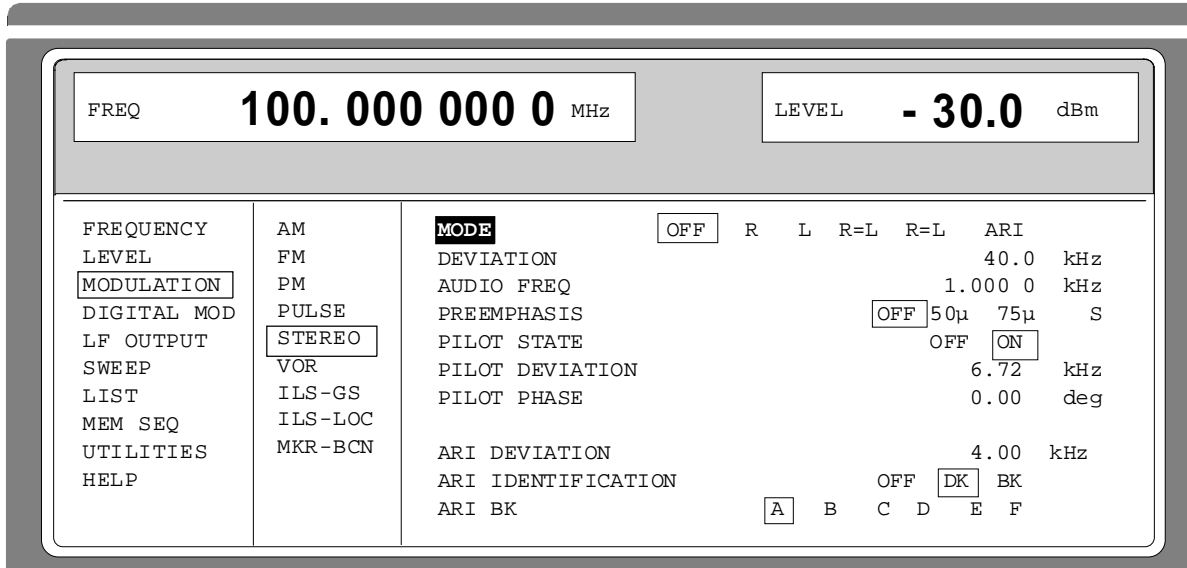

Fig. 2-32 Menu MODULATION-STEREO (preset setting), fitted with option SM-B6, multifunction generator, and option SM-B5, FM/PM modulator

**MODE** Selection of the operating mode.

OFF The stereo signal is switched off.

R Audio signal only in the right-hand channel.

L Audio signal only in the left-hand channel.

R=L Audio signals of same frequency and phase in both channels.

R=L Audio signals of same frequency but opposite phase in both channels.

ARI Generation of 19-kHz pilot tone and ARI traffic channel signals.

IEC-bus command SOUR:STER:STAT ON; SIGN AUD; AUD:MODE LEFT

**DEVIATION** Input value of the frequency deviation of the STEREO-MPX signal without considering the pilot-tone content.

IEC-bus command SOUR:STER 40kHz

**AUDIO FREQ** Input value of the frequency of the audio signal.

IEC-bus command SOUR:STER:AUD 1kHz

<b>PREEMPHASIS</b>	Selection of the preemphasis of the audio signal. 50 uS    Preemphasis 50 $\mu$ s 75 uS    Preemphasis 75 $\mu$ s OFF      Preemphasis switched off IEC-bus command                    SOUR:STER:AUD:PRE OFF
<b>PILOT STATE</b>	Switching on/off the pilot tone. IEC-bus command                    SOUR:STER:PIL:STAT OFF
<b>PILOT DEVIATION</b>	Input value of the frequency deviation of the pilot tone. IEC-bus command                    SOUR:STER:PIL 6720
<b>PILOT PHASE</b>	Input value of the phase of the pilot tone. The zero point of the suppressed 38-kHz subcarrier of the STEREO multiplex signal serves as phase reference. IEC-bus command                    SOUR:STER:PIL:PHAS 0
<b>ARI DEVIATION</b>	Input value of the deviation content of the unmodulated 57-kHz-ARI subcarrier in the ARI operating mode. IEC-bus command                    SOUR:STER:ARI 4kHz
<b>ARI IDENTIFICATION</b>	Selection between ARI broadcasting code (DK) and traffic area code (BK). OFF      The area code and the broadcasting code are switched off. DK      The broadcasting code is activated. The AM modulation depth of the broadcasting code (125 Hz) on the ARI subcarrier is $m=0.3$ . BK      The area code is activated. The AM modulation depth of the area code chosen under ARI BK is $m=0.6$ . IEC-bus command                    SOUR:STER:SIGN ARI;    ARI:TYPE DK
<b>ARI BK</b>	Selection of the standard traffic area codes. A        Traffic area code A, 23,7500 Hz B        Traffic area code B, 28,2738 Hz C        Traffic area code C, 34,9265 Hz D        Traffic area code D, 39,5833 Hz E        Traffic area code E, 45,6731 Hz F        Traffic area code F, 53,9773 Hz IEC-bus command                    SOUR:STER:SIGN ARI;    ARI:TYPE BK;    ARI:BK A

### 2.6.2.7 VOR- / ILS-Test Signals

By means of option SM-B6, multifunction generator, test signals for avionics systems

- VOR            (VHF Omnidirectional Range) ,
- ILS            (Instrument Landing System) and
- MKR-BCN    (Marker Beacon)            can be generated.

### 2.6.2.7.1 VOR Modulation

- Notes:**
- The following modulations cannot be set simultaneously and deactivate one another:  
 VOR and AM  
 VOR and PM if SOURCE PM = LFGEN2  
 VOR and FM if SOURCE FM = LFGEN2
  - In the AM, FM, PM and LF-output menu the message "VOR" is displayed under LFGEN2 if the VOR modulation is activated.

Menu selection: MODULATION-VOR

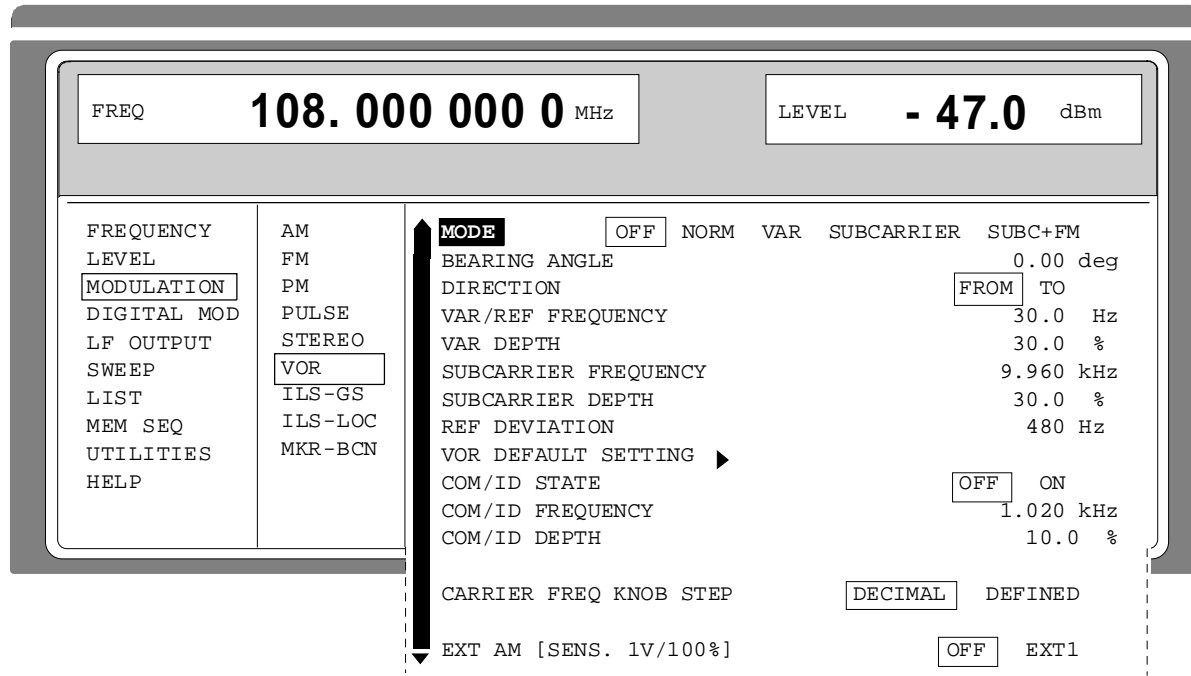

Fig. 2-33 Menu MODULATION-VOR (preset setting), fitted with option SM-B6, multifunction generator

<b>MODE</b>	Selection of the VOR operating mode.
OFF	VOR modulation is switched off. In menus AM, FM, PM and LF-OUTPUT, the original setting is displayed under LFGEN2, the message "VOR" is eliminated.
NORM	VOR modulation is activated.
VAR	Amplitude modulation of the output signal with the 30-Hz signal content of the VOR signal. The modulation depth of the 30-Hz signal corresponds to the value set under VAR DEPTH.
SUBCARRIER	Amplitude modulation of the output signal with the unmodulated 9960-Hz FM carrier of the VOR signal. The modulation depth corresponds to the value set under SUBCARRIER DEPTH.
SUBC+FM	Amplitude modulation of the output signal with the frequency-modulated 9960-Hz FM carrier of the VOR signal. The frequency deviation corresponds to the value set under REF DEVIATION, the modulation depth to the value set under SUBCARRIER DEPTH.

IEC-bus command      SOUR:VOR:STAT ON; MODE NORM

<b>BEARING ANGLE</b>	Input value of the phase angle between the 30-Hz VAR signal and the 30-Hz reference signal. IEC-bus command                      SOUR:VOR 0deg
<b>DIRECTION</b>	Selection of the reference position of the phase information. FROM                      Selection of the beacon as a reference position. The angle set under BEARING ANGLE corresponds to the angle between the true north and the connection line between beacon and airplane. TO                          Selection of the airplane position as a reference position. The angle set under BEARING ANGLE corresponds to the angle between the true north and the connection line between airplane and beacon. IEC-bus command                      SOUR:VOR:DIR FROM
<b>VAR/REF FREQUENCY</b>	Input value of the frequency of the VAR and the REF signal. IEC-bus command                      SOUR:VOR:VAR:FREQ 30
<b>VAR DEPTH</b>	Input value of the AM modulation depth of the 30-Hz VAR signal. IEC-bus command                      SOUR:VOR:VAR 30PCT
<b>SUBCARRIER FREQUENCY</b>	Input value of the frequency of the FM carrier. IEC-bus command                      SOUR:VOR:SUBC 9960
<b>SUBCARRIER DEPTH</b>	Input value of the AM modulation depth of the FM carrier. IEC-bus command                      SOUR:VOR:SUBC:DEPT 30PCT
<b>REF DEVIATION</b>	Input value of the frequency deviation of the REF signal on the FM carrier. IEC-bus command                      SOUR:VOR:REF 480
<b>VOR DEFAULT SETTING</b>	Call the VOR default setting. The default setting corresponds to the setting represented in Fig. 2-33 except for the MODE setting (=NORM). The selection of the CARRIER FREQ KNOB STEP parameters is not changed by calling this function. IEC-bus command                      SOUR:VOR:PRES
<b>COM/ID STATE</b>	Switching on/off an additional communication/identification signal (COM/ID signal). IEC-bus command                      SOUR:VOR:COM ON
<b>COM/ID FREQUENCY</b>	Input value of the frequency of the COM/ID signals. IEC-bus command                      SOUR:VOR:COM:FREQ 1020
<b>COM/ID DEPTH</b>	Input value of the AM modulation depth of the COM/ID signals. IEC-bus command                      SOUR:VOR:COM:DEPT 10PCT



**CARRIER FREQ  
KNOB STEP**

Selection of the variation of the carrier frequency via the rotary knob.

DECIMAL Decimal variation according to the current cursor position.

DEFINED Variation in predefined steps according to the standardized VOR transmitting frequencies (see table, values in MHz):

**Note:** If *DEFINED* is selected, the current RF frequency is automatically switched over to the next VOR transmitting frequency according to the table when switching on modulation VOR.

108.00	109.40	110.80	112.10	112.80	113.50	114.20	114.90	115.60	116.30	117.05	117.75
108.05	109.45	110.85	112.15	112.85	113.55	114.25	114.95	115.65	116.35	117.10	117.80
108.20	109.60	111.00	112.20	112.90	113.60	114.30	115.00	115.70	116.40	117.15	117.85
108.25	109.65	111.05	112.25	112.95	113.65	114.35	115.05	115.75	116.45	117.20	117.90
108.40	109.80	111.20	112.30	113.00	113.70	114.40	115.10	115.80	116.50	117.25	117.95
108.45	109.85	111.25	112.35	113.05	113.75	114.45	115.15	115.85	116.55	117.30	
108.60	110.00	111.40	112.40	113.10	113.80	114.50	115.20	115.90	116.60	117.35	
108.65	110.05	111.45	112.45	113.15	113.85	114.55	115.25	115.95	116.65	117.40	
108.80	110.20	111.60	112.50	113.20	113.90	114.60	115.30	116.00	116.75	117.45	
108.85	110.25	111.65	112.55	113.25	113.95	114.65	115.35	116.05	116.80	117.50	
108.00	110.40	111.80	112.60	113.30	114.00	114.70	115.40	116.10	116.85	117.55	
109.05	110.45	111.85	112.65	113.35	114.05	114.75	115.45	116.15	116.90	117.60	
109.20	110.60	112.00	112.70	113.40	114.10	114.80	115.50	116.20	116.95	117.65	
109.25	110.65	112.05	112.75	113.45	114.15	114.85	115.55	116.25	117.00	117.70	

**EXT AM [SENS. 1V/100%]**

Switching on/off an external modulation signal via socket EXT1.

OFF External AM input EXT1 switched off.

ON External AM input EXT1 activated.  
The sensitivity is 10 mV per percent modulation depth.

IEC-bus command `SOUR:VOR:SOUR INT2,EXT`

**Note:** As automatic level monitoring of the external modulation signal is switched off in this operating mode, there can be an overmodulation as a function of the level of the external signal without a corresponding caution message being generated.

In order to avoid an overmodulation, the peak value of the external signal is to be delimited corresponding to the sum of the modulation depths of the remaining VOR signal components.

2.6.2.7.2 ILS-Glide Slope Modulation (ILS-GS)

- Notes:**
- The following modulations cannot be set simultaneously and deactivate one another: ILS-GS and AM, ILS-GS and PM if SOURCE PM = LFGEN2, ILS-GS and FM if SOURCE FM = LFGEN2
  - In the AM, FM, PM and LF-output menu the message "ILS-GS" is displayed under LFGEN2 if the ILS-GS modulation is activated.
  - With setting CARRIER FREQ KNOB STEP= DEFINED, a change to modulation ILS-LOC automatically causes the RF frequency to be adapted to the localizer value which is coupled to the glide-slope setting.

Menu selection: MODULATION-ILS-GS

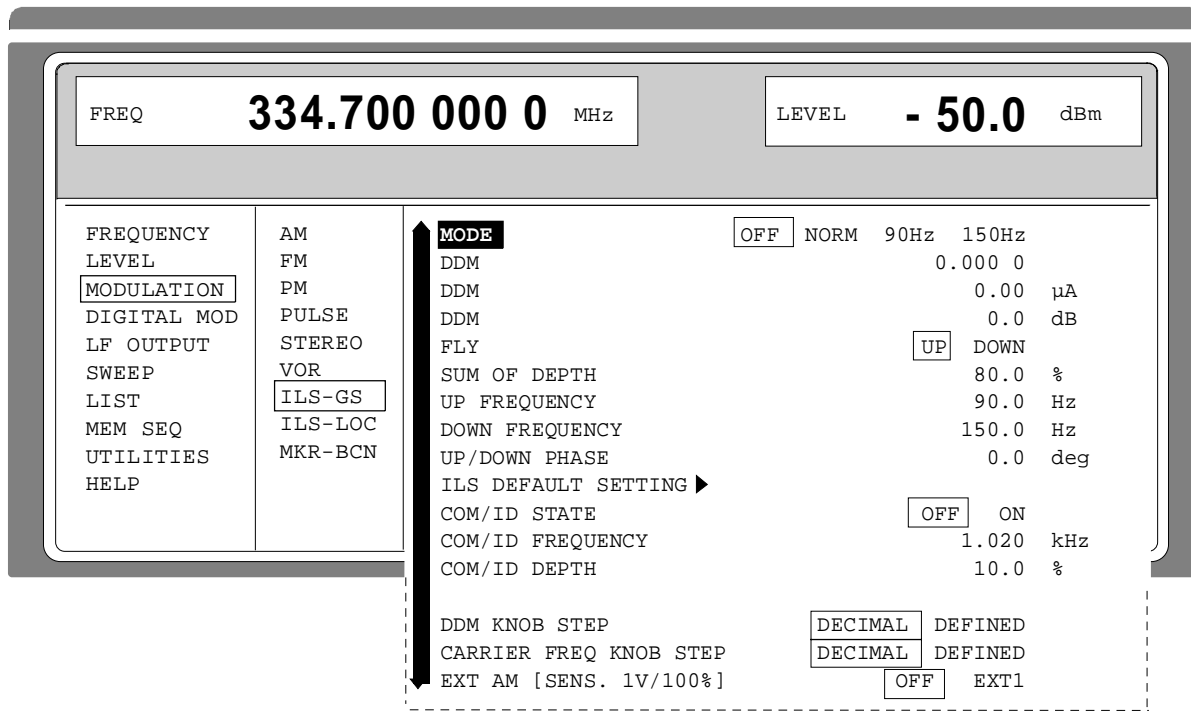

Fig. 2-34 Menu MODULATION-ILS-GS (preset setting), fitted with option SM-B6, multifunction generator

**MODE**

Selection of the ILS-GS operating mode.

- OFF** ILS-GS modulation is switched off. In menus AM, FM, PM and LF-OUTPUT, the original setting is displayed under LFGEN2, the message "ILS-GS" is eliminated.
- NORM** ILS-GS modulation is activated.
- 90 Hz** Amplitude modulation of the output signal with the 90-Hz signal content of the ILS-GS signal. The modulation depth of the 90-Hz signal results from the settings of parameters SUM OF DEPTH (SOD) and DDM according to:  
 $AM(90\text{ Hz}) = 0,5 \times (SOD + DDM \times 100\%)$

150 Hz Amplitude modulation of the output signal with the 150-Hz signal content of the ILS-GS signal. The modulation depth of the 150-Hz signal results from the settings of parameters SUM OF DEPTH (SOD) and DDM acc. to:

$$AM(150\text{ Hz}) = 0,5 \times (\text{SOD} \times \text{DDM} \times 100\%)$$

IEC-bus command `SOUR:ILS:STAT ON; TYPE GS; MODE NORM`

**DDM**

Difference in Depth of Modulation. Input value of the difference in depth of modulation between the 90-Hz and the 150-Hz tone of the ILS-GS modulation signal. The DDM value is calculated to formula (parameter UP/DOWN = DOWN):

$$\text{DDM} = [AM(90\text{ Hz}) - AM(150\text{ Hz})] / 100\%$$

A variation of the DDM value automatically leads to a variation of the value of the instrument current and the DDM value in dB.

IEC-bus command `SOUR:ILS:DDM 0`

**DDM**

Input value of the current of the ILS indicating instrument corresponding to the DDM value. A variation of the value of the instrument current automatically leads to a variation of the DDM value and the DDM value in dB. The value of the instrument current is calculated according to:

$$\text{DDM } \mu\text{ A} = \text{DDM} \times 857,1 \mu\text{ A}$$

IEC-bus command `SOUR:ILS:DDM:CURR 0`

**DDM**

Input of the DDM value in dB. A variation of the value automatically leads to a variation of the DDM value and the value of the instrument current. The dB value is calculated according to:

$$\text{DDM dB} = 20 \times \text{LOG} [(\text{SOD} + \text{DDM} \times 100\%) / (\text{SOD} - \text{DDM} \times 100\%)]$$

IEC-bus command `SOUR:ILS:DDM:LOG 0`

**FLY**

Selection between ILS-GS operating modes UP and DOWN. A change of the setting automatically changes the sign of the DDM value.

UP In operating mode UP, the 150-Hz modulation signal is predominant, the DDM value is positive.

DOWN In operating mode DOWN, the 90-Hz modulation signal is predominant, the DDM value is negative.

IEC-bus command `SOUR:ILS:DDM:DIR UP`

**SUM OF DEPTH**

Input value of the arithmetic sum of the modulation depths of the 90-Hz and 150-Hz ILS-GS signal contents. The RMS modulation depth of the sum signal depends on the phase setting of both modulation tones.

IEC-bus command `SOUR:ILS:SOD 80PCT`

**UP FREQ**

Input value of the modulation frequency of the antenna lobe arranged at the top.

IEC-bus command `SOUR:ILS:ULOB 90`

<b>DOWN FREQ</b>	<p>Input value of the modulation freq. of the antenna lobe arranged at the bottom.</p> <p>IEC-bus command                    SOUR: ILS: LLOB 150</p> <p><b>Note:</b>            <i>A variation of one of the two modulation frequencies causes an automatic adaptation of the other modulation frequency in such a way that a frequency-response ratio of 3:5 or 5:3 is maintained.</i></p>
<b>UP/DOWN PHASE</b>	<p>Input value of the phase between the modulation signals of the upper and lower antenna lobe. The zero point of the 150-Hz signal serves as a reference. The input is effected in degrees of the 150-Hz signal.</p> <p>IEC-bus command                    SOUR: ILS: PHAS 0deg</p>
<b>ILS DEFAULT SETTING</b>	<p>Call the ILS-GS default setting. The default setting corresponds to the setting represented in Fig. 2-34 except for the MODE setting (=NORM). The selection of the CARRIER FREQ KNOB STEP parameter is not changed by calling this function.</p> <p>IEC-bus command                    SOUR: ILS: PRES</p>
<b>COM/ID STATE</b>	<p>Switching on/off an additional communication/identification signal (COM/ID-Signal).</p> <p>IEC-bus command                    SOUR: ILS: COM ON</p>
<b>COM/ID FREQUENCY</b>	<p>Switching on/off an additional communication/identification signal (COM/ID-Signal).</p> <p>IEC-bus command                    SOUR: ILS: COM: FREQ 1020</p>
<b>COM/ID DEPTH</b>	<p>Input value of the AM modulation depth of the COM/ID signal.</p> <p>IEC-bus command                    SOUR: ILS: COM: DEPT 10PCT</p>
<b>DDM KNOB STEP</b>	<p>Input value of the AM modulation depth of the COM/ID signal.</p> <p>DECIMAL    Decimal variation according to the current cursor position.</p> <p>DEFINED    Variation between the predefined DDM values:</p> <p style="padding-left: 40px;">-0,4000</p> <p style="padding-left: 40px;">-0,1750 (Glide Sector)</p> <p style="padding-left: 40px;">-0,0910, 0,0450</p> <p style="padding-left: 40px;">0,0000 (Glide Path)</p> <p style="padding-left: 40px;">+0,0450, +0,0910</p> <p style="padding-left: 40px;">+0,1750 (Glide Sector)</p> <p style="padding-left: 40px;">+0,4000</p>
<b>CARRIER FREQ KNOB STEP</b>	<p>Variation between the predefined DDM values:</p> <p>DECIMAL    Decimal variation according to the current cursor position..</p> <p>DEFINED    Variation in predefined steps according to the standardized GLIDE-SLOPE transmitting frequencies (see table).</p> <p><b>Note:</b>    <i>If DEFINED is selected, the current RF frequency is automatically switched over to the next GLIDE-SLOPE transmitting frequency acc. to the table when switching on the modulation.</i></p>

LOC/GS (MHz)	LOC/GS (MHz)	LOC/GS (MHz)	LOC/GS (MHz)	LOC/GS (MHz)	LOC/GS (MHz)	LOC/GS (MHz)
108.10 / 334.70	108.70 / 330.50	109.30 / 332.00	109.90 / 333.80	110.50 / 329.60	111.10 / 331.70	111.70 / 333.50
108.15 / 334.55	108.75 /330.35	109.35 / 331.85	109.95 / 333.65	110.55 / 329.45	111.15 / 331.55	111.75 / 333.35
108.30 / 334.10	108.90 / 329.30	109.50 / 332.60	110.10 / 334.40	110.70 / 330.20	111.30 / 332.30	111.90 / 331.10
108.35 / 333.95	108.95 / 329.15	109.55 / 332.45	110.15 / 334.25	110.75 / 330.05	111.35 / 332.15	111.95 / 330.95
108.50 / 329.90	109.10 331.40	109.70 / 333.20	110.30 / 335.00	110.90 / 330.80	111.50 / 332.90	
108.55 / 329.75	109.15 / 331.25	109.75 / 333.05	110.35 / 334.85	110.95 / 330.65	111.55 / 332.75	

**EXT AM [SENS. 1V/100%]**

Switching on/off an external modulation signal via socket EXT1.

OFF External AM input EXT1 switched off.

ON External AM input EXT1 activated.

The sensitivity is 10 mV per percent of modulation depth.

IEC-bus command

SOUR:ILS:SOUR INT2, EXT

**Note:** As the automatic level monitoring of the external modulation signal is switched off in this operating mode, there can be an overmodulation as a function of the level of the external signal without a corresponding caution message being generated.

In order to avoid an overmodulation, the peak value of the external signal is to be delimited corresponding to the sum of the modulation depths of the remaining ILS signal components.

2.6.2.7.3 ILS-Localizer Modulation (ILS-LOC)

- Notes:**
- The following modulations cannot be set simultaneously and deactivate one another:  
 ILS-LOC and AM  
 ILS-LOC and PM if SOURCE PM = LFGEN2  
 ILS-LOC and FM if SOURCE FM = LFGEN2
  - In the AM, FM, PM and LF-output menu the note "ILS-LOC" is displayed under LFGEN2 if the ILS-LOC modulation is activated.
  - With setting CARRIER FREQ KNOB STEP= DEFINED, a change to modulation ILS-GS automatically causes the RF frequency to be adapted to the glide-slope value which is coupled to the localizer setting.

Menu selection: MODULATION ILS - LOC

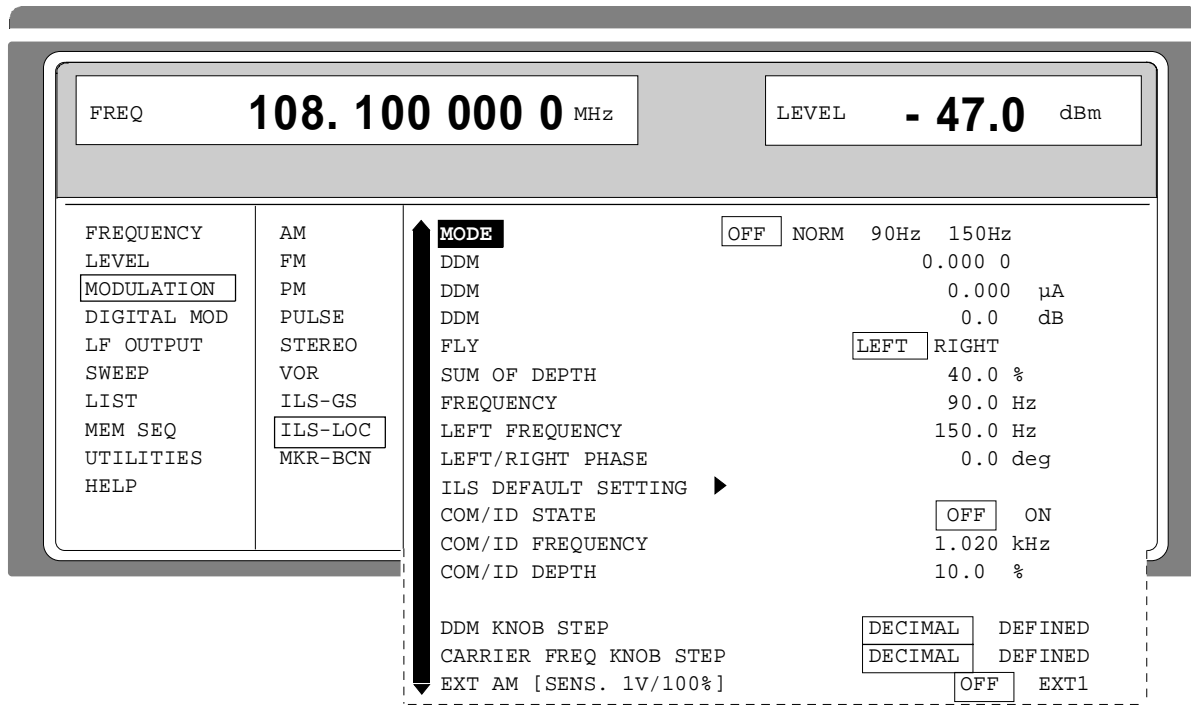

Fig. 2-35 Menu MODULATION-ILS-LOC (preset setting), fitted with option SM-B6, multifunction generator

**MODE**

Selection of the ILS-LOC operating mode.

**OFF** ILS-LOC modulation is switched off. In menus AM, FM, PM and LF-OUTPUT the original setting is displayed under LFGEN2, the note "ILS-LOC" is eliminated.

**NORM** ILS-LOC modulation is activated.

**90 Hz** Amplitude modulation of the output signal with the 90-Hz signal content of the ILS-LOC signal. The modulation depth of the 90-Hz signal is calculated from the settings of parameters SUM OF DEPTH (SOD) and DDM according to:

$$AM(90\text{ Hz}) = 0,5 \times (SOD + DDM \times 100\%)$$

150 Hz Amplitude modulation of the output signal with the 150-Hz signal content of the ILS-LOC signal. The modulation depth of the 150-Hz signal results from the settings of parameters SUM OF DEPTH (SOD) and DDM according to:  

$$AM(150\text{ Hz}) = 0,5 \times (\text{SOD} - \text{DDM} \times 100\%)$$

IEC-bus command

SOUR:ILS:STAT ON; TYPE LOC; LOC:MODE NORM

## DDM

Difference in Depth of Modulation.

Input value of the difference in depth of modulation between the 90-Hz and the 150-Hz tone of the ILS-LOC modulation signal. The DDM value is calculated according to the following formula (parameter LEFT/RIGHT = RIGHT):

$$\text{DDM} = [ \text{AM}(90\text{ Hz}) - \text{AM}(150\text{ Hz}) ] / 100\%$$

If LEFT of parameter LEFT/RIGHT is selected, negative DDM values result with otherwise same setting. A variation of the DDM value automatically leads to a variation of the DDM value in dB and the value of the instrument current.

IEC-bus command

SOUR:ILS:LOC:DDM 0

## DDM

Input value of the current of the ILS indicating instrument corresponding to the DDM value.

A variation of the value of the instrument current automatically leads to a variation of the DDM value and the DDM value in dB. The value of the instrument current is calculated according to:

$$\text{DDM } \mu\text{A} = \text{DDM} \times 857,1 \mu\text{A}$$

IEC-bus command

SOUR:ILS:LOC:DDM:CURR 0

## DDM

Input of the DDM value in dB.

A variation of the DDM value in dB automatically leads to a variation of the value of the instrument current and of the DDM value. The dB value is calculated according to:

$$\text{DDM dB} = 20 \times \text{LOG} [(\text{SOD} + \text{DDM} \times 100\%) / (\text{SOD} - \text{DDM} \times 100\%)]$$

IEC-bus command

SOUR:LOC:DDM:LOG 0

## FLY

Selection between ILS-LOC operating modes LEFT and RIGHT. A change of the setting automatically changes the sign of the DDM value.

**LEFT** In the LEFT operating mode, the content of the 150-Hz modulation signal is predominant. The DDM value is negative.

**RIGHT** In the RIGHT operating mode, the content of the 90-Hz modulation signal is predominant. The DDM value is positive..

IEC-bus command

SOUR:ILS:LOC:DDM:DIR LEFT

## SUM OF DEPTH

Input value of the arithmetic sum of the modulation depths of 90-Hz and 150-Hz ILS-LOC signal contents. The RMS modulation depth depends on the phase setting of both modulation tones.

IEC-bus command

SOUR:ILS:LOC:SOD 40PCT

<b>LEFT FREQUENCY</b>	<p>Input value of the modulation frequency of the antenna lobe arranged at the left viewed from the plane.</p> <p>IEC-bus command                    SOUR: ILS: LOC: LLOB 90</p>
<b>RIGHT FREQUENCY</b>	<p>Input value of the modulation frequency of the antenna lobe arranged at the right viewed from the plane.</p> <p>IEC-bus command                    SOUR: ILS: LOC: RLOB 150</p> <p><b>Note:</b> <i>A variation of one of the two modulation frequencies causes an automatic adaptation of the other modulation frequency in such a way that a frequency-response ratio of 3:5 or 5:3 is maintained.</i></p>
<b>LEFT/RIGHT PHASE</b>	<p>Input value of the phase between the modulation signals of the left-hand and right-hand antenna lobe. The zero point of the 150-Hz signal serves as a reference.</p> <p>The input is effected in degrees of the 150-Hz signal.</p> <p>IEC-bus command                    SOUR: ILS: LOC: PHAS 0deg</p>
<b>ILS DEFAULT SETTING</b>	<p>Calling the ILS-LOC default setting.</p> <p>The default setting corresponds to the setting represented in Fig. 2-35 except for the MODE setting (=NORM). The selection of the CARRIER FREQ KNOB STEP parameter is not changed by calling this function.</p> <p>IEC-bus command                    SOUR: ILS: LOC: PRES</p>
<b>COM/ID STATE</b>	<p>Switching on/off an additional communication/identification signal (COM/ID signal).</p> <p>IEC-bus command                    SOUR: ILS: LOC: COM ON</p>
<b>COM/ID FREQUENCY</b>	<p>Switching on/off an additional communication/identification signal (COM/ID signal).</p> <p>IEC-bus command                    SOUR: ILS: LOC: COM: FREQ 1020</p>
<b>COM/ID DEPTH</b>	<p>Input value of the AM modulation depth of the COM/ID signal.</p> <p>IEC-bus command                    SOUR: ILS: LOC: COM: DEPT 10PCT</p>
<b>DDM KNOB STEP</b>	<p>Selection of the variation of the DDM value via the rotary knob.</p> <p>DECIMAL    Decimal variation according to the current cursor position.</p> <p>DEFINED    Variation between the predefined DDM values:</p> <p style="margin-left: 40px;">-0,2000,</p> <p style="margin-left: 40px;">-0.1550 (Course Sector)</p> <p style="margin-left: 40px;">-0,0930, -0,0460</p> <p style="margin-left: 40px;">  0,0000 (Course Line)</p> <p style="margin-left: 40px;">+0,0460, +0,0930</p> <p style="margin-left: 40px;">+0,1550 (Course Sector)</p> <p style="margin-left: 40px;">+0,2000</p>



- CARRIER FREQ KNOB STEP** Selection of the variation of the carrier frequency via the rotary knob. The selection is effective on both ILS modulations.
- DECIMAL Decimal variation according to the current cursor position.
- DEFINED Decimal variation according to the current cursor position.
- Note:** *If DEFINED is selected, the current RF frequency is automatically switched over to the next LOCALIZER transmitter frequency according to the table when switching on the modulation.*
- EXT AM [SENS. 1 V/100%]** Switching on/off an external modulation signal via socket EXT1.
- OFF External AM input EXT1 switched off.
- ON External AM input EXT1 activated.  
The sensitivity is 10 mV per percent modulation depth.
- IEC-bus command `SOUR:ILS:SOUR INT2, EXT`
- Note:** *As automatic level monitoring of the external modulation signal is switched off in this operating mode, there can be an overmodulation as a function of the level of the external signal without a corresponding caution message being generated.*  
*In order to avoid an overmodulation, the peak value of the external signal is to be delimited corresponding to the sum of the modulation depths of the remaining ILS signal components.*

2.6.2.7.4 Marker Beacon

- Notes:**
- The following modulations cannot be set simultaneously and deactivate one another: MKR-BCN and AM, MKR-BCN and PM if SOURCE PM = LFGEN2  
MKR-BCN and FM if SOURCE FM = LFGEN2
  - In the AM, FM, PM and LF-output menu the note "MKR-BCN" is displayed under LFGEN2 if the MKR-BNC modulation is activated.

Menu selection: MODULATION-MKR-BCN

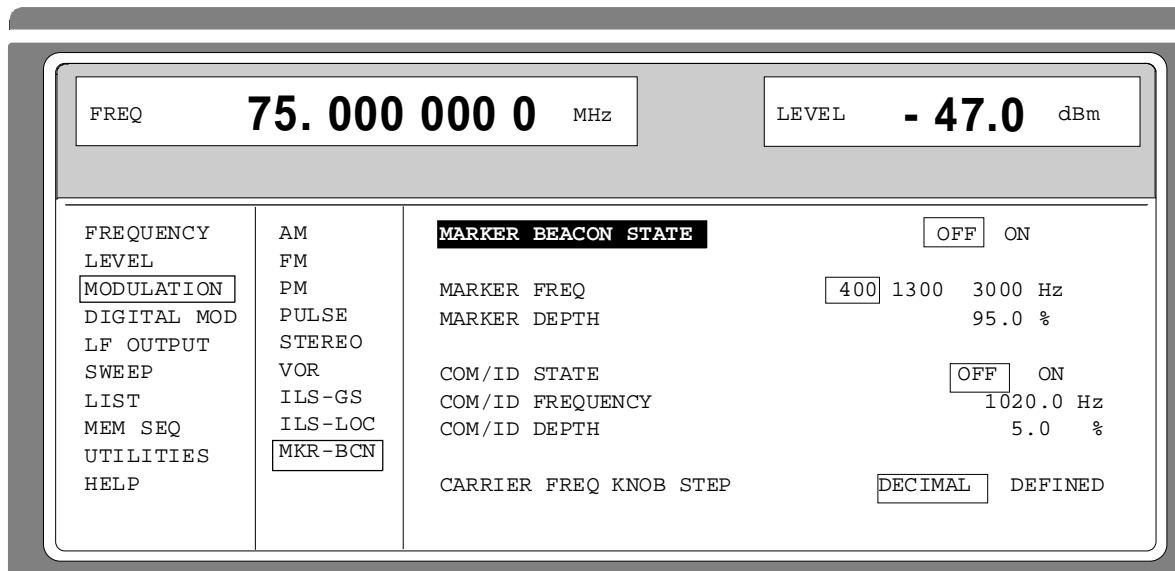

Fig. 2-36 Menu MODULATION-MKR-BCN (preset settings), fitted with option SM-B6, multifunction generator.

<b>MARKER BEACON STATE</b>	Switching on and off the marker-beacon signal. IEC-bus command            SOUR:MBE:STAT ON
<b>MARKER FREQ</b>	Switching on and off the marker-beacon signal. IEC-bus command            SOUR:MBE:FREQ 400
<b>MARKER DEPTH</b>	Input value of the modulation depth of the marker-beacon signals. IEC-bus command            SOUR:MBE:DEPT 95PCT
<b>COM/ID STATE</b>	Switching on and off an additional communication/identification signal (COM/ID signal). IEC-bus command            SOUR:MBE:COM ON
<b>COM/ID FREQUENCY</b>	Input value of the frequency of the COM/ID signal. IEC-bus command            SOUR:MBE:COM:FREQ 1020
<b>COM/ID DEPTH</b>	Input value of the AM modulation depth of the COM/ID signal. IEC-bus command            SOUR:MBE:COM:DEPT 5PCT

- CARRIER FREQ KNOB STEP** Selection of the variation of the carrier frequency via the rotary knob.
- DECIMAL Decimal variation according to the current cursor position.
- DEFINED Variation in predefined steps according to the standardized marker beacon transmitter frequencies (s. table, val. in MHz).

**Note:** *If DEFINED is selected, the current RF frequency is automatically switched over to the next marker beacon transmitter frequency when switching on the modulation.*

74.600	75.675	74.750	74.825	74.900	74.975	75.050	75.125	75.200	75.275	75.350
74.625	74.700	74.775	74.850	74.925	75.000	75.075	75.150	75.225	75.300	75.375
74.650	74.725	74.800	74.875	74.950	75.025	75.100	75.175	75.250	75.325	75.400

### 2.6.3 Digital Modulation

The SME offers the following digital modulations (option SME-B11, DM coder):

- **GMSK** for
 

GSM/PCN	( <u>G</u> lobal <u>S</u> ystem for <u>M</u> obile <u>C</u> ommunications/ <u>P</u> ersonal <u>C</u> ommunication <u>S</u> ystem)
CDPD	( <u>C</u> ellular <u>D</u> igital <u>P</u> acket <u>D</u> ata)
MC9	(French Communication network)
MOBITEX	(Mobile data system)
DSRR	( <u>D</u> igital <u>S</u> hort <u>R</u> ange <u>R</u> adio)
MD24 to MD192	(Standards according to ETS specifications)
  
- **GFSK** for
 

DECT	( <u>D</u> igital <u>E</u> uropean <u>C</u> ordless <u>T</u> elephony)
CT2	( <u>C</u> ordless <u>T</u> elephony)
CT3	( <u>C</u> ordless <u>T</u> elephony)
  
- **QPSK** for
 

NADC	( <u>N</u> orth <u>A</u> merican <u>D</u> igital <u>C</u> ellular)
PDC	( <u>P</u> acific <u>D</u> igital <u>C</u> ellular)
TFTS	( <u>T</u> errestrial <u>F</u> light <u>T</u> elephone <u>S</u> ystem)
APCO25	( <u>A</u> ssociation of <u>P</u> ublic <u>S</u> afety <u>C</u> ommunications <u>O</u> fficers, Project 25)
TETRA	( <u>T</u> rans <u>E</u> uropean <u>T</u> runked <u>R</u> adio)
MSAT	( <u>M</u> obile <u>S</u> atellite)
INMARSAT-M	( <u>I</u> nternational <u>M</u> aritime <u>S</u> atellite)
  
- **FSK** for
 

POCSAG	( <u>P</u> ost <u>O</u> ffice <u>C</u> ode <u>S</u> tandardization <u>A</u> dvisory <u>G</u> roup)
CITYRUF	(German pager system)
FLEX	( <u>F</u> lexible High Speed Paging System)
  
- **4FSK** for
 

ERMES	( <u>E</u> uropean <u>R</u> adio <u>M</u> essage <u>S</u> ystem)
APCO25	( <u>A</u> ssociation of <u>P</u> ublic <u>S</u> afety <u>C</u> ommunications <u>O</u> fficers, Project 25)
FLEX	( <u>F</u> lexible High Speed Paging System)
MODACOM	( <u>M</u> obile <u>D</u> ata <u>C</u> ommunication)
  
- **FFSK** for
 

POCSAG	( <u>P</u> ost <u>O</u> ffice <u>C</u> ode <u>S</u> tandardization <u>A</u> dvisory <u>G</u> roup)
--------	--

Internal or external data sources can be used. A PRBS generator with selectable sequence lengths and a data generator (RAM) are available as an internal data source. Option SME-B12, memory extension, increases the memory depth to 8 MBit.

Option SME-B12, memory extension, can be used to set radiocommunication service ERMES directly, cf. Section "Radiocommunication Service ERMES".

Option SME-B41, FLEX, together with option SME-B12, memory extension, can be used to generate call signals complying to the FLEX standard, cf. Section "Radiocommunication Service FLEX".

Option SME-B42, POCSAG, together with option SME-B12, memory extension, can be used to generate call signals complying to the POCSAG standard, cf. Section "Radiocommunication Service POCSAG".

Option SME-B43, REFLEX, together with option SME-B12, memory extension, can be used to generate call signals complying to the ReFLEX standard. , cf. Section "Radiocommunication Service REFLEX".

### 2.6.3.1 Data Generator

The data generator contains a memory for the data (DATA), for level switchover (LEV ATT) and for the BURST output (BURST) each. The data generator can be programmed via the IEC bus or manually using the list editor (cf. Fig. 2-37). The maximal memory capacity is 8192 bits. The data generator can also be programmed for shorter sequences. The data of all three memories are combined in a list. Up to 10 different lists can be stored in the instrument.

Option SME-B12, DM memory extension, increases the memory depth to 8 MBit (cf. Section 2.6.3.3, DM memory extension, option SME-B12).

The DATA memory contains the modulation data bits.

The LEV-ATT memory contains the bits to control the level reduction. A logic "0" means the level indicated in the header field. A logic "1" means a level reduction by the value indicated in the menu under LEVEL ATTENUATION. For a constant carrier, either the bits of the LEV-ATT list or the parameter LEVEL ATTENUATION must be set to 0.

The BURST memory contains the bits to control the BURST output. A logic "1" means level HIGH. A logic "0" means level LOW.

What is to be observed is that the modulation generation is subject to a delay that must not be neglected. In order to keep the level reduction or the BURST signal synchronous with the modulation, these memories are to be programmed offset by the delay. The delays of the different modulations are listed in table 2-5, radio network data (cf. Fig. 2-38, signal example with respect to DM delay as well).

Sockets DATA, CLOCK and BURST are switched to be an output if the data generator is switched on, and the bit sequences can be tapped there. The BURST output can be used to control the pulse modulator or to trigger the LIST mode, if there is an external cable connection from the PULSE input or TRIGGER input at the rear of the unit.

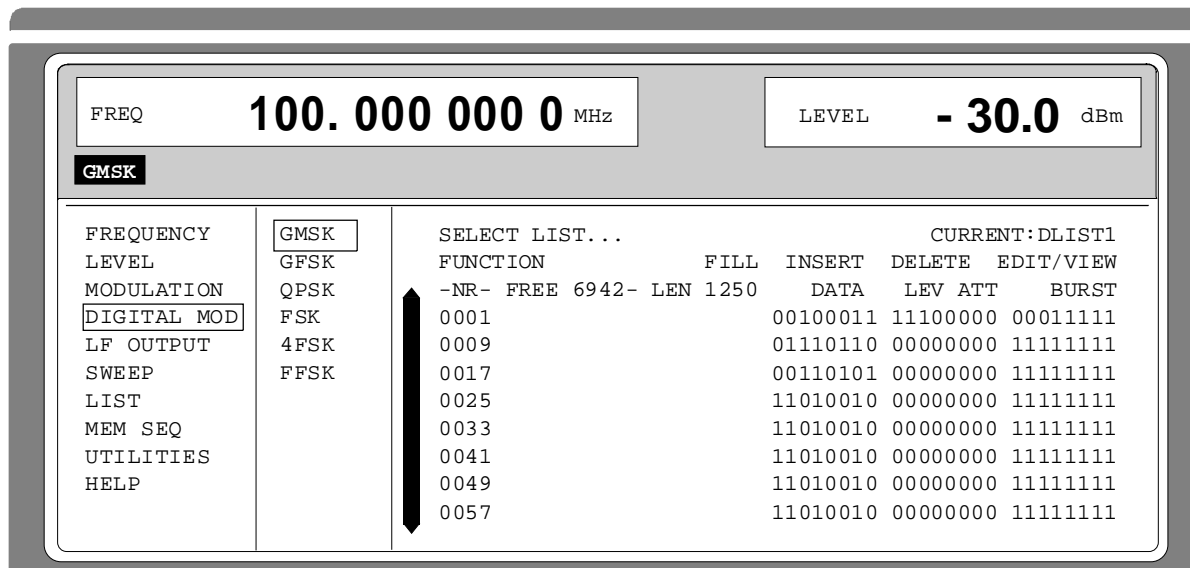

Fig. 2-37 Menu DIGITAL MOD-GMSK, edit page

IEC-bus commands for programming the data generator::

```
:DM:DATA:SEL "DLIST1"
:DM:DATA:DATA 0,0,1,0,0,0,0,1,1,0,1,1,1,0,1,1,0
:DM:DATA:ATT 1,1,1,0,0,0,0,0,0,0,0,0,0,0,0,0,0
:DM:DATA:BURS 0,0,0,1,1,1,1,1,1,1,1,1,1,1,1,1,1
```

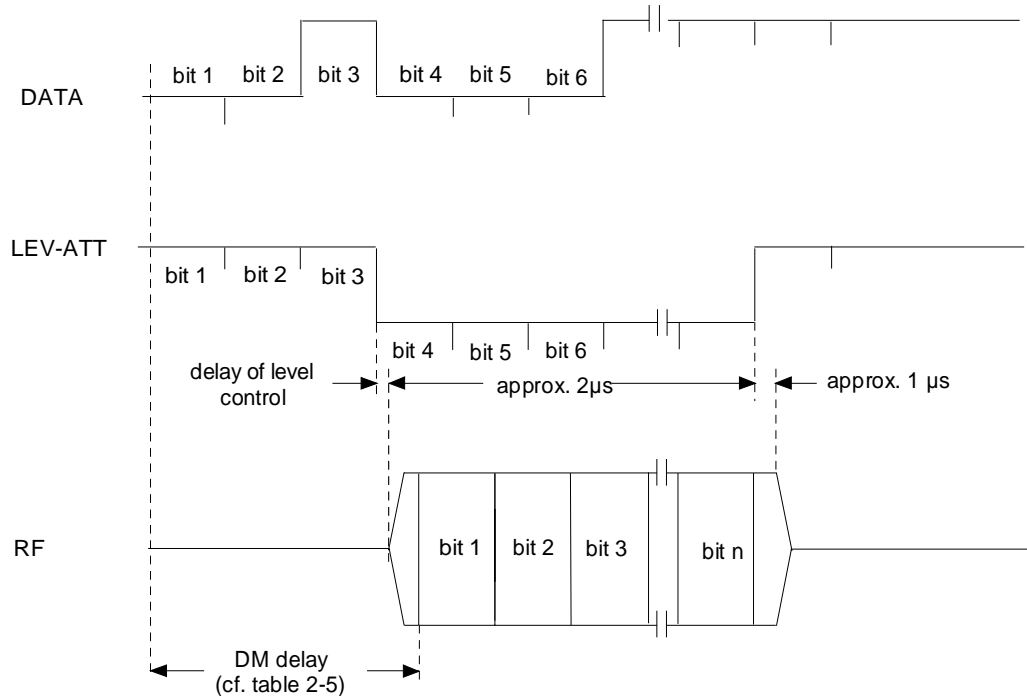

Fig. 2-38 Signal example with respect to DM delay and delays of level control

### 2.6.3.2 PRBS Generator

The PRBS generator (Pseudo Random Binary Sequence) supplies pseudo random bit sequences with sequence lengths of

- $2^9-1 = 511$  ( 9 bit),
- $2^{15}-1 = 32767$  (15 bit),
- $2^{20}-1 = 1048575$  (20 bit),
- $2^{21}-1 = 2097151$  (21 bit) or
- $2^{23}-1 = 8388607$  (23 bit)

If the PRBS generator is switched on, the PRBS bit sequence replaces the data bit sequence of the data generator. The programming of the level reduction and the BURST output remains valid even if the PRBS generator is switched on. For a constant carrier, either the bits of the LEV-ATT list or parameter LEVEL ATTENUATION must hence be set to 0.

Sockets DATA, CLOCK and BURST are switched to be an output if the PRBS generator is switched on, and the bit sequences can be tapped there.

### 2.6.3.3 DM Memory Extension, Option SME-B12

Option SME-B12, memory extension, increases the memory depth of the data generator. The memory depth depends on the selection of the memory space allocation (MEM MODE, cf. submenu CONFIG XMEM...). If the entire memory area is allocated to the DATA memory (MEM MODE 8M\*1), the memory depth is increased to 8 MBit. If the memory area is divided up into the three memories DATA, LEV-ATT and BURST (MEM MODE 1M\*3), however, the memory depth is decreased to 1 MBit.

In the DM menus, the memory extension can be activated in submenu SELECT LIST... by selecting list "XMEM".

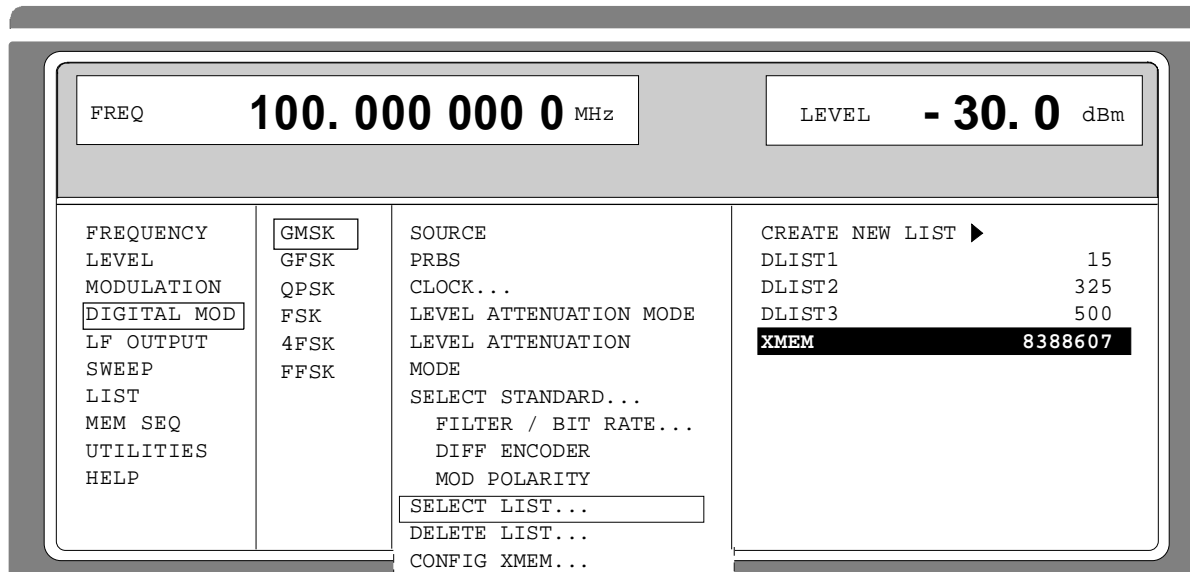

Fig. 2-39 Selection of the memory extension in submenu SELECT LIST...

Compared to all other lists, list "XMEM" is special for the following reasons:

- It cannot be processed using the list editor. The data are either loaded externally via the DATA socket (RECORD DATA→) or entered via the IEC bus or the RS-232 interface.
- List "XMEM" cannot be deleted. The previous data of a certain memory area are overwritten when new data are read into this memory area.
- List "XMEM" can be divided up into several sublists (memory areas). The memory areas are defined by the start address and the length of the data sequence. Their contents is permanently stored.

For modulation types QPSK and 4FSK it should be noted that a symbol is coded with two bits, the X bit and the Y bit. If data lists for these modulations are to be stored in the memory extension, three operating modes can be selected, each storing the X and Y bits in the "XMEM" list in a different way. Switchover between the different modes is not possible without a change of the XMEM data:

1. CLOCK MODE BIT  
MEM MODE 8M\*1  
In this mode, X and Y bits are stored serially in the "XMEM" list and are transmitted via the DATA line. The X bit can be found at the start address.
2. CLOCK MODE BIT  
MEM MODE 1M\*3  
In this mode, the X and Y bits are also stored serially in the "XMEM" list and are transmitted via the DATA line. The X bit can be found at the start address. The LEV-ATT (level reduction) and the BURST channel can be used.
3. CLOCK MODE SYMB  
MEM MODE 1M\*3  
(DM Coder VAR.4/REV.1 or higher)  
In this mode, X and Y bits are stored in parallel in the "XMEM" list and are transmitted in parallel via the DATA or BURST line. The LEV-ATT channel can be used for level reduction.

During the serial operating modes 1 and 2 (bit clock) the DM coder and the memory extension are synchronized with regard to the X and Y bit, if one of the settings (e.g. BITRATE or LENGTH) is changed. As this synchronization is effected via the trigger input of the memory extension (EXT TRIG), it is not possible to externally trigger the memory extension. The external trigger mode has to be switched off (EXT TRIGGER = OFF). If EXT TRIGGER is ON an error message is displayed.

In the parallel operating mode 3 (symbol clock) the synchronization is not required and the memory extension can be externally started via connector TRIGGER (EXT TRIGGER = ON is allowed).

By selecting list "XMEM", list editor line FUNCTION is replaced by submenu CONFIG XMEM...which contains the parameters of the memory extension.

Menu selection DIGITAL MOD - „DM“ - CONFIG XMEM...

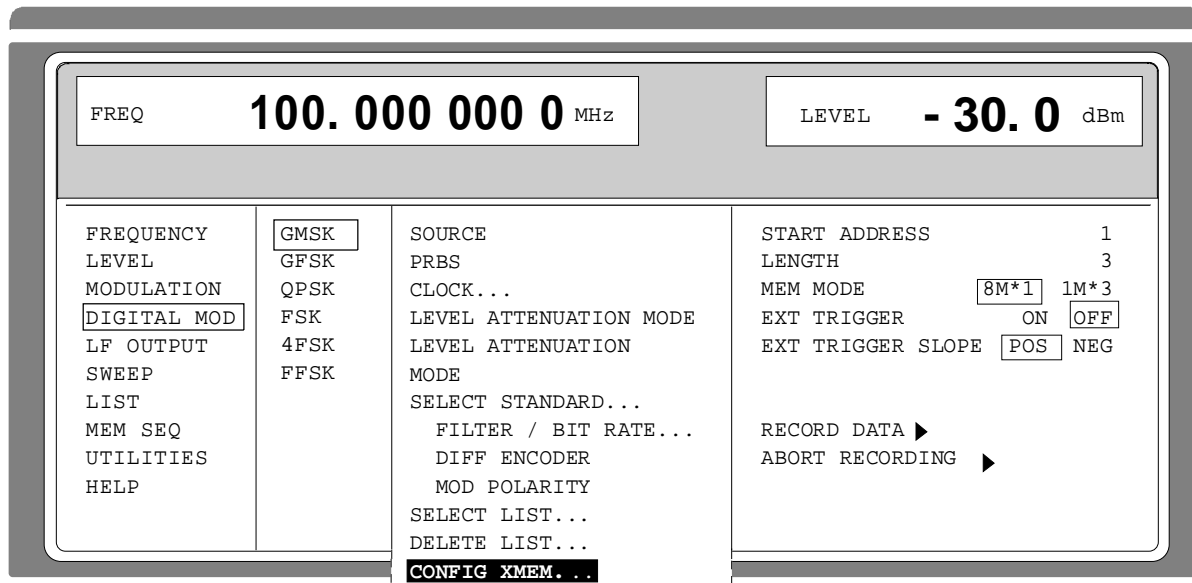

Fig. 2-40 Submenu DIGITAL MOD-GMSK-CONFIG XMEM...



<b>START ADDRESS</b>	<p>Input value of the start address</p> <p>Input range in mode 8M*1: 1 to 8388478</p> <p>Input range in mode 1M*3: 1 to 1048558.</p> <p>IEC-bus command : SOUR:DM:DATA:XMEM:STAR 1</p>
<b>LENGTH</b>	<p><b>LENGTH</b> Input value of the sequence length.</p> <p>For a start address = 1 the following applies:</p> <p>Input range in mode 8M*1: 3 to 8388480</p> <p>Input range in mode 1M*3: 3 to 1048560.</p> <p>On increasing the start address, the maximum sequence length is reduced correspondingly. If the maximum value is exceeded, an error message is displayed.</p> <p>IEC-bus command : SOUR:DM:DATA:XMEM:LENG 3</p>
<b>MEM MODE</b>	<p><b>MEM MODE</b> Selection of the allocation of the memory area.</p> <p>8M*1 The 8-MBit memory area can only be used for data.</p> <p>1M*3 The memory area is divided up into DATA, LEV ATT and BURST. The memory depth is 1 MBit.</p> <p>IEC-bus command : SOUR:DM:DATA:XMEM:MODE DATA</p>
<b>EXT TRIGGER</b>	<p>Switching on/off the external trigger facility.</p> <p>ON The run of the list is triggered by the external trigger signal. Each trigger signal starts a new run beginning with the start address.</p> <p>OFF The external trigger mode is switched off.</p> <p>IEC-bus command : SOUR:DM:DATA:XMEM:TRIG ON</p>
<b>EXT TRIGGER SLOPE</b>	<p>Selection of the active edge of the external trigger signal.</p> <p>POS The sequence starts with the positive edge of the trigger signal.</p> <p>NEG The sequence starts with the negative edge of the trigger signal</p> <p>IEC-bus command : SOUR:DM:DATA:XMEM:TRIG:SLOP POS</p>
<b>RECORD DATA →</b>	<p>Starts the recording of data from an external source via the DATA input (cf. Section "Recording a Data Sequence from an External Source (External Loading)"). Recording can be effected by means of both an external or internal clock. The clock can be selected in the CLOCK submenu (cf. Section "QPSK modulation").</p> <p>During the time of recording, the note "RECORDING" is displayed on the right side of the line. When recording has been finished, the note "DONE" is displayed for a short time.</p> <p><b>Note:</b> Recording is only possible if SOURCE EXT is activated.</p> <p>IEC-bus command : SOUR:DM:DATA:XMEM:REC</p>
<b>ABORT RECORDING →</b>	<p>Aborts a running recording. The note "ABORTED" is displayed at the right margin of the line for a short time. The data recorded up to the point of time of the abortion remain in the memory.</p> <p>IEC-bus command : ABORT:XMEM</p>

### 2.6.3.3.1 Recording a Data Sequence from an External Source (External Loading)

- |                               |   |
|-------------------------------|---|
| Call DM menu                  | ➤ Mark one of the digital modulations using the menu cursor and press key [SELECT].   |
| Select external               | ➤ Mark parameter SOURCE using the menu cursor and press key [SELECT].<br>➤ Mark selection EXT using the menu cursor and press key [SELECT].   |
| Set the bit rate              | ➤ Mark submenu SELECT STANDARD... using the menu cursor and press key [SELECT].<br>➤ Mark one of the standards using the menu cursor and press key [SELECT].<br>or<br>➤ Mark parameter BITRATE using the menu cursor and press key [SELECT].<br>➤ Enter the bit rate using rotary knob or numeric key and press key [1 x ENTER].  |
| Memory extension              | ➤ Mark submenu SELECT LIST... using the menu cursor and press key [SELECT].<br>➤ Mark list XMEM using the menu cursor and press key [SELECT].   |
| Define memory area and memory | <p><b>Note:</b> <i>In recording, the memory area is overwritten from the start area and memory address to the stop address (START ADDRESS + LENGTH - 1) Up to 7 bits below the start address and up to 15 bits above the stop address (START ADDRESS + LENGTH - 1) are additionally overwritten with a random value. The additional bits must be considered if a new recording is to be effected between recordings already stored.</i></p> <p>➤ Mark submenu CONFIG XMEM... using the menu cursor and press key [SELECT].</p> <p>➤ Mark parameter START ADDRESS using the menu cursor and press key [SELECT].</p> <p>➤ Enter the start address using rotary knob or numeric keys and press key [1 x ENTER].</p> <p>➤ Enter the start address using rotary knob or numeric keys and press key [1 x ENTER].</p> <p>➤ Mark parameter LENGTH using the menu cursor and press key [SELECT].</p> <p>➤ Enter the sequence length using rotary knob or numeric keys and press key [1 x ENTER].</p> <p>➤ Mark parameter MODE using the menu cursor and press key [SELECT].</p> <p>➤ Mark selection 8M*1 using the menu cursor and press key [SELECT].</p> |

- Select external clock
- Mark submenu CLOCK... using the menu cursor and press key [SELECT].
  - Mark parameter CLOCK SOURCE using the menu cursor and press key [SELECT].
  - Mark selection COUPLED using the menu cursor and press key [SELECT].
- Connect external
- Connect the data source to input socket DATA of the SME.
  - Connect the clock source to input socket CLOCK of the SME.
- Recording
- Mark action RECORD DATA → to be executed using the menu cursor and press key [SELECT].
- If parameter CLOCK EDGE is set on POS, the data with the positive clock edge is read in.

The data sequence recorded can be activated as an internal source by switching over parameter SOURCE from EXT to DATA in the DM menu after the recording.

The above example describes the recording of a DATA sequence in the 8M\*1 mode (MEM MODE 8M\*1). For recording in the 1M\*3 mode the same settings can be used except for selection 1M\*3 for MEM MODE. It should be noted that the setting range for the start address and the sequence length is reduced. No bits will be overwritten below the start address and one bit overwritten above the stop address.

In the 1M\*3 mode, the LEV-ATT channel can be used for level reduction. During recording, this signal then has to be fed into the BURST connector and is stored on the LEV-ATT and BURST channel (same contents on the two channels).

### 2.6.3.4 External Data Sources

Inputs DATA, CLOCK and BURST are available for the digital modulation with external data signals. The polarity of the modulation and the active clock edge can be selected in the menu. In the case of 4FSK and QPSK modulation, the CLOCK input can be switched over between bit clock and symbol clock. The BURST input controls the level reduction indicated in the menu under LEVEL ATTENUATION in the case of external modulation. What is to be considered is that the delays of modulation processing and level control are different. The delays of the different modulations are listed in table 2-5, radio network data. The delays of the level control are 2  $\mu$ s in switch-on and approx. 1  $\mu$ s in switch-off (cf. Fig. 2-38 as well).

Table 2-5 Radio network data

Network	Modulation	Filter	Bit rate	Delay (INT)	Delay (EXT)
GSM / PCN	GMSK	Gauss 0.3	270.833 kb/s	3.8 bit	2.8 bit
CDPD	GMSK	Gauss 0.5	19.2 kb/s	3.8 bit	2.8 bit
MC9	GMSK	Gauss 0.25	8 kb/s	3.8 bit	2.8 bit
DSRR	GMSK	Gauss 0.5	4 / 16 kb/s	3.8 bit	2.8 bit
MD24...MD192	GMSK	Gauss 0.3 / 0.5	2.4. to 19.2 kb/s	3.8 bit	2.8 bit
MOBITEX	GMSK	Gauss 0.3	8 kb/s	3.8 bit	2.8 bit
DECT	GFSK	Gauss 0.5	1152 kb/s	4.4 bit	3.4 bit
CT2	GFSK	Gauss 0.5	72 kb/s	4.4 bit	3.4 bit
CT3	GFSK	Gauss 0.5	640 kb/s	4.4 bit	3.4 bit
NADC	$\pi/4$ DQPSK	$\sqrt{\cos 0.35}$	48.6 kb/s	12 bit	12 bit
PDC	$\pi/4$ DQPSK	$\sqrt{\cos 0.5}$	42 kb/s	12 bit	12 bit
TFTS	$\pi/4$ DQPSK	$\sqrt{\cos 0.4}$	44.2 kb/s	12 bit	12 bit
APCO25	$\pi/4$ DQPSK	$\cos 0.2$	9.6 kb/s	12 bit	12 bit
TETRA	$\pi/4$ DQPSK	$\sqrt{\cos 0.35}$	36 kb/s	12 bit	12 bit
MSAT	QPSK	$\sqrt{\cos 0.6}$	6.75 kb/s	12 bit	12 bit
INMARSAT-M	OQPSK	$\sqrt{\cos 0.6}$	8 kb/s	12 bit	12 bit
ERMES	4FSK	Bessel 3.9 kHz	6.25 kb/s	3.3 bit	3.3 bit
APCO25	4FSK	$\cos 0.2$	9.6 kb/s	9.5 bit	9.5 bit
FLEX	4FSK	Bessel 3.9 kHz	3.2 / 6.4 kb/s	3.3 bit	3.3 bit
MODACOM	4FSK	$\sqrt{\cos 0.2}$	9.6 kb/s	9.5 bit	9.5 bit
CITYRUF	FSK	Gauss 2.73	512/1200/2400 b/s	3.6 bit	2.6 bit
POCSAG	FSK	Gauss 2.73	512/1200/2400 b/s	3.6 bit	2.6 bit
FLEX	FSK	Bessel 3.9 kHz	1.6/3.2 kb/s	1.5 bit	0.5 bit
POCSAG	FFSK	AF 1200/1800	1200 b/s	2.0 bit	1.0 bit

### 2.6.3.5 GMSK Modulation

Menu DIGITAL MOD-GMSK offers access to settings for GMSK modulation.

Menu selection: DIGITAL MOD - GMSK

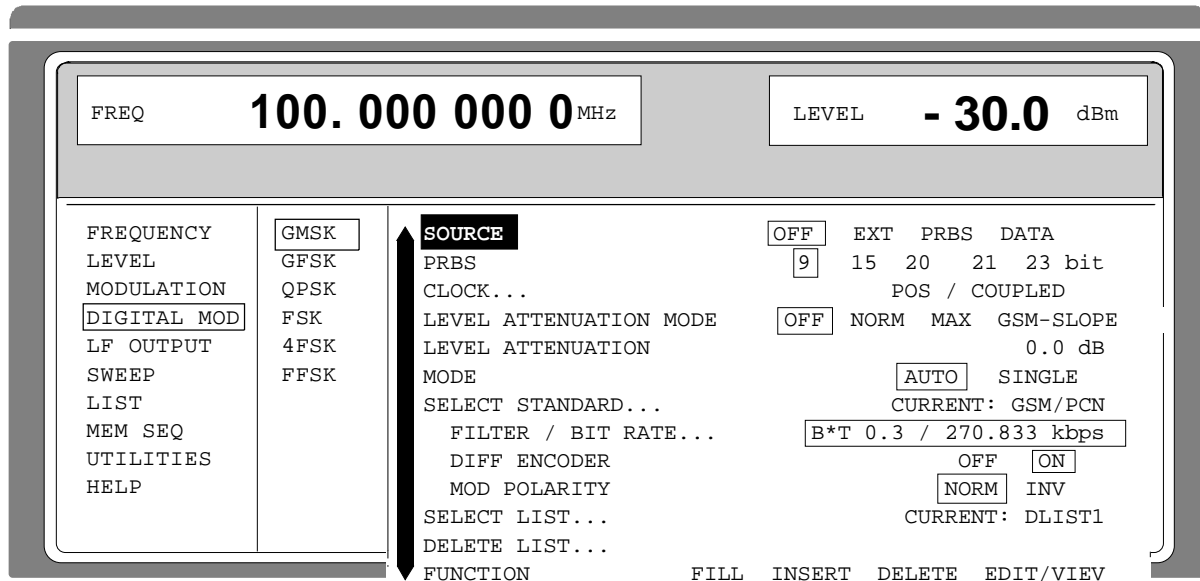

Fig. 2-41 Menu DIGITAL-MOD-GMSK (preset setting), fitted with option SME-B11, DM coder

#### SOURCE

Selection of the modulation source for GMSK.

OFF GMSK is switched off

EXT GMSK with external data signals

PRBS GMSK with pseudo random binary sequence

DATA GMSK with internally stored data sequence

IEC-bus command: SOUR:DM:TYPE:GMSK; SOUR EXT; STAT ON

#### PRBS

Selection of the Pseudo Random Binary Sequence.

IEC-bus command : SOUR:DM:PRBS 9

#### CLOCK...

Opens a window to set the clock parameters. The current settings are displayed (cf. Section "QPSK modulation").

#### LEVEL ATTENUATION MODE

Selection of the operating mode for level reduction

OFF The level reduction is switched off.

NORM The level reduction corresponds to the value entered in LEVEL ATTENUATION. The linear range extends to an attenuation of approx. 30 dB.

MAX The level reduction is set to a maximum attenuation of >80dB.

GSM SLOPE The rise and fall time of the level reduction correspond to GSM power ramping

IEC-bus command : SOUR:DM:DATA:ALEV:MODE NORM  
: SOUR:DM:GMSK:GSL ON

<b>LEVEL ATTENUATION</b>	Input value of the level reduction. The level reduction is internally controlled by the LEV-ATT bits in the data list or externally via connector BURST. A logic "1" in the data list causes a level reduction. IEC-bus command : SOUR:DM:DATA:ALEV 0dB
<b>MODE</b>	Selection of the operating mode for the DATA generator. AUTO The data are always repeated. SINGLE The data are sent once as soon as the run has been started using EXECUTE SINGLE MODE► IEC-bus command : TRIG:DM:SOUR AUTO
<b>SELECT STANDARD...</b>	Opens a window to select one of the standard GMSK modulations (see Table 2-5). By selecting a standard, the parameters indented below the line SELECT STANDARD are set according to standard. If the setting of a parameter is different from the standard, SELECT STANDARD... CURRENT:USER is displayed. IEC-bus command : SOUR:DM:GMSK:STAN GSM
<b>BITRATE /FILTER ...</b>	Selection of filtering BxT and bitrate. The following is to choose from: bitrate = 2.4 kb/s / BxT=0.3; 0.5      bitrate = 20.0 kb/s / BxT=0.5 bitrate=2.5 kb/s / BxT=0.5      bitrate = 24.0 kb/s / BxT=0.5 bitrate = 3.0 kb/s / BxT=0.5      bitrate = 28.8 kb/s / BxT=0.3 ; 0.5 bitrate = 3.6 kb/s / BxT=0.3 ;0.5      bitrate = 32.0 kb/s / BxT=0.3 ; 0.5 bitrate = 4.0 kb/s / BxT=0.3 ; 0.5      bitrate = 38.4 kb/s / BxT=0.3 ; 0.5 bitrate = 4.8 kb/s / BxT=0.3 ; 0.5      bitrate = 40.0 kb/s / BxT=0.5 bitrate = 5.0 kb/s / BxT=0.5      bitrate = 48.0 kb/s / BxT=0.5 bitrate = 6.0 kb/s / BxT=0.5      bitrate = 64.0 kb/s / BxT=0.3 ; 0.5 bitrate = 7.2 kb/s / BxT=0.3 ;0.5      bitrate=67.708kb/s/BxT=0.2;0.3;0.5 bitrate = 8 kb/s / BxT=0.25 ; 0.3 ;0.5      bitrate = 76.8 kb/s / BxT=0.3 ; 0.5 bitrate = 9.6 kb/s / BxT=0.3 ; 0.5      bitrate = 80.0 kb/s / BxT=0.5 bitrate = 10 kb/s / BxT=0.5      bitrate = 160 kb/s / BxT=0.5 bitrate = 12.0 kb/s / BxT=0.5      bitrate=70.833kb/s/BxT=0.2;0.3;0.5 bitrate = 14.4 kb/s / BxT=0.3 ; 0.5      bitrate = 512 kb/s / BxT=0.5 bitrate = 16.0 kb/s / BxT=0.3 ; 0.5      bitrate = 1000 kb/s BxT=0.4 bitrate=19.2 kb/s / BxT=0.3 ; 0.5 The current selection is displayed. IEC-bus commands : SOUR:DM:GMSK:FILT 0.3 ; BRAT 8kb/s
<b>DIFF ENCODER</b>	Switching on/off the GSM difference coding. IEC-bus command : SOUR:DM:GMSK:DCOD ON
<b>MOD POLARITY</b>	Selection of the polarity of the modulation excursion. NORM Polarity of the modulation as specified according to GSM. INV Polarity of the modulation is inverted. IEC-bus command : SOUR:DM:GMSK:POL NORM
<b>SELECT LIST...</b>	Selection of a list or generation of a new list (cf. Section 2.2.4, List Editor).
<b>DELETE LIST...</b>	Deletion of a list (cf. Section 2.2.4, List Editor).
<b>FUNCTION</b>	Selection of the editor function for processing the lists (cf. Section 2.2.4, List Editor).

### 2.6.3.6 GFSK Modulation

Menu DIGITAL MOD - GFSK offers access to settings for GFSK modulation.

Menu selection: DIGITAL MOD - GFSK

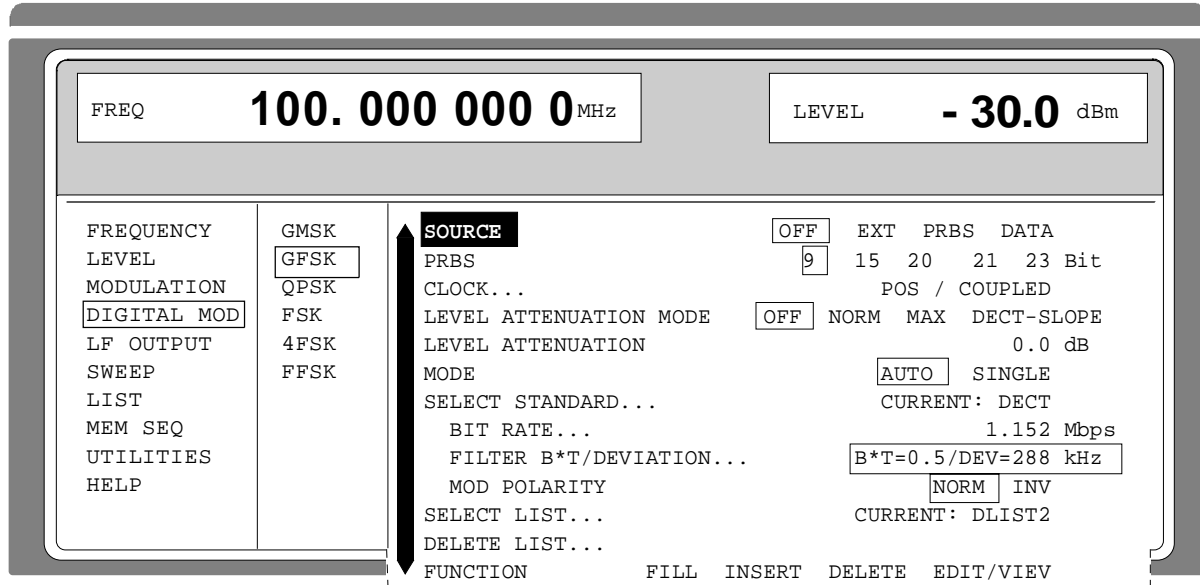

Fig. 2-42 Menu DIGITAL MOD-GFSK (preset setting), fitted with option SME-B11, DM coder

<b>SOURCE</b>	Selection of the modulation source for GFSK. IEC-bus command : SOUR:DM:TYPE GFSK; SOUR EXT; STAT ON
<b>PRBS</b>	Selection of the Pseudo Random Binary Sequence. IEC-bus command : SOUR:DM:PRBS 9
<b>CLOCK ...</b>	Opens a window to set the clock parameters. The current settings are displayed (cf. Section "QPSK modulation").
<b>LEVEL ATTENUATION MODE</b>	Selection of the operating mode for level reduction OFF The level reduction is switched off. NORM The level reduction corresponds to the value entered in LEVEL ATTENUATION. The linear range extends to an attenuation of approx. 30 dB. MAX The level reduction is set to a maximum attenuation of >80dB. DECT-SLOPE The rise and fall time of the level reduction are filtered. IEC-bus command : SOUR:DM:DATA:ALEV:MODE NORM
<b>LEVEL ATTENUATION</b>	Input value of the level reduction. The level reduction is internally controlled by the LEV ATT bits in the data list or externally via connector BURST. A logic "1" in the data list causes a level reduction. IEC-bus command : SOUR:DM:DATA:ALEV 0dB

<b>MODE</b>	<p>Selection of the operating mode for the DATA generator.</p> <p>AUTO      The data are always repeated.</p> <p>SINGLE     The data are sent once as soon as the run has been started using EXECUTE SINGLE MODE►</p> <p>IEC-bus command                    : TRIG:DM:SOUR AUTO</p>																
<b>SELECT STANDARD...</b>	<p>Opens a window to select one of the standard GFSK modulations (see Table 2-5). By selecting a standard, the parameters indented below the line SELECT STANDARD are set according to standard. If the setting of a parameter is different from the standard, SELECT STANDARD... CURRENT:USER is displayed.</p> <p>IEC-bus command                    : SOUR:DM:GFSK:STAN DECT</p>																
<b>BIT RATE</b>	<p>Input value of the bit rate for the selected standard.</p> <p>The specified ranges are 10...585 kb/s and 640 ...1170 kb/s.</p> <p>With settings BxT=0.5 / DEV=14.0 kHz and DEV=25.2 kHz the specified range is 0.05 to 90 kb/s.</p> <p>IEC-bus command                    : SOUR:DM:GFSK:BRAT 1152 kb/s</p>																
<b>FILTER / DEVIATION</b>	<p>Opens a window to select different settings with filtering BxT and with the deviation. The following is to choose from:</p> <table border="0"> <tr> <td>BxT=0.5 / DEV=14.0 kHz</td> <td>BxT=0.7 / DEV= 14.4 kHz</td> </tr> <tr> <td>BxT=0.5 / DEV=18.0 kHz</td> <td>BxT=0.5 / DEV= 20.0 kHz</td> </tr> <tr> <td>BxT=0.4 / DEV= 25.2 kHz</td> <td>BxT=0.5 / DEV=25.2 kHz</td> </tr> <tr> <td>BxT=0.5 / DEV=160 kHz</td> <td>BxT=0.5 / DEV=180 kHz</td> </tr> <tr> <td>BxT=0.5 / DEV=202 kHz</td> <td>BxT=0.5 / DEV=259 kHz</td> </tr> <tr> <td>BxT=0.4 / DEV=288 kHz</td> <td>BxT=0.5 / DEV=288 kHz</td> </tr> <tr> <td>BxT=0.6 / DEV=288 kHz</td> <td>BxT=0.5 / DEV=317 kHz</td> </tr> <tr> <td>BxT=0.5 / DEV=403 kHz</td> <td></td> </tr> </table> <p>The values currently set are displayed.</p> <p><b>Note:</b> In the RF range from 130 to 187 MHz, deviations &gt;200 kHz are not possible.</p> <p>IEC-bus command                    : SOUR:DM:GFSK:FILT 0.5; DEV 288kHz</p>	BxT=0.5 / DEV=14.0 kHz	BxT=0.7 / DEV= 14.4 kHz	BxT=0.5 / DEV=18.0 kHz	BxT=0.5 / DEV= 20.0 kHz	BxT=0.4 / DEV= 25.2 kHz	BxT=0.5 / DEV=25.2 kHz	BxT=0.5 / DEV=160 kHz	BxT=0.5 / DEV=180 kHz	BxT=0.5 / DEV=202 kHz	BxT=0.5 / DEV=259 kHz	BxT=0.4 / DEV=288 kHz	BxT=0.5 / DEV=288 kHz	BxT=0.6 / DEV=288 kHz	BxT=0.5 / DEV=317 kHz	BxT=0.5 / DEV=403 kHz	
BxT=0.5 / DEV=14.0 kHz	BxT=0.7 / DEV= 14.4 kHz																
BxT=0.5 / DEV=18.0 kHz	BxT=0.5 / DEV= 20.0 kHz																
BxT=0.4 / DEV= 25.2 kHz	BxT=0.5 / DEV=25.2 kHz																
BxT=0.5 / DEV=160 kHz	BxT=0.5 / DEV=180 kHz																
BxT=0.5 / DEV=202 kHz	BxT=0.5 / DEV=259 kHz																
BxT=0.4 / DEV=288 kHz	BxT=0.5 / DEV=288 kHz																
BxT=0.6 / DEV=288 kHz	BxT=0.5 / DEV=317 kHz																
BxT=0.5 / DEV=403 kHz																	
<b>MOD POLARITY</b>	<p>Selection of the polarity of the frequency modulation.</p> <p>NORM     Logic "1" generates a positive deviation.</p> <p>INV      Logic "1" generates a negative deviation.</p> <p>IEC-bus command                    : SOUR:DM:GFSK:POL NORM</p>																
<b>SELECT LIST...</b>	<p>Selection of a list or generation of a new list (cf. Section 2.2.4, List Editor).</p>																
<b>DELETE LIST...</b>	<p>Deletion of a list (cf. Section 2.2.4, List Editor).</p>																
<b>FUNCTION</b>	<p>Selection of the editor function to process the selected list (cf. Section 2.2.4, List Editor).</p>																



### 2.6.3.7 QPSK Modulation

Menu DIGITAL MOD - QPSK offers access to settings for QPSK modulation setting range of the bit rate is 1.00 to 24.3 kbps and 27.0 to 48.6 kbps. In range 1.00 to 24.3 kbps the nonharmonic suppression is reduced by aliasing products. The spurious products occur at the frequency spacing =  $15 \times$  bit rate. The spurious level is shown in the diagram.

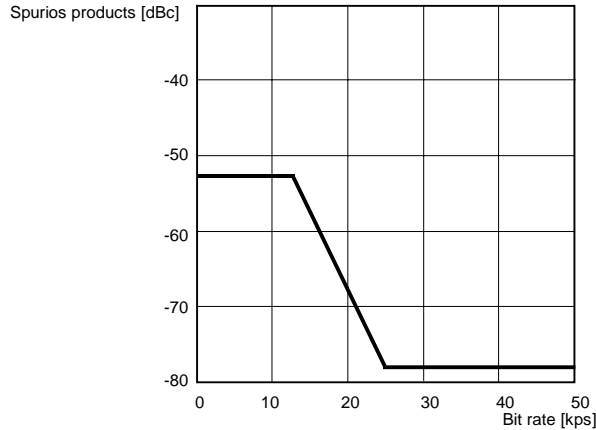

Menu selection DIGITAL MOD - QPSK

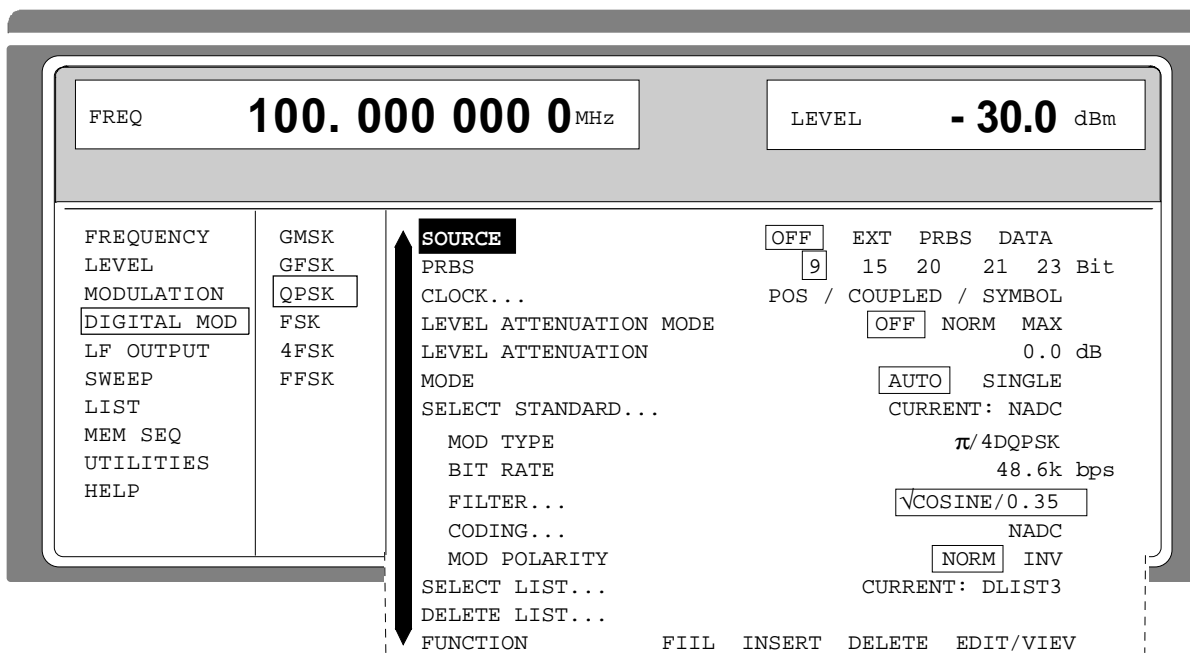

Fig. 2-43 Menu DIGITAL MOD - QPSK (preset setting), fitted with option SME-B11, DM coder

- SOURCE** Selection of the modulation source for QPSK.  
IEC-bus command :SOUR:DM:TYPE QPSK; SOUR EXT; STAT ON
- PRBS** Selection of the Pseudo Random Binary Sequence.  
IEC-bus command :SOUR:DM:PRBS 9

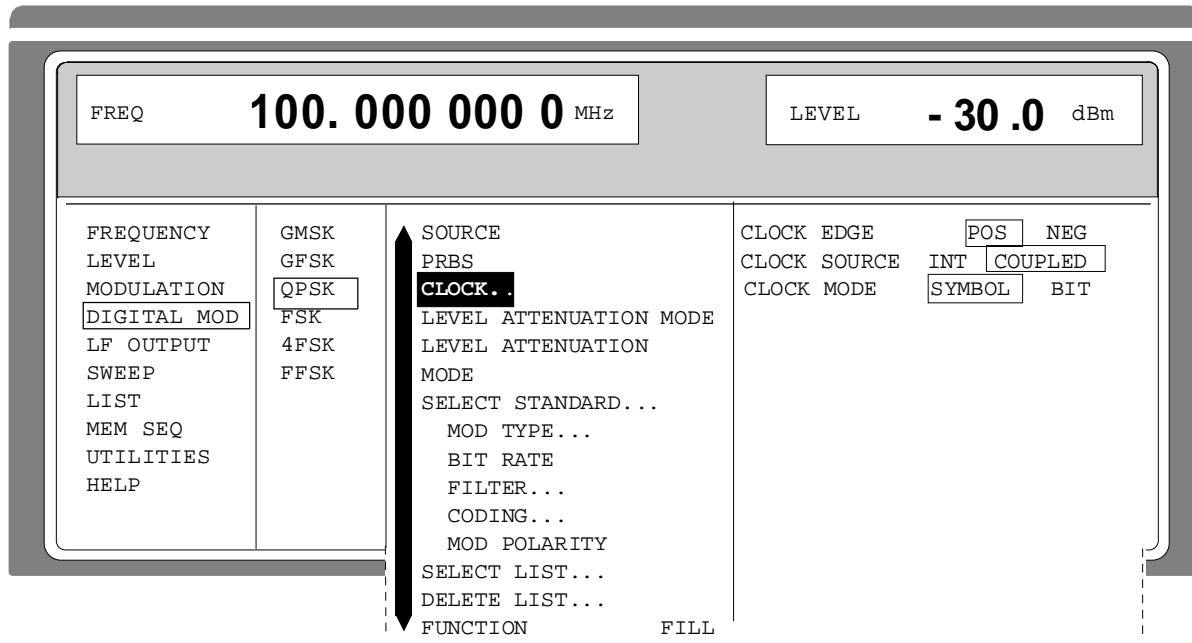

Fig. 2-44 Submenu DIGITAL-MOD-QPSK-CLOCK...(preset setting)

**CLOCK...**

Opens a window to set the clock parameters. The current settings are displayed.

**CLOCK EDGE** Selection of the active clock edge  
 POS The positive clock edge is active.  
 NEG The negative clock edge is active.  
 IEC-bus command :SOUR:DM:CLOC:POL NORM

**CLOCK SOURCE** Selection of the clock source  
 INT The internal clock generator is also used with an external data source. The CLOCK socket is switched to form an output  
 COUPLED The CLOCK input/output is switched in accordance with the DATA input/output.  
 IEC-bus command :SOUR:DM:CLOC:SOUR COUP

**CLOCK MODE** Selection of the clock pulse for the CLOCK input/output.  
 SYMBOL The CLOCK input/output is set to symbol clock pulse.  
 BIT The CLOCK input/output is set to bit clock.

**Note:** Using XMEM (option SMIQ-B12), requires CLOCK BIT to be set

IEC-bus command :SOUR:DM:CLOC:MODE SYMB

**LEVEL ATTENUATION MODE** Selection of the operating mode for level reduction  
 OFF The level reduction is switched off.  
 NORM The level reduction corresponds to the value entered in LEVEL ATTENUATION. The linear range extends to an attenuation of approx. 30 dB.  
 MAX The level reduction corresponds to the value entered in LEVEL ATTENUATION. The linear range extends to an attenuation of approx. 30 dB.

IEC-bus command :SOUR:DM:DATA:ALEV:MODE NORM

<b>LEVEL ATTENUATION</b>	Input value of the level reduction. The level reduction is internally controlled by the LEV ATT bits in the data list or externally via connector BURST. A logic "1" in the data list causes a level reduction. IEC-bus command : SOUR:DM:DATA:ALEV 0dB
<b>MODE</b>	Selection of the operating mode for the DATA generator. AUTO The data are always repeated. SINGLE The data are sent once as soon as the run has been started using EXECUTE SINGLE MODE► IEC-bus command : TRIG:DM:SOUR AUTO
<b>SELECT STANDARD...</b>	Opens a window to select one of the standard QPSK modulations (see Table 2-5). By selecting a standard, the parameters indented below the line SELECT STANDARD are set according to standard. If the setting of a parameter is different from the standard, SELECT STANDARD... CURRENT:USER is displayed. IEC-bus command : SOUR:DM:QPSK:STAN NADC
<b>MOD TYPE...</b>	Opens a window to select modulation type. The following is to choose of: QPSK, OQPSK, $\pi/4$ QPSK, $\pi/4$ DQPSK IEC-bus command : SOUR:DM:QPSK:TYPE QPSK
<b>BITRATE</b>	Input value of the bit rate. The specified ranges are 1 to 24.3 kbps and 27 to 48.6 kbps. In the range 1 to 24.3 kbps, the nonharmonic suppression is reduced (cf. diagram). IEC-bus command : SOUR:DM:QPSK:BRAT 48.6kb/s
<b>FILTER..</b>	Opens a window to select filtering (roll-off factor). The following is to choose from: OFF cos / 0,2 cos /0,35, $\sqrt{\text{cos}} /0,35,$ cos /0,4, $\sqrt{\text{cos}} /0,4,$ cos /0,5, $\sqrt{\text{cos}} /0,5,$ cos/0,6 $\sqrt{\text{cos}} /0,6.$  <i>Note: For modulation type OQPSK only <math>\sqrt{\text{cos}}/0.6</math> can be set.</i> IEC-bus command : SOUR:DM:QPSK:FILT SCOS,0.35
<b>CODING...</b>	Selection of difference coding. The following is to choose from: NADC, PDC, TETRA, APCO, TFTS, MSAT and INMARSAT IEC-bus command : SOUR:DM:QPSK:COD NADC
<b>MOD POLARITY</b>	Selection of the polarity of the modulation excursion. NORM Polarity of the modulation is specified according to standards. INV Polarity of the modulation is inverted. IEC-bus command : SOUR:DM:QPSK:POL NORM
<b>DELETE LIST...</b>	Deletion of a list (cf. Section 2.2.4, List Editor).
<b>FUNCTION</b>	Selection of the editor function to process the selected list (cf. Section 2.2.4, List Editor).

### 2.6.3.8 FSK Modulation

Menu DIGITAL MOD - FSK offers access to settings for FSK modulation. FSK modulation is possible with or without a filter. The filter can be switched off and allows free setting of the deviation. The maximum setting depends on the carrier frequency.

Carrier frequency	Maximum deviation
< 130 MHz	100 kHz
130 to 187.5 MHz	25 kHz
187.5 to 375 MHz	50 kHz
375 to 750 MHz	100 kHz
750 to 1500 MHz	200 kHz
1500 to 3000 MHz	400 kHz
3000 to 6000 MHz	800 kHz

If option SME-B11 is not installed, FSK modulation is only possible with an external source and without a filter. The menu indicates the lines SOURCE, DEVIATION and MOD POLARITY.

Menu selection DIGITAL MOD - FSK

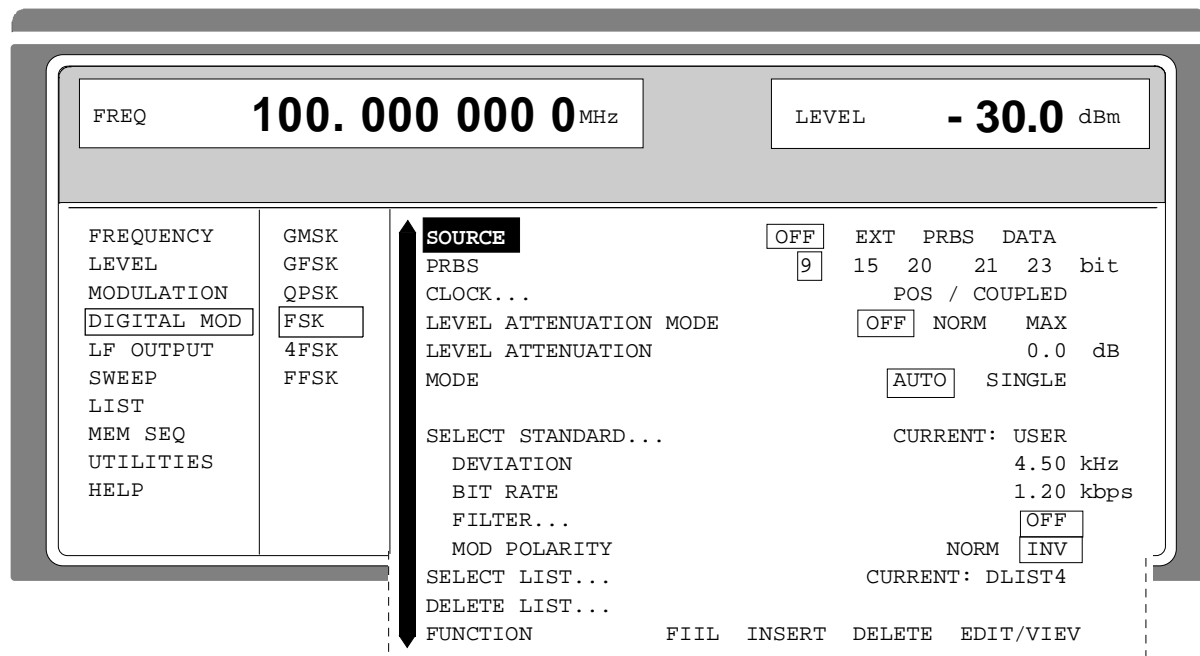

Fig. 2-45 Menu DIGITAL MOD - FSK (preset setting), fitted with option DM coder SME-B11

<b>SOURCE</b>	Selection of the modulation source for FSK. IEC-bus command :SOUR:DM:TYPE FSK; SOUR EXT; STAT ON
<b>PRBS</b>	Selection of the Pseudo Random Binary Sequence. IEC-bus command :SOUR:DM:PRBS 9
<b>CLOCK ...</b>	Opens a window to set the clock parameters. The current settings are displayed (cf. Section "QPSK modulation").
<b>LEVEL ATTENUATION MODE</b>	Selection of the operating mode for level reduction OFF The level reduction is switched off. NORM The level reduction corresponds to the value entered in LEVEL ATTENUATION. The linear range extends to an attenuation of approx. 30 dB. MAX The level reduction is set to a maximum attenuation of >80dB. IEC-bus command :SOUR:DM:DATA:ALEV:MODE NORM
<b>LEVEL ATTENUATION</b>	Input value of the level reduction. The level reduction is internally controlled by the LEV ATT bits in the data list or externally via connector BURST. A logic "1" in the data list causes a level reduction. IEC-bus command :SOUR:DM:DATA:ALEV 0dB
<b>MODE</b>	Selection of the operating mode for the DATA generator. AUTO The data are always repeated. SINGLE The data are sent once as soon as the run has been started using EXECUTE SINGLE MODE► IEC-bus command :SOUR:TRIG:DM:SOUR AUTO
<b>EXECUTE SINGLE MODE</b>	Starts a single servicing of the data. This action to be executed is only displayed and is only effective if MODE is set to SINGLE. IEC-bus commands :TRIG:DM:SOUR SING; :TRIG:DM
<b>SELECT STANDARD...</b>	Opens a window to select one of the standard FSK modulations (see Table 2-5). By selecting a standard, the parameters indented below the line SELECT STANDARD are set according to standard. If the setting of a parameter is different from the standard, SELECT STANDARD... CURRENT:USER is displayed. IEC-bus command :SOUR:DM:FSK:STAN POCS1200
<b>DEVIATION</b>	Input value of the deviation for FSK. If the FILTER is switched off, the deviation can be set in the range from 0 to 400 kHz. In this case, the maximum deviation depends on the carrier frequency and is limited to 20% of the analog FM deviation. IEC-bus command :SOUR:DM:FSK:DEV 4.5kHz
<b>BIT RATE</b>	Input value of the bit rate for FSK. Setting range: FILTER OFF: 0.05 to 1900 kbps FILTER switched on: 0.05 to. 90 kbps; resolution: 3-digit IEC-bus command :SOUR:DM:FSK:BRAT 1200b/s

<b>FILTER...</b>	<p>Opens a window to select the filters. The following filters can be selected:</p> <p>OFF</p> <p>BESSEL BxT=1.22 (corresponds to a bandwidth of 3.9 kHz at 3.2 kbps)</p> <p>BESSEL BxT=2.44 (corresponds to a bandwidth of 3.9 kHz at 1.6 kbps)</p> <p>GAUSS BxT=2.73 (corresponds to a rise time 250 µs at 512 bps)</p> <p>Due to digital filtering, a change of the bit rate influences the cut-off frequency of the filter. That is why BxT (bandwidthxsymbol duration) is indicated instead of the cut-off frequency which is specified according to the standard. The cut-off frequency of the filter is calculated as follows: Cut-off frequency = BxT value x symbol rate</p> <p>IEC-bus command : SOUR:DM:FSK:FILT BESS, 1.22</p>
<b>MOD POLARITY</b>	<p>Selection of the polarity of the frequency modulation.</p> <p>NORM Logic "1" generates a positive deviation.</p> <p>INV Logic "1" generates a negative deviation.</p> <p>IEC-bus command : SOUR:DM:FSK:POL NORM</p>
<b>SELECT LIST...</b>	Selection of a list or generation of a new list (cf. Section 2.2.4, List Editor).
<b>DELETE LIST...</b>	Deletion of a list (cf. Section 2.2.4, List Editor).
<b>FUNCTION</b>	Deletion of a list (cf. Section 2.2.4, List Editor).

### 2.6.3.9 4FSK Modulation

Menu DIGITAL MOD - 4FSK offers access to settings for 4FSK modulation. The maximum setting depends on the carrier frequency:

Carrier frequency	Maximum deviation
< 130 MHz	100 kHz
130 to 187.5 MHz	25 kHz
187.5 to 375 MHz	50 kHz
375 to 750 MHz	100 kHz
750 to 1500 MHz	200 kHz
1500 to 3000 MHz	400 kHz
3000 to 6000 MHz	800 kHz

Menu selection DIGITAL MOD - 4FSK

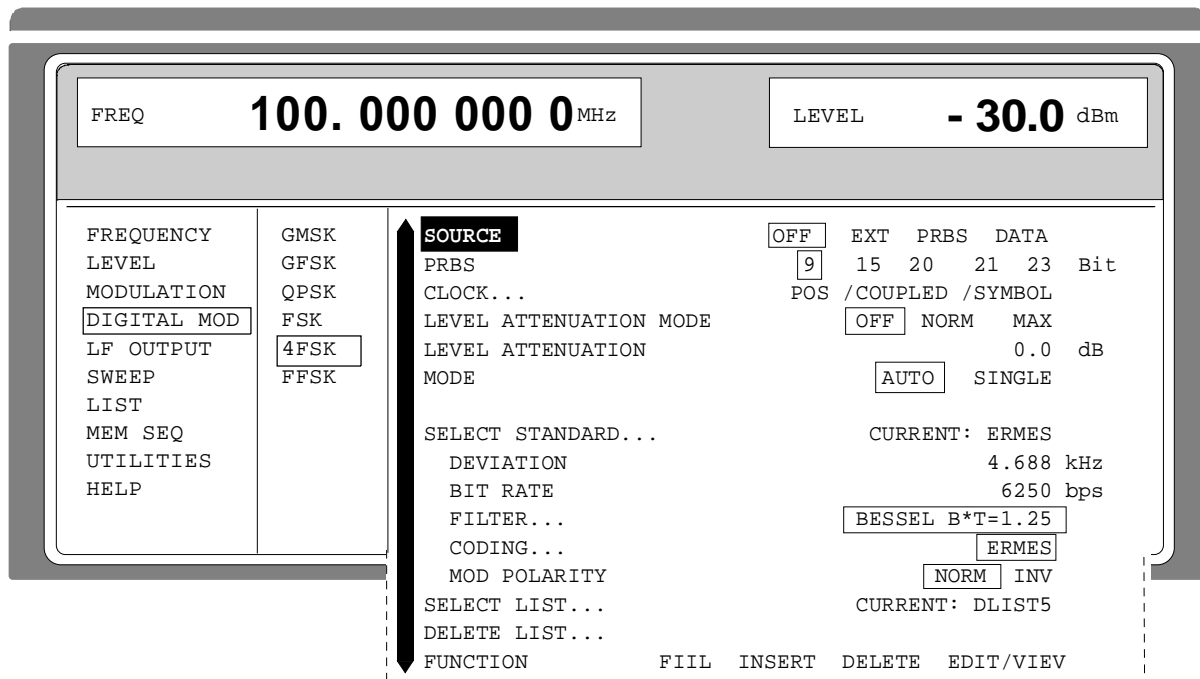

Fig. 2-46 Menu DIGITAL MOD - 4FSK (preset setting), fitted with option SM-B11, DM coder

<b>SOURCE</b>	Selection of the modulation source for 4FSK. IEC-bus command : SOUR:DM:TYPE FSK4; SOUR EXT; STAT ON
<b>PRBS</b>	Selection of the Pseudo Random Binary Sequence.. IEC-bus command : SOUR:DM:PRBS 9
<b>CLOCK ...</b>	Opens a window to set the clock parameters. The current settings are displayed (cf. Section "QPSK modulation")
<b>LEVEL ATTENUATION MODE</b>	Selection of the operating mode for level reduction OFF The level reduction is switched off. NORM The level reduction corresponds to the value entered in LEVEL ATTENUATION. The linear range extends to an attenuation of approx. 30 dB. MAX The level reduction is set to a maximum attenuation of >80dB. IEC-bus command : SOUR:DM:DATA:ALEV:MODE NORM
<b>LEVEL ATTENUATION</b>	Input value of the level reduction. The level reduction is internally controlled by the LEV ATT bits in the data list or externally via connector BURST. A logic "1" in the data list causes a level reduction. IEC-bus command : SOUR:DM:DATA:ALEV 0dB
<b>MODE</b>	Selection of the operating mode for the DATA generator. AUTO The data are always repeated. SINGLE The data are sent once as soon as the run has been started using EXECUTE SINGLE MODE ►. IEC-bus command : TRIG:DM:SOUR AUTO
<b>EXECUTE SINGLE MODE →</b>	Starts a single servicing of the data. These action to be executed is only displayed and is only effective if MODE is set to SINGLE. IEC-bus commands : TRIG:DM:SOUR SING; : TRIG:DM
<b>SELECT STANDARD...</b>	Opens a window to select one of the standard 4FSK modulations (see Table 2-5). By selecting a standard, the parameters indented below the line SELECT STANDARD are set according to standard. If the setting of a parameter is different from the standard, SELECT STANDARD... CURRENT:USER is displayed. IEC-bus command : SOUR:DM:FSK4:STAN ERM
<b>DEVIATION</b>	Input value of the deviation for 4FSK. The maximum setting depends on the carrier frequency and is limited to 20% of the analog FM deviation. IEC-bus command : SOUR:DM:FSK4:DEV 4.6875 kHz
<b>BIT RATE</b>	Input value of the bit rate for 4FSK. Setting range: 1 to 24.3 kbps and 27 to 48.6 kbps. IEC-bus command : SOUR:DM:FSK4:BRAT 6250b/s





### 2.6.3.10 FFSK Modulation

Menu DIGITAL MOD - FFSK offers access to settings for FFSK modulation.

Menu selection: DIGITAL MOD - FFSK

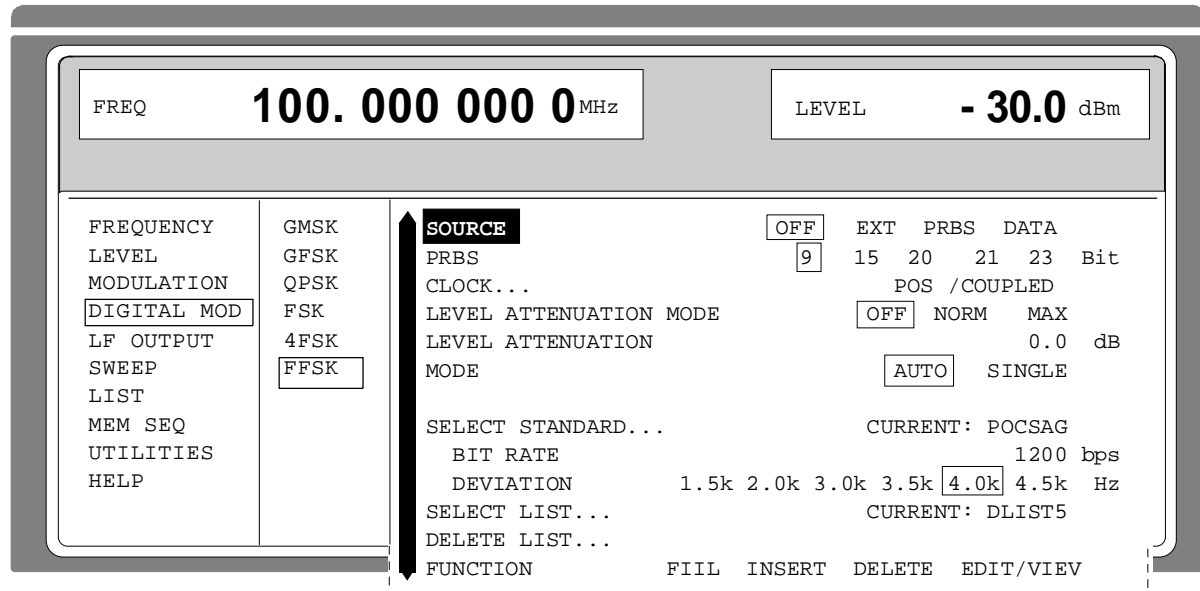

Fig. 2-47 Menu DIGITAL MOD - FFSK (preset setting), fitted with option SME-B11, DM-coder

- SOURCE** Selection of the modulation source FFSK.  
IEC-bus command : SOUR:DM:TYPE FFSK; SOUR EXT; STAT ON
- PRBS** Selection of the Pseudo Random Binary Sequence.  
IEC-bus command : SOUR:DM:PRBS 9
- CLOCK ...** Opens a window to set the clock parameters. The current settings are displayed (cf. Section "QPSK modulation").
- LEVEL ATTENUATION MODE** Selection of the operating mode for level reduction
  - OFF The level reduction is switched off.
  - NORM The level reduction corresponds to the value entered in LEVEL ATTENUATION. The linear range extends to an attenuation of approx. 30 dB.
  - MAX The level reduction is set to a maximum attenuation of >80dB.
 IEC-bus command : SOUR:DM:DATA:ALEV:MODE NORM
- LEVEL ATTENUATION** Input value of the level reduction. The level reduction is internally controlled by the LEV ATT bits in the data list or externally via connector BURST. A logic "1" in the data list causes a level reduction.  
IEC-bus command : SOUR:DM:DATA:ALEV 0dB

<b>MODE</b>	<p>Selection of the operating mode for the DATA generator.</p> <p>AUTO The data are always repeated.</p> <p>SINGLE The data are sent once as soon as the run has been started using EXECUTE SINGLE MODE ►</p> <p>IEC-bus command :TRIG:DM:SOUR AUTO</p>
<b>EXECUTE SINGLE MODE →</b>	<p>Starts a single servicing of the data. This action to be executed is only indicated and is only effective if MODE is set to SINGLE.</p> <p>IEC-bus commands :TRIG:DM:SOUR SING; :TRIG:DM</p>
<b>SELECT STANDARD...</b>	<p>Opens a window to select the standard FFSK modulation (see Table 2-5). By selecting a standard, the parameters indented below the line SELECT STANDARD are set according to standard. If the setting of a parameter is different from the standard, SELECT STANDARD... CURRENT:USER is displayed.</p> <p>IEC-bus command :SOUR:DM:FFSK:STAN POCS</p>
<b>BIT RATE</b>	<p>Input value of the bit rate for the internal modulation signals.</p> <p>Setting range: 0.05 to 90 kbps..</p> <p>IEC-bus command :SOUR:DM:FFSK:BRAT 1200 b/s</p>
<b>DEVIATION</b>	<p>Selection of the deviation for FFSK. The following is to choose from: 1.5 kHz, 2 kHz, 3 kHz, 3.5 kHz, 4 kHz and 4.5 kHz</p> <p>IEC-bus command :SOUR:DM:FFSK:DEV 4kHz</p>
<b>SELECT LIST...</b>	<p>Selection of a list or generation of a new list (cf. Section 2.2.4, List Editor).</p>
<b>DELETE LIST...</b>	<p>Deletion of a list (cf. Section 2.2.4, List Editor).</p>
<b>FUNCTION</b>	<p>Selection of the editor function to process the list selected (cf. Section 2.2.4, List Editor).</p>

### 2.6.3.11 Radiocommunication Service ERMES

ERMES is a radiocommunication method permitting Europe-wide paging. If fitted with options SME-B11, DM coder, and SME-B12, memory extension, the SME generates ERMES call signals conforming to standard. All parameters and the message to be transmitted can be freely selected.

**Note:** Switching on ERMES automatically switches off all other DM modulations.

Menu selection: DIGITAL MOD - ERMES

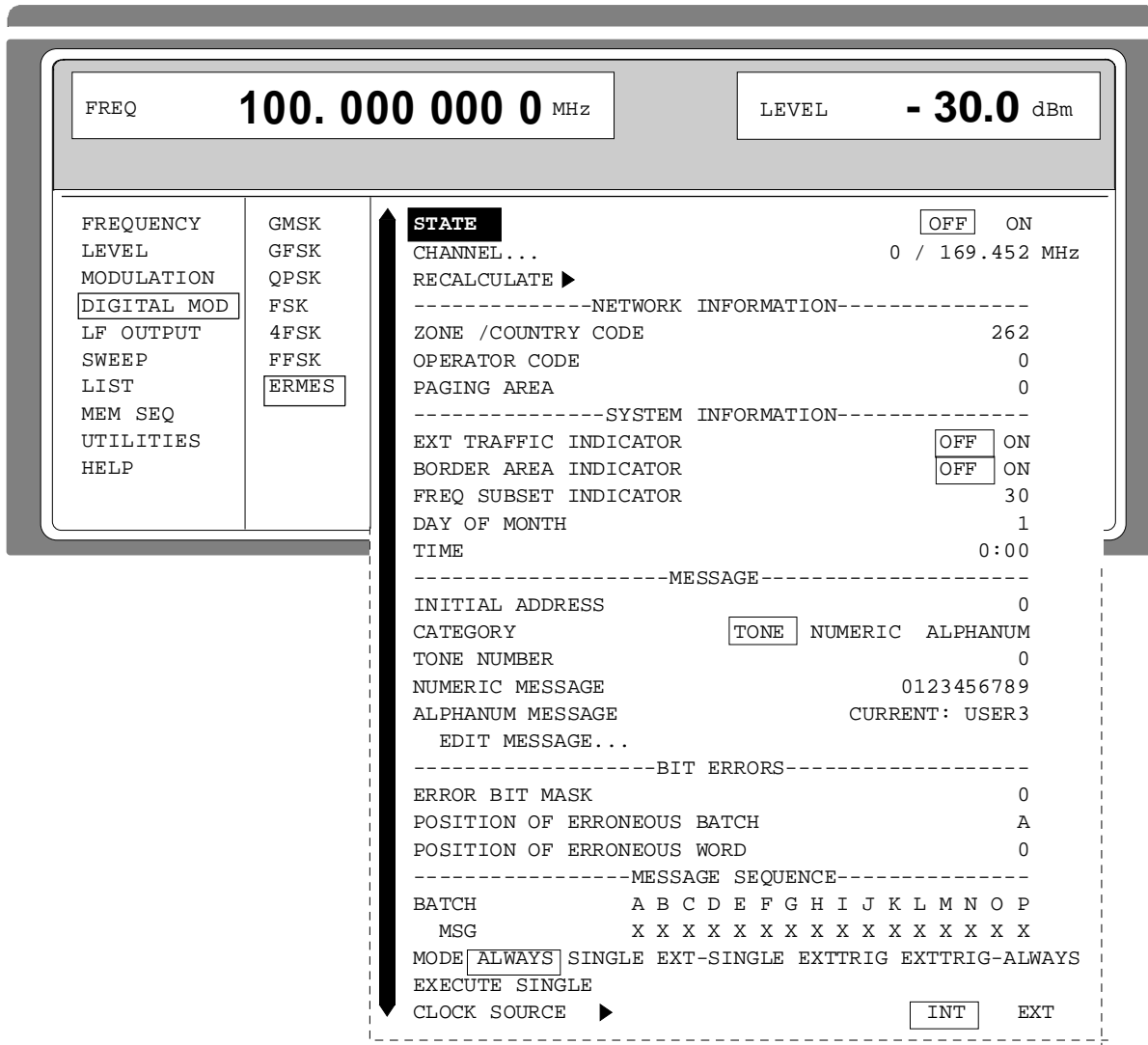

Fig. 2-48 Menu DIGITAL MOD - ERMES (preset setting), fitted with option SME-B11, DM coder and option SM-B12, memory extension

<b>STATE</b>	<p>ON Switching on ERMES. The RF frequency is set to the value determined by the selection of CHANNEL. The status line indicates the word ERMES, the batch, the number of subsequence, and the type of data sent. "MSG" indicates message data, "- -" indicates fill data.</p> <p>With every change from STATE OFF to STATE ON, the data for the memory extension are recalculated and written into list "XMEM". Every change of one of the ERMES parameters, except for MESSAGE SEQUENCE MODE, requires the data to be recalculated. During STATE ON, every change of the parameters thus generates a warning "ERMES settings and output signal mismatch". The data can be recalculated either by switching over to STATE OFF / STATE ON or by triggering action RECALCULATE ➤.</p> <p>OFF Switching off ERMES</p> <p>IEC-bus command : SOUR:ERM:STAT ON</p>																
<b>CHANNEL...</b>	<p>Opens a window to select the RF channel used. 16 channels with the appropriate frequencies can be selected:</p> <table border="0"> <tr> <td>Channel 0: 169,425 MHz</td> <td>Channel 8: 169,625 MHz</td> </tr> <tr> <td>Channel 1: 169,450 MHz</td> <td>Channel 9: 169,650 MHz</td> </tr> <tr> <td>Channel 2: 169,475 MHz</td> <td>Channel 10: 169,675 MHz</td> </tr> <tr> <td>Channel 3: 169,500 MHz</td> <td>Channel 11: 169,700 MHz</td> </tr> <tr> <td>Channel 4: 169,525 MHz</td> <td>Channel 12: 169,725 MHz</td> </tr> <tr> <td>Channel 5: 169,550 MHz</td> <td>Channel 13: 169,750 MHz</td> </tr> <tr> <td>Channel 6: 169,575 MHz</td> <td>Channel 14: 169,775 MHz</td> </tr> <tr> <td>Channel 7: 169,600 MHz</td> <td>Channel 15: 169,800 MHz</td> </tr> </table> <p>The selection of the channel also influences the structure of the ERMES data. Thus the channel cannot be changed by readjusting the frequency in the FREQUENCY menu or via the [FREQ] key.</p> <p>Readjusting the RF output frequency by means of the [FREQ] key or in the FREQUENCY menu is possible, however, message "ERMES channel / Frequency mismatch" is displayed.</p> <p>IEC-bus command : SOUR:ERM:CHAN 1</p>	Channel 0: 169,425 MHz	Channel 8: 169,625 MHz	Channel 1: 169,450 MHz	Channel 9: 169,650 MHz	Channel 2: 169,475 MHz	Channel 10: 169,675 MHz	Channel 3: 169,500 MHz	Channel 11: 169,700 MHz	Channel 4: 169,525 MHz	Channel 12: 169,725 MHz	Channel 5: 169,550 MHz	Channel 13: 169,750 MHz	Channel 6: 169,575 MHz	Channel 14: 169,775 MHz	Channel 7: 169,600 MHz	Channel 15: 169,800 MHz
Channel 0: 169,425 MHz	Channel 8: 169,625 MHz																
Channel 1: 169,450 MHz	Channel 9: 169,650 MHz																
Channel 2: 169,475 MHz	Channel 10: 169,675 MHz																
Channel 3: 169,500 MHz	Channel 11: 169,700 MHz																
Channel 4: 169,525 MHz	Channel 12: 169,725 MHz																
Channel 5: 169,550 MHz	Channel 13: 169,750 MHz																
Channel 6: 169,575 MHz	Channel 14: 169,775 MHz																
Channel 7: 169,600 MHz	Channel 15: 169,800 MHz																
<b>RECALCULATE ➔</b>	<p>Triggers a recalculation of the data for the "XMEM" list. This action must be triggered after every change of the parameters, except for MESSAGE SEQUENCE MODE.</p> <p>IEC-bus command : SOUR:ERM:STAT OFF; STAT ON</p>																
<b>--- NETWORK INFORMATION ---</b>	<p>The parameters of the network information set the data denoting the network the SME simulates in greater detail. These data are included in every message (cf. ERMES standard).</p>																
<b>ZONE / COUNTRY CODE</b>	<p>Input value of the zone and country code. Germany has the value 262.</p> <p>IEC-bus command : SOUR:ERM:NINF:ZCO 262</p>																

<b>OPERATOR CODE</b>	Input value of the code of the network operator. IEC-bus command : SOUR:ERM:NINF:OPER 7
<b>PAGING AREA</b>	Input value of the paging area. IEC-bus command : SOUR:ERM:NINF:PA 4
<b>--- SYSTEM INFORMATION ---</b>	The parameters of the system information set the data of the transmitting system. These data are included in every message (cf. ERMES standard).
<b>EXT TRAFFIC INDICATOR</b>	Input value of the External Traffic Indicator Bit. IEC-bus command : SOUR:ERM:SI:ETI ON
<b>BORDER AREA INDICATOR</b>	Input value of the Border Area Indicator Bit. IEC-bus command : SOUR:ERM:SI:BAI ON
<b>FREQ SUBSET INDICATOR</b>	Input value of the Frequency Subset Indicator. One-channel networks have an FSI of 30 according to ERMES standard. IEC-bus command : SOUR:ERM:SI:FSI 30
<b>DAY OF MONTH</b>	Input value of the date (day of month). IEC-bus command : SOUR:ERM:SI:DOM 24
<b>TIME</b>	Input value of the time. IEC-bus command : SOUR:ERM:SI:TIME 12,59
<b>--- MESSAGE ---</b>	The parameters of this section set the destination address and determine the message data.
<b>INITIAL ADDRESS</b>	Input value of the address of the pager. Every receiver has an own, nonrecurring address. IEC-bus command : SOUR:ERM:MESS:IA 0
<b>CATEGORY</b>	Selection of the message category. TONE Tone-only message NUMERIC Numeric message ALPHANUM Alphanumeric message IEC-bus command : SOUR:ERM:MESS:CAT TONE
<b>TONE NUMBER</b>	Input value of the tone transmitted with message category TONE. 16 tones (8 normal, 8 urgent) are available. IEC-bus command : SOUR:ERM:MESS:TONE 1
<b>NUMERIC MESSAGE</b>	Input of the character string for a numeric message. The SME maximally provides 16 digits. In addition to the 10 digits "0" to "9", the signs forward slash "/", upper-case letter "U", hyphen "-", period ".", percent "%" and blank can be used. IEC-bus command : SOUR:ERM:MESS:NUM "12% 12-17"

<b>ALPHANUM MESSAGE</b>	<p>Opens a window to select an alphanumeric message and to create a new one. The following is available:</p> <p>FOX            "The quick brown fox jumps over the lazy dog"</p> <p>ALPHA         "ABCD..." (complete ERMES character string)</p> <p>LONG          Message completely filling a batch</p> <p>USER1 to 3    Three messages which can freely be edited by means of command EDIT MESSAGE..</p> <p>IEC-bus command                    : SOUR:ERM:MESS:ALPH "FOX"</p>
<b>EDIT MESSAGE</b>	<p>Opens a window to edit one of the alphanumeric messages USER1 to USER3. The message to be processed must be selected using ALPHANUM MESSAGE.</p> <p>IEC-bus command                    : SOUR:ERM:MESS:ALPH:DATA "Test"</p>
<b>--- BIT ERRORS ---</b>	<p>The SME offers the possibility of providing a 30-bit word of the message transmitted with bit errors for test purposes. The parameters of this section determine the faulty bits and their position.</p>
<b>ERROR BIT MASK</b>	<p>Input of the faulty bits into a 30-bit field. The decimal number transmitted (0 to 1073741823) is converted into a 30-bit binary number internally and thus determines the 30 bits. These bits are XORed with the word of the message to be corrupted and thus determine which bits of this word are transmitted correctly or wrongly.</p> <p>IEC-bus command                    : SOUR:ERM:ERR:MASK 0</p>
<b>POSITION OF ERRONEOUS BATCH</b>	<p>Input value of the batch in which the faulty word is to be.</p> <p>IEC-bus command                    : SOUR:ERM:ERR:BATC A</p>
<b>POSITION OF ERRONEOUS WORD</b>	<p>Input value of the faulty word. 0 to 153 are valid values (0 to 189 for a long batch)</p> <p>IEC-bus command                    : SOUR:ERM:ERR:WORD 1</p>
<b>--- MESSAGE SEQUENCE ---</b>	<p>The SME always sends complete cycles from five subsequences. Two types of subsequence are generated. In the message subsequence, fill data and message data are mixed, the fill subsequence only contains fill data. The message subsequences of a cycle only differ in the subsequence number contained, they cannot be configured differently. I.e., the settings under BATCH are valid for all message subsequences of a cycle.</p> <p>The fill subsequences cannot be configured, the subsequences of a cycle also only differ in the subsequence number contained.</p> <p>The parameters of this section determine how the message subsequence is structured and when which subsequence is sent.</p>
<b>BATCH</b>	<p>For each of batches A to P of the message subsequence, a determination is possible whether it contains message data (an X under the letter) or fill data (a blank under the letter). Operation is analog to the variation of a number with the rotary knob, however, the characters are restricted to 2 there.</p> <p>IEC-bus command                    : SOUR:ERM:SEQ:DBAT A, B, G,H</p>

<b>MODE</b>	<p>Selection of the message and fill subsequence.</p> <p><b>ALWAYS</b> The message subsequence is output continuously. IEC-bus command :TRIG:DM:SOUR AUTO</p> <p><b>SINGLE</b> The filler subsequence is output. With the trigger pulse, switchover to message subsequence is effected for 12 seconds. IEC-bus command :TRIG:DM:SOUR SING :SOUR:ERM:TACT MESS</p> <p><b>EXT</b> The filler subsequence is output. With the trigger pulse from the external trigger female connector, switchover to message subsequence is effected for 12 seconds. IEC-bus command :TRIG:DM:SOUR EXT :SOUR:ERM:TACT MESS</p> <p><b>EXTTRIG</b> The SME only starts with the generation of the FLEX signal after recognition of a trigger pulse at the trigger input connector. After recognition of this signal, a message subsequence (length: 12 seconds) is output. IEC-bus command: :TRIG:DM:SOUR EXT; :SOUR:ERM:TACT ONCE</p> <p><b>EXTTRIG-ALWAYS</b> The units waits for a signal edge at the trigger connector. After recognition of this edge, the unit behaves as described under setting ALWAYS. IEC-bus command :TRIG:DM:SOUR EXT :SOUR:ERM:TACT STAR</p>
<b>EXECUTE SINGLE →</b>	<p>Starts the output of a message subsequence (length: 12 seconds). Afterwards, fill subsequences are sent again. This action to be executed is only displayed and is only effective if MODE SINGLE is selected. IEC-bus command *TRG</p>
<b>CLOCK SOURCE</b>	<p>Selection of the clock source. This setting is also valid for FLEX, REFLEX and POCSAG but not for the other digital modulations.</p> <p><b>INT</b> The clock required for signal generation is generated internally and can be tapped at the CLOCK connector.</p> <p><b>EXT</b> The signal applied to the CLOCK connector is used as the clock signal.</p> <p><b>Note:</b> For all bit rates, i.e. for 1600 bps and 3200 bps, a symbol clock rate of 3200 Hz is always used. This applies to both the output (CLOCK SOURCE INT) and the input (CLOCK SOURCE EXT) of the clock.</p> <p>IEC-bus command :SOUR:SOUR:DM:COMP:CLOC:SOUR INT</p>



### 2.6.3.12 Radiocommunication Service FLEX

Like ERMES, FLEX is a radiocommunication service that makes for convenient paging. When equipped with the SME-B41 (FLEX), SME-B11 (DM coder) and SME B12 (DM memory extension) options, the SME generates call signals complying to the FLEX or FLEX-TD standard. All essential parameters and the message to be transmitted are freely selectable.

FLEX settings can be accessed via the DIGITAL-MOD- FLEX menu:

FREQ		100. 000 000 0 MHz		LEVEL		- 30.0 dBm	
FREQUENCY	GMSK	<b>STATE</b>		<input type="checkbox"/> OFF	ON		
LEVEL	GFSK	MODULATION		<input type="checkbox"/> 1600-2FSK			
MODULATION	QPSK	DEVIATION			4.8 kHz		
<b>DIGITAL MOD</b>	FSK	-----SYSTEM INFORMATION-----					
LF OUTPUT	4FSK	SYSTEM COLLAPSE VALUE			4		
SWEEP	FFSK	FRAME OFFSET			1		
LIST	ERMES	ROAMING		<input type="checkbox"/> OFF	NID SSID ALL		
MEM SEQ	<b>FLEX</b>	SSID					
UTILITIES		LOCAL ID			0		
HELP		COVERAGE ZONE			0		
		COUNTRY CODE			262		
		SSID TMF			15		
		NID					
		NETWORK ADDRESS			2058240		
		MULTIPLIER			1		
		SERVICE AREA			0		
		NID TMF			15		
		DATE			1994/01/01		
		TIME			12:00		
		-----MESSAGE-----					
		CAPCODE			A0000001		
		AUTO ADJUST		NONE PHASE FRAME	<input type="checkbox"/> BOTH		
		PHASE			<input type="checkbox"/> A		
		CATEGORY			<input type="checkbox"/> TONE		
		REPEATS			0		
		TONE NUMBER			0		
		NUMERIC/SNUMERIC MESSAGE...			0123456789		
		ALPHANUM MESSAGE			CURRENT: USER3		
		EDIT MESSAGE					
		SECURE MESSAGE			CURRENT: USER3		
		TYPE		<input type="checkbox"/> ASCII	BIN	USER	RESERVED
		BINARY MESSAGE			CURRENT: USER1		
		EDIT MESSAGE					
		DISPLAY DIRECTION			<input type="checkbox"/> LEFT	<input type="checkbox"/> RIGHT	
		BLOCKING LENGTH			1		
		MESSAGE NUMBERING			<input type="checkbox"/> OFF	ON	
		MAIL DROP FLAG			<input type="checkbox"/> OFF	ON	
		-----BIT ERRORS-----					
		ERROR BIT MASK			0		
		POSITION OF ERRONEOUS WORD			0		
		-----MESSAGE GENERATION-----					
		START IN CYCLE			0		
		START IN FRAME			0		
		FRAME CONTENTS...					
		RECALCULATE			▶		
		MODE		<input type="checkbox"/> ALWAYS	SINGLE	EXT-SINGLE	EXTTRIG
		EXECUTE SINGLE			▶		
		CLOCK SOURCE			<input type="checkbox"/> INT	EXT	

Fig. 2-49 Menu DIGITAL MOD - FLEX, options SME-B41, SME-B11, SM-B12

<b>STATE</b>	<p>ON Switch on of FLEX. The RF frequency has to be set to the desired value by means of key [FREQ]. The status line displays the word FLEX as well as the cycle and frame number and the type of output data:</p> <p>SEC secure message INST instruction to SSID subscriber TONE tone-only message NUM numeric message SNUM special numeric message ALPH alphanumeric message BIN binary/hexadecimal message RSYN emergency resync ---- FLEX frame without message OTH frame without FLEX structures</p> <p>If REPEATS is larger than 0 (i.e. FLEX-TD active), only the first character is displayed for each phase (for SNUM a P is displayed).</p> <p><i>A switchover from STATE OFF to STATE ON results in a recalculation of the memory extension data and their entry into the list "XMEM". Changing FLEX parameters except for MESSAGE GENERATION MODE requires a recalculation of data. With radiocommunication service FLEX activated (STATE ON), every parameter change generates a warning "FLEX setting and output signal mismatch". The recalculation of data can either be effected by switchover from STATE OFF / STATE ON or by triggering RECALCULATE ►.</i></p> <p>OFF Switch off of FLEX</p> <p>IEC -bus command: :SOUR:FLEX:STAT OFF</p>
<b>MODULATION</b>	<p>Selection of used bit rate and modulation. Four modulations are available: 1600bps/2FSK 3200bps/2FSK 3200bps/4FSK 6400bps/4FSK Basic setting after *RST: 1600-2FSK</p> <p>IEC-bus command :SOUR:FLEX:MOD 1600,FSK2</p>
<b>DEVIATION</b>	<p>Input value of frequency deviation of modulation. The deviation specifies the spacing from the carrier to the two further placed symbols in 4FSK. The FLEX standard specifies 4800 Hz for this value which may be varied for testing. Basic setting after *RST: 4800Hz.</p> <p>IEC-bus command :SOUR:FLEX:DEV 4.8kHz</p>
<b>--- SYSTEM INFORMATION ---</b>	<p>The system information parameters are used for setting the data of the sending system. These data are sent to the pager (see FLEX standard).</p>
<b>SYSTEM COLLAPSE VALUE</b>	<p>Input value of number of bits (0 to 7) which the pager uses to compare its home frame number with the received frame number The value 7 signifies that the pager only accepts messages in one of the 128 frames (provided its pager collapse value is not below 7). With the value 0 the pager receives messages in any frame. Basic setting after *RST: 4.</p> <p>IEC-bus command :SOUR:FLEX:SI:COLL 4</p>

<b>FRAME OFFSET</b>	Input value of the frame offsets. IEC-bus command:       : SOUR:FLEX:SINF:FOFF 0
<b>ROAMING</b>	<p>Activating/Deactivating the generation of roaming information in the telegram sent.</p> <p>OFF   None; the roaming bits in the frame information word have the value 0.</p> <p>SSID  BIW000 for all frames, each in one phase.           BIW111 in the first four frames, each in one phase.</p> <p>NID   NID in all frames which comply with the formula specified in the FLEX standard. The cycle value is however fixed to the value of START IN CYCLE; consists of a network address and a short message vector; no BIW and no message body is generated.</p> <p>ALL   All the information of NID and SSID together.</p> <p>If ROAMING is not set to OFF, the following additional information is included in the telegram:</p> <ul style="list-style-type: none"> <li>– TIME INFO (a BIW010 in phases 0 and 2 of frame 0 and a BIW001 in phases 1 and 3 of frame 0. As the SME is not able to differentiate between cycles, the contents of the phases does not rotate over both BIWs; moreover, <i>no</i> BIW001 is sent for 1600 bps because only one phase is present).</li> <li>– CHANNEL SETUP INSTRUCTION (in one phase in each of the first four frames; for 1600 bps not in the first frame as there is no space; consists of a BIW101; has no address, no vector and no message body).</li> <li>– SYSTEM EVENT NOTIFICATION (starting from frame 0 for a collapse cycle, i.e. <math>2^{sc}</math>, where sc denotes the value set under SYSTEM COLLAPSE VALUE; consists of an operator message address and a short instruction vector, has no message body and no BIW101).</li> <li>– MESSAGE FOR ALL SUBSCRIBERS (is generated depending on the contents of FRAME CONTENTS, also if ROAMING is set to OFF; consists of an operator message address, a vector and a message body, has no BIW101).</li> </ul> <p>IEC-bus command:       : SOUR:FLEX:SINF:ROAM OFF</p>
<b>SSID</b>	The following four commands define the "Simulcast System ID" emitted by the SME.
<b>LOCAL ID</b>	Input value of the local ID. IEC-bus command:       : SOUR:FLEX:SINF:LID 0
<b>COUNTRY CODE</b>	Input value of the country code. IEC-bus command:       : SOUR:FLEX:SINF:COUN 0
<b>COVERAGE ZONE</b>	Input value of the current zone. IEC-bus command:       : SOUR:FLEX:SINF:CZON 0
<b>SSID TMF</b>	Input value of the four traffic management flags for SSID. IEC-bus command:       : SOUR:FLEX:SINF:STMF 15

<b>NID</b>	The following four commands define the "Network Identification" emitted by the SME.
<b>NETWORK ADDRESS</b>	Input value of the network address part of the network ID. IEC-bus command:                   : SOUR:FLEX:SINF:NADD 2058240
<b>MULTIPLIER</b>	Input value of the multiplier part of the network ID. IEC-bus command:                   : SOUR:FLEX:SINF:MULT 1
<b>SERVICE AREA</b>	Input value of the service area part of the network ID. IEC-bus command:                   : SOUR:FLEX:SINF:SAR 0
<b>NID TMF</b>	Input value of the four traffic management fags for NID IEC-bus command:                   : SOUR:FLEX:SINF:NTMF 15
<b>DATE</b>	Input value of the date. IEC-bus command:                   : SOUR:FLEX:SI:DATE 1994,12,01
<b>TIME</b>	Input value of the current time. IEC-bus command:                   : SOUR:FLEX:SI:TIME 12,00
<b>--- MESSAGE ---</b>	The parameters of this section are used for setting the destination address as well as the useful data of the message.
<b>CAPCODE</b>	Input value of the CAPCODE of the pager to be called as printed on the receiver. CAPCODE is defined in FLEX standard. The CAPCODE contains the addresses of the receiver as well as frame and phase information. IEC-bus command:                   : SOUR:FLEX:MESS:CAPC "A0000001"
<b>AUTO ADJUST</b>	Selection of which settings are influenced by a change of CAPCODE: NONE   No influence PHASE   The phase is adjusted to the value contained in CAPCODE. This is performed whenever the setting for CAPCODE is changed. FRAME   FRAME CONTENT is set so that in all the frames evaluated by the receiver (and only in those) FLEX data are also transmitted. However, FRAME CONTENTS is changed only for frames where FRAME CONTENTS contains an 'X', an 'x' or a ' ' (blank). For all other frames, FRAME CONTENTS is left unchanged. BOTH    PHASE as well as FRAME CONTENT are adjusted. IEC-bus command:                   : SOUR:FLEX:PHAS:AUTO ON : SOUR:FLEX:FCON:AUTO ON

<b>PHASE</b>	<p>Selection of which phase (A to D) the message is to be transmitted. Since each frame lasts 1.875 sec independent of the modulation and more data can be transmitted at bit rates higher than 1600 bps, several independent channels ("phases") are bit-multiplexed. With 1600 bps, the message is transmitted for every setting in phase A. With 3200 bps, the message is transmitted in phase A if A and B are set, and transmitted in phase C if C and D are set. With 6400 bps, the message is transmitted in all the four phases depending on the relevant setting. Each pager is set to one phase. The phase can be calculated from the CAPCODE of a pager as shown below:</p> <p>Phase = (Integer(CAPCODE/4)) modulo 4, with 0=A, 1=B, etc.</p> <p>IEC-bus command:                   : SOUR:FLEX:PHAS A</p>
<b>CATEGORY...</b>	<p>Selection of message category for all frames where FRAME CONTENT contains the entry 'X' or 'x'. For all other values of FRAME-CONTENTS, this setting is ignored.</p> <p>TONE            tone-only message  NUMERIC        numeric message,                    with ≤3 figures = short message  SNUMERIC      special numeric message  ALPHANUM      alphanumeric message  SECURE         secure alphanumeric message  BIN             binary message</p> <p>IEC-bus command:                   : SOUR:FLEX:MESS:CAT TONE</p>
<b>REPEATS</b>	<p>Entry of the number of calls following the first call according to FLEX-TD.</p> <p>For the value 0 (no repeat), normal FLEX frames are transmitted, whereas subframes according to FLEX-TD are used with other values. The repeat calls are transmitted at the frame interval defined by the SYSTEM COLLAPSE VALUE. A frame may contain a new message and repetitions of previous messages.</p> <p><b>Notes:</b></p> <ul style="list-style-type: none"> <li>– Since the SME transmits the messages always completely in a (sub-)frame, the maximum length of the SME-generated message decreases with increasing values.</li> <li>– The SME generates a complete cycle which is repeated continuously. Repetitions which are contained in the subsequent cycle are already transmitted in the current cycle, i.e., they might be transmitted prior to transmitting the original.</li> </ul> <p>IEC-bus command:                   : SOUR:FLEX:MESS:REP 0...3</p>
<b>-tone NUMBER</b>	<p>Input value of the tone which is transmitted during category TONE. 8 tones are available.</p> <p>IEC-bus command:                   : SOUR:FLEX:MESS:TONE 0</p>
<b>NUMERIC/SNUMERIC MESSAGE...</b>	<p>Opens a window to enter the character string for a numeric or special numeric message. SME provides a maximum of 41 characters. In addition to the 10 figures "0" to "9" other characters such as square brackets right and left "[", "]", upper case letter "U", hyphen "-" and blank space " " can be used.</p> <p>IEC-bus command:                   : SOUR:FLEX:MESS:NUM "12-17"</p>

<b>ALPHANUM MESSAGE...</b>	<p>Opens a window to select or create an alphanumeric message. The following selection can be made:</p> <p>FOX            "The quick brown fox jumps over the lazy dog"</p> <p>ALPHA        "ABCD..." (complete FLEX character set)</p> <p>USER1...4    Four messages that can be freely edited by command EDIT MESSAGE.</p> <p>IEC-bus command:                    : SOUR : FLEX : MESS : ALPH "FOX"</p>
<b>EDIT MESSAGE...</b>	<p>Opens a window to edit one of the alphanumeric messages USER1 to USER4. The message to be processed has to be selected with ALPHANUM MESSAGE.</p> <p>IEC-bus command:                    : SOUR : FLEX : MESS : ALPH : DATA "Test"</p>
<b>SECURE MESSAGE...</b>	<p>Opens a window to select a secure message. Four messages, USER1 to USER4, are available and can be arbitrarily edited.</p> <p><b>Note:</b>                    <i>The messages can be edited via remote control only.</i></p> <p>IEC-bus command:                    : SOUR : FLEX : MESS : SEC "USER1"</p>
<b>TYPE</b>	<p>Selection of the type of a secure message. The value set here is transmitted via the corresponding bits of the message body and thus determines the character used to fill the remaining space behind the message body. It has no further consequences.</p> <p>IEC-bus command:                    : SOUR FLEX : MESS : SEC : TYPE "ASC"</p>
<b>BINARY MESSAGE...</b>	<p>Opens a window to select a binary message.</p> <p>IEC-bus command:                    : SOUR : FLEX : MESS : BIN : SEL "USER1"</p>
<b>EDIT MESSAGE...</b>	<p>Opens a window to edit one of the binary messages. The message to be processed has to be selected with BINARY MESSAGE. Values 0 and 1 are available. Each value represents 1 bit. The maximum length of the message is 460 bit.</p> <p>IEC-bus command:                    : SOUR : FLEX : MESS : BIN : DATA "1101"</p>
<b>DISPLAY</b>	<p>Selection of direction of binary message.</p> <p>LEFT                    Display from left to right.</p> <p>RIGHT                    Display from right to left.</p> <p>IEC-bus command:                    : SOUR : FLEX : MESS : BIN : DDIR LEFT</p>
<b>BLOCKING LENGTH</b>	<p>Entry of number of bits to be interpreted as a unit (character). Permissible values are 1 to 16.</p> <p>IEC-bus command:                    : SOUR : FLEX : MESS : BIN : BLEN 1</p>
<b>MESSAGE NUMBERING</b>	<p>Selection of whether or not the transmitted message is to be assigned a message number.</p> <p>Every message transmitted can be assigned a message number. This information is evaluated when received by the pager.</p> <p>ON            SME sends the number 0 for every message.</p> <p>OFF        SME sends no number with the message.</p> <p>IEC-bus command:                    : SOUR : FLEX : MESS : MNUM OFF</p>

<b>MAIL DROP FLAG</b>	<p>Switch on/off of MAIL DROP flag</p> <p>ON      The transmitted message is marked as "volatile". Thus, it is not filed in the normal message memory of the pager but in a special memory location and is not subject to normal numbering. The message overwrites the previous "volatile" one.</p> <p>OFF     The message is not marked.</p> <p>IEC-bus command:                    : SOUR : FLEX : MESS : MDR OFF</p>
<b>---BIT ERRORS---</b>	<p>The SME allows for providing a 32-bit-word of the transferred message with bit errors for test purposes. The parameters of this section specify the erroneous bits and their positions.</p>
<b>ERROR BIT MASK</b>	<p>Entry of the erroneous bits in a 32-bit field. The transmitted decimal number (0...4294967295) is converted internally into a 32-bit binary number and thus defines the 32 bits. These bits are XORed with the word of the message which is to be falsified and thus determine which bits of this word are to be transmitted correctly or incorrectly.</p> <p><b>Note:</b>    XORing precedes block interleaving (see FLEX standard)! It is carried out in all phases of all message frames.</p> <p>IEC-bus command:                    : SOUR : FLEX : ERR : MASK 0</p>
<b>POSITION OF ERRONEOUS WORD</b>	<p>Entry value for the position of the word to be falsified. The words are numbered from block 0, word 0 to block 10, word 7 of a frame. The sync part and the frame information word cannot be falsified. The falsification precedes block interleaving in all transmitted phases.</p> <p>IEC-bus command:                    : SOUR : FLEX : ERR : WORD 0</p>
<b>--- MESSAGE GENERATION ---</b>	<p>The parameters of this section determine which types of data (FLEX useful data, FLEX filler data, simulated data of other paging systems or emergency resynchronization) are sent at what time.</p> <p>This can individually be determined for every frame of a cycle with the setting then being valid for <i>all</i> cycles. The cycle and frame numbers are generated and sent in compliance with standard for a period of one hour.</p>
<b>START IN CYCLE</b>	<p>Input value of number of cycle with which the message is started. Valid values are 1 to 14.</p> <p>IEC-bus command:                    : SOUR : FLEX : CYCL 0</p>
<b>START IN FRAME</b>	<p>Input value of the number of the frame in the cycle with which the message is started. Valid values are 1 to 127.</p> <p>IEC-bus command:                    : SOUR : FLEX : FRAM 0</p>

<b>FRAME CONTENTS...</b>	<p>Opens a window to determine the contents of up to 128 frames. Each frame is represented by one character. These characters can be set to the following values:</p> <p>A: alphanumeric message          B: binary message          F: filler frame, contains FLEX structures but no messages identical with &lt;blank&gt;          I: instruction for SSID subscriber units          N: numeric message          O: frame without FLEX structures ("other")          P: special numeric message          R: Emergency Resync Frame, as defined in the FLEX standard          S: Secure Message          T: tone-only message          X: the message type is defined by the value of CATEGORY</p> <p>&lt;blank&gt;:              same as F'          lower case letter:              same as upper case letters but as a "message to all subscribers". Not all message types can be sent as "message to all subscribers" so that not all lower case letters exist.</p> <p>X and blank may be used in order to permit the AUTO ADJUST mechanism (see above) to change this entry.</p> <p><b>Notes:</b> - <i>The SYSTEM COLLAPSE VALUE may cause the pager to respond to much more than only its "own" frame.</i>          - <i>After *RST a character is set in the editor window for each of the 128 frames. It is possible, however, to clear characters by means of the BACKSPACE key. Correspondingly less than 128 frames are then output per cycle. Thus it is possible, for instance, to generate a three-frame test sequence if only the characters for the first three frames are output.</i></p> <p>IEC-bus command:                   : SOUR:FLEX:FCON "O,X,A"</p>
<b>RECALCULATE ►</b>	<p>Triggers a recalculation of the generated FLEX telegram. This action has to be triggered each time a parameter has been changed.</p> <p>Exception: MESSAGE GENERATION MODE.</p> <p>IEC-bus command:                   : SOUR:FLEX:STAT OFF; STAT ON</p>
<b>MODE</b>	<p>Selection of sequence of useful and filler frames.</p> <p><b>ALWAYS</b>   The frames are continuously output according to the setting under FRAME CONTENTS.          IEC-bus command:               : TRIG:DM:SOUR AUTO</p> <p><b>SINGLE</b>    Only FLEX filler data are output. If EXECUTE SINGLE ► is selected, the subsequent frame is output in the way it has been set under FRAME CONTENTS.          IEC-bus command:               : TRIG:DM:SOUR SING                                            : SOUR:FLEX:TACT MESS</p> <p><b>EXT</b>      Only FLEX filler data are output. In the case of an external trigger pulse, the subsequent frame is output in the way it has been set under FRAME CONTENTS.          IEC-bus command:               : TRIG:DM:SOUR EXT                                            : SOUR:FLEX:TACT MESS</p>



**EXTTRIG** The SME only starts with the generation of the FLEX signal after recognition of a trigger pulse at the trigger input connector. After recognition of this signal, the next frame is output in the way it has been specified under FRAME CONTENTS.

IEC-bus command:           :TRIG:DM:SOUR EXT;  
                                  :SOUR:FLEX:TACT ONCE

#### EXTTRIG-ALWAYS

The unit waits for a signal edge at the trigger connector (same as EXTTRIG). After recognition of this edge, the unit behaves as described under setting ALWAYS.

IEC-bus command:           :TRIG:DM:SOUR EXT  
                                  :SOUR:FLEX:TACT STAR

#### EXECUTE SINGLE ►

The next frame is output in the way it has been specified under FRAME CONTENTS. This triggerable action is only displayed and active when MODE SINGLE has been selected.

IEC-bus command:           \*TRG

#### CLOCK SOURCE

Selection of the clock source. This setting is also valid for ERMES, FLEX, REFLEX and POCSAG but not for the other digital modulations.

**INT**       The clock required for signal generation is generated internally and can be tapped at the CLOCK connector.

**EXT**       The signal applied to the CLOCK connector is used as the clock signal.

IEC-bus command:           :SOUR:DM:COMP:CLOC:SOUR INT

**Note:** For all bit rates, i.e. for 1600 bps and 3200 bps, a symbol clock rate of 3200 Hz is always used. This applies to both the output (CLOCK SOURCE INT) and the input (CLOCK SOURCE EXT) of the clock.

### 2.6.3.13 Radiocommunication Service ReFLEX25

When equipped with the SME-B43, SME-B11 and SME-B12 options, the SME generates telegrams complying to the ReFLEX25 standard. The telegram generated by the SME complies with the ReFLEX25 Protocol Specification Document Version 2.4 dated March 15, 1996, issued by the Motorola Advanced Messaging Group.

#### Notes:

- When ReFLEX25 is switched on, all other DM modulations are automatically switched off.
- To permit easier handling, a few settings are automatically updated each time ReFLEX25 is switched on (and RECALCULATE executed) if other settings have been changed. This applies to the RF frequency and the FRAME CONTENTS value. Normally, automatic mode is activated, but it can be deactivated under AUTO ADAPTATION. Parameters that have been set automatically can be varied again at will; these modifications take effect immediately.
- **Fixed values**
  - The following values in the telegram are fixed and cannot be changed:
  - Base frame management (see 3.7.6.10 of the ReFLEX25 documentation): pf = 0, pn = 3, ps = 0, cn = 2, cs = 3, pc = 5
  - ALOHA Time-out and randomization interval (3.7.6.20): ri = 0, t = 0, LT = 0, rt = 0
  - Message sequence number (3.9): msn = 32
  - Vector format (3.10): last word only present if response required = 1. Values: rs = 0, rt = 0, rc = 0, MR = 0; additionally for forward channel scheduling: fc = 0, ff = 0
  - Priority bit in address field is always 0, i.e. only *one* tone-only call.
- **Using the user-definable custom frames CUS1 to CUS9**

The SME permits to output user-definable frames. These frames must be generated on a host processor (e.g. a PC) and transferred to the SME via IEC bus or RS232. The detailed procedure will be described below in the section "Reading out, Modifying, Returning of Telegram Parts", reading out being omitted, of course, if the custom frames are completely generated on the host processor.

The custom frames must have the following data format: Each transmitted symbol of a 4FSK consists of an x and a y bit. X and y bits are filed in two separate byte arrays. The two arrays are transferred to the SME separately. Each byte of the two arrays contains 8 valid x or y bits, which permits to implement a 6400 bps-4FSK. In order to achieve a 2FSK all y bits must be set to 0. In order to obtain lower bit rates, the bits must be doubled accordingly. The SME starts the transmission with the MSB of the byte at the lowest address and stops with the LSB of the byte at the highest address.

### - Bit Error Rate Test

The SME is able to switch a receiver to the test mode for bit error rate tests and then send standard test patterns.

To this end, set a character to "B" (for BER message) in FRAME CONTENTS. Furthermore, set any number of continuous frames to "F" (for filler pattern). In the BER frame, the SME sends the command for switching over to the BER test mode to the receiver. The FPAT frames contain the test pattern.

The command in the BER frame contains start and number of test pattern frames. For calculating the command, the SME searches for the first "F" in FRAME CONTENTS and sets the length to the number of continuous FPAT frames.

The calculation of the BER frame is performed when switching on ReFLEX25 and executing RECALCULATE. This is why FRAME CONTENTS either must be set before switching on ReFLEX2 or RECALCULATE must be executed.

### - Reading Out, Modifying, Returning of Telegram Parts

It is possible to modify parts of the telegram generated by the SME using a host processor and to have the modified telegram sent by the SME. Likewise, telegram parts generated on the host processor can be transferred into the custom frames of the SME.

When ReFLEX25 is switched on, the telegram to be sent is calculated and stored in the extension memory of the SME („XMEM“). The custom frames are *not* changed. For reasons of space, the individual fragments of the telegram are calculated and filed. During the execution, a so-called sequencer makes sure that the individual fragments are read such that a valid and complete telegram is obtained. The sequencer automatically places a sync1 portion, a frame info word and a sync2 portion ahead of all frames except for the types OTH, RSYN and CUS1 to CUS9.

The individual fragments are stored in the XMEM as follows:

Fragment	„start“	„length“
Sync 1 portion	3	224
1920 Frame info words (Ft <sub>1</sub> Ft <sub>0</sub> = 10)	301	1920 * 64
1920 Frame info words (Ft <sub>1</sub> Ft <sub>0</sub> = 11)	125001	1920 * 64
1920 Frame info words (Ft <sub>1</sub> Ft <sub>0</sub> = 00)	250001	1920 * 64
Sync 2 portion	375001	1920 * 80
OTH frame	376001	6000
RSYN frame	383001	5632
IDLE frame	390001	5632
TONE frame	397001	5632
NUM frame	404001	5632
ALPH frame	411001	5632
SCI frame	418001	5632
BER frame	425001	5632
FPAT frame	432001	5632
CUS1 frame	510001	6000
CUS2 frame	520001	6000
CUS3 frame	530001	6000
CUS4 frame	540001	6000
CUS5 frame	550001	6000
CUS6 frame	560001	6000
CUS7 frame	570001	6000
CUS8 frame	580001	6000
CUS9 frame	590001	6000

Separate frame info words are stored for each combination of frame number (0...127) and cycle number (0...14), accounting for the number  $128 * 15 = 1920$  of the frame info words per category.

The following steps are required:

➤ **Generation of a telegram**

Set all ReFLEX25 parameters to the desired values. Make sure that REFLEX25:STATE:AUTO is set to ON. Switch ReFLEX25 on and off again in order to generate a ReFLEX25 telegram in the SME memory. This step is not required for custom frames.

➤ **Reading out of the telegram data**

You can now transfer any parts of the just generated telegram via IEC bus or the serial interface to a host processor. Enter values from the above table for "start" and "length" in order to determine the fragment you wish to read out. Use the following command sequence:

FORMAT PACKED	Data output is performed in binary format
SOUR:DM:DATA:SEL "XMEM"	Determine memory extension as source
SOUR:DM:DATA:XMEM:MODE ALL	Read out x and y bits
SOUR:DM:DATA:XMEM:START start	Specify the start address of the data to be read
SOUR:DM:DATA:XMEM:LENGTH length	Specify the length of the data to be read
SOUR:DM:DATA:DATA?	Read out the x bits
SOUR:DM:DATA:ATT?	Read out the y bits (only required for four-valued modulations)

*The setting commands in this step (except for the two last ones) are also necessary if you wish to transfer custom frames to the SME without reading out data before.*

➤ **Modifying the telegram data**

Each data byte received contains 8 valid x or y bits. The MSB of each byte belongs to the symbol output *first*, the LSB to that output *last* (see also "Using custom frames CUS1...CUS9). These data can now be manipulated using an appropriate PC program.

➤ **Returning the telegram data**

If the settings made during readout have not been changed, the data can simply be returned to the SME using

```
SOUR:DM:DATA:DATA <x bits binary data>
SOUR:DM:DATA:ATT <y bits binary data>
```

When transferring several fragments, "start" and "length" are to be set before.

➤ **Starting ReFLEX25**

Set SOUR:REFL:STAT:AUTO OFF in order to avoid recalculation of the telegram when ReFLEX is started. Then start ReFLEX25.

- **Digital data at output connectors**

In addition to the modulated RF, the digital data and the clock can also be tapped at the output connectors. For the 2-valued modulations (1600bps/2FSK and 3200bps/2FSK), the data appear at the DATA connector. For the four-valued modulations (3200bps/4FSK and 6400bps/4FSK), the x bit of each symbol is output at the DATA connector, the associated y bit at the BURST connector.

When using the internal clock (setting CLOCK SOURCE INT in the menu), the symbol clock is output at the CLOCK connector. **Caution:** Depending on bit rate and type of modulation, a 3200-Hz clock is always output here!

Menu selection: DIGITAL MOD - ReFLEX

FREQ **100.000 000 0** MHz

LEVEL **- 30.0** dBm

FREQUENCY LEVEL MODULATION <b>DIGITAL MOD</b> LF OUTPUT SWEEP LIST MEM SEQ UTILITIES HELP	GMSK GFSK QPSK FSK 4FSK FFSK ERMES FLEX <b>ReFLEX25</b>	<div style="border-bottom: 1px solid black; margin-bottom: 5px;"> <span style="background-color: black; color: white; padding: 2px;">STATE</span> <span style="float: right;">OFF <input type="checkbox"/> ON <input type="checkbox"/></span> </div> MODULATION <span style="border: 1px solid black; padding: 0 5px;">1600-2FSK</span> 3200-2FSK 3200-4FSK 6400-4FSK DEVIATION <span style="float: right;">2.40 kHz</span> -----MESSAGE----- PERSONAL ADDRESS <span style="float: right;">16777216</span> NUMERIC MESSAGE... ALPHANUM MESSAGE... <span style="float: right;">CURRENT:USER4</span> EDIT MESSAGE... RESPONSE REQUIRED <span style="float: right;">ON <input type="checkbox"/> OFF <input type="checkbox"/></span> -----SYSTEM INFORMATION----- ZONE <span style="float: right;">1</span> SUBZONE <span style="float: right;">1</span> SERVICE PROVIDER <span style="float: right;">0</span> FORWARD CHANNEL BASE FREQUENCY <span style="float: right;">929 MHz</span> ASSIGNMENT NUMBER <span style="float: right;">1</span> REVERSE CHANNEL BASE FREQUENCY <span style="float: right;">896 MHz</span> ASSIGNMENT NUMBER <span style="float: right;">2</span> SPEED <span style="border: 1px solid black; padding: 0 5px;">800</span> 1600 6400 9600 FREQUENCY SPACING <span style="float: right;">6250 Hz</span> SCI BASE FRAME <span style="float: right;">0</span> SCI COLLAPSE MASK <span style="float: right;">7</span> -----BIT ERRORS----- ERROR BIT MASK <span style="float: right;">0</span> POSITION OF ERRONEOUS WORD <span style="float: right;">0</span> -----MESSAGE GENERATION----- FRAME CONTENTS... AUTO ADAPTATION <span style="float: right;">OFF <input type="checkbox"/> ON <input type="checkbox"/></span> RECALCULATE ▶ MODE ALWAYS <span style="border: 1px solid black; padding: 0 5px;">SINGLE</span> EXT-SINGLE EXTTRIG EXTTRIG-ALWAYS EXECUTE SINGLE ▶ CLOCK SOURCE <span style="border: 1px solid black; padding: 0 5px;">INT</span> EXT
--	---	---

Fig. 2-50 Menu DIGITAL MOD - ReFLEX, fitted with option SME-B43, ReFlex, option SME-B11, DM coder, and option SM-B12, memory extension

<b>STATE</b>	<p>ON Switches on ReFLEX25. The status line displays the cycle and frame number and the type of output data as well as the word "RFLX" (see table under FRAME CONTENTS).</p> <p>A switchover from STATE OFF to STATE ON results in a recalculation of the telegram and its entry into the list "XMEM". Changing the ReFLEX parameters, except for FRAME CONTENTS, AUTO ADAPTATION, MODE and CLOCK SOURCE, requires a recalculation of data. With radiocommunication service ReFLEX activated (STATE ON), the warning „Signal output / ReFLEX settings mismatch - use RECALCULATE“ is displayed in this case. The recalculation of data can either be effected by switchover to STATE OFF / STATE ON or by triggering RECALCULATE -&gt;</p> <p>OFF Switches off ReFLEX</p> <p>IEC-bus command                    SOUR:REFL25:STAT ON</p>
<b>MODULATION</b>	<p>Selection of used bit rate and modulation. Four modulations are available: 1600bps/2FSK, 3200bps/2FSK, 3200bps/4FSK and 6400bps/4FSK.</p> <p>IEC-bus command:                    SOUR:REFL25:MOD 1600,FSK2</p>
<b>DEVIATION</b>	<p>Input value of frequency deviation of modulation. The deviation specifies the spacing from the carrier to the two further placed symbols in 4FSK. The ReFLEX25 standard specifies 2400Hz for this value which may be varied for testing.</p> <p>IEC-bus command:                    SOUR:REFL25:DEV 2.4kHz</p>
<b>-- MESSAGE --</b>	<p>The parameters of this section permit to set the address of the receiver to be called, define the useful data of the message and determine whether the receiver is to return a confirmation.</p> <p><b>Note:</b> <i>The category of a sent message does not have to be specified in this section. It is rather determined by the selection of appropriate frames under FRAME CONTENTS.</i></p>
<b>PERSONAL ADDRESS</b>	<p>Input value of the address of the receiver to be called. The values range from 16 777 216 to 1 073 741 823.</p> <p>IEC-bus command: SOUR:REFL25:MESS:PADD 16777216</p>
<b>NUMERIC MESSAGE</b>	<p>Opens a window to enter the character string for a numeric message. The SME provides a maximum of 41 characters. In addition to the 10 figures "0" to "9", other characters such as square brackets left and right "[ " and " ]", upper-case letter „U“, hyphen "-" and blank space " " can be used.</p> <p>IEC-bus command:</p> <p style="text-align: center;">SOUR:REFL25:MESS:NUM "[49-89-] 4129-1131"</p>

<b>ALPHANUM MESSAGE</b>	<p>Opens a window to select an alphanumeric message. The following selections can be made:</p> <p>FOX           „The quick brown fox jumps over the lazy dog“</p> <p>ALPHA        „ABCD...“ (complete ReFLEX25 character set)</p> <p>USER1...4   Four messages that can be freely edited by command EDIT MESSAGE. There is one common set of messages for ReFLEX25 and Flex - each modification for ReFLEX25 also changes the message for FLEX.</p> <p>IEC-bus command:           SOUR:REFL25:MESS:ALPH "FOX"</p>
<b>EDIT MESSAGE...</b>	<p>Opens a window to edit the message selected under ALPHANUM MESSAGE. The maximum length of the message is 128 characters.</p> <p>IEC-bus command:                   SOUR:REFL25:MESS:ALPH:DATA "Hello, world!"</p>
<b>RESPONSE REQUIRED:</b>	<p>Determines whether the receiver is to confirm the message or not. The respective bit is set in the message. In the case of OFF the vector field is reduced by one code word if this is permitted by the ReFLEX standard.</p> <p>IEC-bus command:           SOUR:REFL25:MESS:RREQ OFF</p>
<b>-- SYSTEM INFORMATION --</b>	<p>The system information parameters are used for setting the data of the sending system (simulated by the SME). These data are sent to the receiver in the respective block information words.</p>
<b>ZONE</b>	<p>Input value of the geographical transmit zone. The significance is determined by the network operator. The value 0 is referred to as "restricted" in the ReFLEX25 documentation, but can be set for testing. The upper limit is 4091.</p> <p>IEC-bus command:           SOUR:REFL25:SI:ZONE 1</p>
<b>SUBZONE</b>	<p>Input value of the subzone within a transmit zone. The significance is determined by the network operator. The value 0 is referred to as "restricted" in the ReFLEX25 documentation, but can be set for testing. The upper limit is 127.</p> <p>IEC-bus command:           :REFL25:SI:SZONe 1</p>
<b>SERVICE PROVIDER</b>	<p>Input value for the ID of the service provider. Valid values are 0 to 16383.</p> <p>IEC-bus command:           SOUR:REFL25:SI:PROV 0</p>

<b>FORWARD CHANNEL</b>	<p>Together with FREQUENCY SPACING the next two settings determine the frequency of the channel from the transmitter (SME) to the receiver. The following formula is valid in this case:</p> $\text{FREQ} = \text{FORW CHAN BASE FREQUENCY} + \text{FORW CHAN ASSIGNMENT NUMBER} * \text{FREQUENCY SPACING}$ <p>If AUTO ADAPTATION is switched to ON, the frequency calculated when switching on ReFLEX25 and executing RECALCULATE is also transferred to the RF setting of the SME, provided the formula provides a value that lies within the setting range of the SME.</p> <p>The preset values for the following parameters are selected such that the default value of 929.00625 MHz specified in the ReFLEX25 documentation is obtained as frequency.</p>
<b>BASE FREQUENCY</b>	<p>Base frequency of forward channel. Valid values are 0 to 8191 MHz. This exceeds the setting range of the SME. Nevertheless, the set value is transferred to the receiver without being changed.</p> <p>IEC-bus command: <code>SOUR:REFL25:SI:FCH:BASE 929MHz</code></p>
<b>ASSIGNMENT NUMBER</b>	<p>Frequency assignment number. This is <i>not</i> the logic channel number. Valid values are 0 to 2047.</p> <p>IEC-bus command: <code>SOUR:REFL25:SI:FCH:ANUM 1</code></p>
<b>REVERSE CHANNEL</b>	<p>Together with FREQUENCY SPACING, the next two settings determine the frequency of the reverse channel from the receiver to the transmitter (SME). The following formula is valid in this case:</p> $\text{FREQ} = \text{REV CHAN BASE FREQUENCY} + \text{REV CHAN ASSIGNMENT NUMBER} * \text{FREQUENCY SPACING}$ <p>In addition, the bit rate of the reverse channel is specified. The preset values for the following parameters are selected such that the default value of 896.0125 MHz specified in the ReFLEX25 documentation is obtained as frequency.</p>
<b>BASE FREQUENCY</b>	<p>Base frequency of the reverse channel. Valid values are 0 to 8191 MHz.</p> <p>IEC-bus command: <code>SOUR:REFL25:SI:RCH:BASE 896MHz</code></p>
<b>ASSIGNMENT NUMBER</b>	<p>Frequency assignment number. This is <i>not</i> the logic channel number. Valid values are 0 to 2047.</p> <p>IEC-bus command: <code>SOUR:REFL25:SI:RCH:ANUM 2</code></p>
<b>SPEED</b>	<p>Selection of bit rate of reverse channel. Possible selections are 800bps, 1600bps, 6400bps and 9600bps.</p> <p>IEC-bus command: <code>SOUR:REFL25:SI:RCH:SPE 800bps</code></p>
<b>FREQUENCY SPACING</b>	<p>Determines the frequency spacing according to the above formulas for FREQ. This setting applies both to forward and reverse channel. Valid values are 0 to 102350Hz, in steps of 50Hz.</p> <p>IEC-bus command: <code>SOUR:REFL25:SI:FSP 6250Hz</code></p>



**SCI BASE FRAME**

System configuration information (SCI) frames are transmitted within each cycle of 128 frames. Their positions within the cycle is calculated according to

$$\text{INDEX} = \text{SCI BASE FRAME} + 2^{\text{SCI COLLAPSE MASK}} * i \text{ for all } i, \text{ until INDEX exceeds } 127$$

SCI BASE FRAME and SCI COLLAPSE MASK are transmitted to the receiver in the respective block information words.

IEC-bus command:            SOUR:REFL25:SI:SCIBase 0

**SCI COLLAPSE MASK**

See explanation under SCI BASE FRAME.

IEC-bus command:            SOUR:REFL25:SI:SCICollapse 7

**-- BIT ERRORS --**

The SME allows for providing a 32-bit word of the transferred message with bit errors for test purposes. The following parameters specify the bits to be falsified and the position of the erroneous word within a frame. The bit errors are incorporated *before* the individual blocks are subjected to interleaving (see ReFLEX25 documentation).

**ERROR BIT MASK**

Input of the bits to be falsified. The set decimal number is converted internally into a 32-bit binary number. This binary number is XORed with the original message word. Each bit of the ERROR BIT MASK set to 1 causes an inversion of the respective bit in the transmitted word.

IEC-bus command:            SOUR:REFL25:ERR:MASK 0

**POSITION OF ERRONEOUS WORD**

Indicates the position of the erroneous word. The erroneous word appears in each frame. Counting starts with the first word of block 0 of each frame, i.e. immediately *after* the sync partition; the sync partition cannot be falsified. Values from 0 to 351 can be set. Depending on the modulation, a frame (without sync partition) consists of 88, 176 or 352 words. If an excessive value is entered for POSITION OF ERRONEOUS WORD for the set modulation, no bit errors are produced.

IEC-bus command:            SOUR:REFL25:ERR:WORD 0

**-- MESSAGE GENERATION --**

The SME always sends complete cycles consisting of up to 128 frames. The parameters of this section specify the frame contents.

## FRAME CONTENTS

This function specifies the contents of the max. 128 frames sent by the SME during one cycle. A window is opened in which each frame is represented by one character. One of the following frame types can be selected for each of the 128 frames:

Character	Status display	Frame contents
I	IDLE	ReFLEX25 frame without addresses and message contents
A	ALPH	ReFLEX25 frame with alphanumeric message and address
N	NUM	ReFLEX25 frame with numeric message and address
T	TONE	ReFLEX25 frame with tone-only message and address
S	SCI	SCI frame
R	RSYN	Emergency resynchronization frame
B	BER	ReFLEX25 frame with a message that switches the receiver to the bit-error-test mode
F	FPAT	ReFLEX25 test filler pattern according to section 10.1 of the ReFLEX25 standard
O	OTH	Simulated data of another radiocommunication service; contains no ReFLEX structures at all
1...9	CUS1 to 9	Custom frames, freely definable by the user (see operating instructions at the end of this section)

**Notes:**

- A cycle can also be reduced to less than 128 frames. Each time the -/←- key is pressed, a frame character is deleted and the cycle thus reduced by one frame. Hatched areas are displayed. In this case, the SME starts the next cycle earlier.
- FRAME CONTENTS can also be varied while ReFLEX25 is active.
- For using the frame types BER and FPAT see also section „Bit Error Rate Test“
- In the modes MODE SINGLE and MODE EXT-SINGLE all ALPH, NUM und TONE frames are replaced by IDLE frames as long as no trigger event has arrived or EXECUTE SINGLE has not been triggered.

IEC-bus command: IEC-bus command:  
 SOUR:REFL25:FCON "SAAAAAAAAAAAAAAAA... " (abbreviated)

## AUTO ADAPTATION

If AUTO ADAPTATION is set to ON, the following settings are performed automatically as soon as ReFLEX25 is switched on or RECALCULATE is triggered. In detail, the following settings are performed:

FORWARD CHANNEL BASE FREQUENCY, ASSIGNMENT NUMBER and FREQUENCY SPACING are used to calculate and set the RF.

The automatically set values can be varied subsequently without recalculation of the telegram. These modifications take effect immediately. However, they do *not* react on the output parameters.

IEC-bus command: SOUR:REFL25:AAD ON

**RECALCULATE →**

Triggers recalculation of the generated ReFLEX25 telegram and - with AUTO ADAPTATION set to ON - an update of the RF frequency. The execution of RECALCULATE is required when a setting is changed that influences the telegram. This includes all parameters except for FRAME CONTENTS, AUTO ADAPTATION, MODE and CLOCK SOURCE. The same result can be obtained by briefly switching ReFLEX25 off and on again.

IEC-bus command: SOUR:REFL25:STAT OFF; STAT ON

**MODE**

Selection of the output mode. The contents of the individual frames is mainly determined by FRAME CONTENTS. However, MODE also performs an interpretation in this case.

**ALWAYS** The SME starts with the generation of the ReFLEX25 signal immediately after switching on of ReFLEX25. The frames are sent in the way they have been specified under FRAME CONTENTS.

IEC-bus command: :TRIG:DM:SOUR AUTO

**SINGLE** The SME starts with the generation of the ReFLEX25 signal immediately after switching on of ReFLEX25. All ALPH, NUM and TONE frames are replaced by IDLE frames. By selecting EXECUTE SINGLE, *one* ALPH, NUM or TONE frame (as specified in FRAME CONTENTS) is transmitted; all further ALPH, NUM and TONE frames are again replaced by IDLE frames until EXECUTE SINGLE is triggered again.

IEC-bus command:

:TRIG:DM:SOUR SING;  
:SOUR:REFL25:TACT MESS

**EXT-SINGLE** The SME starts with the generation of the ReFLEX25 signal immediately after switching on of ReFLEX25. EXT-SINGLE behaves like SINGLE, however, instead of EXECUTE SINGLE, a trigger signal is required at the trigger input connector.

IEC-bus command:

:TRIG:DM:SOUR EXT;  
:SOUR:REFL25:TACT MESS

**EXTTRIG** The SME only starts with the generation of the ReFLEX25 signal after recognition of a trigger pulse at the trigger input connector. After recognition of this signal, exactly one cycle (up to 128 frames) is output. The frames are output in the way they have been specified in FRAME CONTENTS. After execution of the cycle, the SME waits for a new trigger pulse.

IEC-bus command:

:TRIG:DM:SOUR EXT;  
:SOUR:REFL25:TACT ONCE

EXTTRIG-ALWAYS The SME only starts with the generation of the ReFLEX25 signal after recognition of a trigger pulse at the trigger input connector. Then, this mode behaves as described under the setting ALWAYS. This setting can be used to synchronize two SMEs.

IEC-bus command

```
:TRIG:DM:SOUR EXT;
:SOUR:REFL25:TACT STAR
```

#### EXECUTE SINGLE →

See description of MODE SINGLE

IEC-bus command: \*TRG

#### CLOCK SOURCE

Selection of the clock source. This setting applies to ERMES, POCSAG, FLEX and REFLEX at the same time, however not to the other digital modulations. The EXT setting can be used to synchronize two or more SMEs.

INT The clock required for signal generation is generated internally and can be tapped at the CLOCK connector.

EXT The signal applied to the CLOCK connector is used as the clock signal.

IEC-bus command: :SOUR:DM:COMP:CLOC INT

**Note:** For all bit rates, i.e. for 1600bps and 3200bps also, a symbol clock rate of 3200Hz is always used. This applies both to the output (CLOCK SOURCE INT) and to the input (CLOCK SOURCE EXT) of the clock

### 2.6.3.14 Radiocommunication Service POCSAG

POCSAG is a standard which in its various implementations (e.g. CITYRUF, SCALL) allows convenient paging. When equipped with the SME-B42 (POCSAG), SME-B11 (DM coder) and SME B12 (DM memory extension) options, the SME generates call signals complying to the POCSAG standard. All essential parameters and the message to be transmitted are freely selectable.

- Notes:** – When POCSAG is switched on, all other DM modulations are automatically switched off.  
 – The RF frequency is not determined by the POCSAG standard, it has to be set to the desired value by means of key [FREQ].

POCSAG settings can be accessed via DIGITAL-MOD-POCSAG menu:

The screenshot shows the DIGITAL-MOD-POCSAG menu with the following settings:

- FREQ: 100.000 000 0 MHz
- LEVEL: -30.0 dBm
- STATE: ON
- MODULATION: FSK
- DEVIATION: 4.5 kHz
- MOD POLARITY: NORM
- LEVEL ATTENUATION: 0.0 dB
- BITRATE: 512 bps
- MESSAGE: ADDRESS 1, CATEGORY TONE, SYNC WORD POCSAG, TONE NUMBER A, NUMERIC MESSAGE... A, ALPHANUM MESSAGE... B, EDIT MESSAGE... C, CURRENT: USER3
- BIT ERRORS: ERROR BIT MASK 0, POSITION OF ERRONEOUS WORD 0
- MESSAGE GENERATION: FILL-BATCHES BEFORE MESSAGE 0, TIME SLICE 10 sec
- RECALCULATE: ALWAYS
- EXECUTE SINGLE: SINGLE
- CLOCK SOURCE: INT

Fig. 2-51 Menu DIGITAL MOD-POCSAG

<b>STATE</b>	ON	Switch on of POCSAG. The RF frequency has to be set to the desired value by means of key [FREQ]. An indication appears in the status line: "PRE" stands for preamble. "MSGx" stands for message, the number "x" denotes the current batch, "- - -" stands for filler data (see POCSAG standard). IEC-bus command SOUR:POCS:STAT ON
	OFF	Switch off of POCSAG. IEC-bus command SOUR:POCS:STAT OFF

<b>MODULATION</b>	<p>Selection of used modulation. Two types are available:</p> <p>FSK     The RF is directly modulated with the data signal.</p> <p>FFSK    An LF is first modulated, which is then used as the modulation signal for the RF.</p> <p>IEC-bus command                    SOUR:POCS:MOD FSK</p>
<b>DEVIATION</b>	<p>Input value of frequency deviation of modulation.</p> <p>For FSK 4.0 kHz and 4.5 kHz are possible, for FFSK 1.5 kHz, 2.0 kHz, 3.0 kHz, 3.5 kHz, 4.0 kHz and 4.5 kHz. The instrument stores two independent deviation values (one for each type of modulation). The value which is displayed and used depends on the modulation setting.</p> <p>IEC-bus command                    SOUR:POCS:DEV 4.5kHz</p>
<b>MOD POLARITY</b>	<p>Selection of the polarity of the modulation.</p> <p>NORM    Polarity of modulation according to standard POCSAG.</p> <p>INV     Polarity of modulation inverted.</p> <p>IEC-bus command                    SOUR:POCS:POL NORM</p>
<b>LEVEL ATTENUATION</b>	<p>Input value for the level attenuation. According to FTZ 171TR1 section 4.5.4.2, the levels of the batches no. 2 up to no. 5 are reduced by the value set here.</p> <p><b>Notes:</b> – <i>This setting has an impact only, when a message or filler batches are transmitted in any of the batches 2 to 5. The unmodulated carrier emitted between the end of the message and the beginning of the next call is not attenuated. Usually, the message is transmitted in the first batch. By setting FILL-BATCHES BEFORE MESSAGE, however, the filler batches can be inserted prior to the actual message.</i></p> <p>– <i>Entry of a value in this menu changes the LEVEL ATTENUATION-value of the other DM-modulations, too.</i></p> <p>IEC-bus command                    SOUR:DM:DATA:ALEV 0dB</p>
<b>BITRATE</b>	<p>Selection of bitrate, at which the data should be outputted. Possible values are:</p> <p>512, 1200 and 2400 baud.</p> <p>IEC-bus command                    SOUR:POCS:BRAT 512bps</p>
<b>--- MESSAGE ---</b>	<p>The parameters of this section are used for setting the destination address as well as the useful data of the message.</p>
<b>ADDRESS</b>	<p>Input value of the address of the pager to be called. The specified range is 0 to 2097151.</p> <p>IEC-bus command                    SOUR:POCS:MESS:ADDR 1</p>
<b>CATEGORY</b>	<p>Selection of the category of the transmitted message.</p> <p>NUMERIC            numeric message,</p> <p>TONE                tone-only message</p> <p>ALPHANUMERIC    alphanumeric message</p> <p>IEC-bus command                    SOUR:POCS:MESS:CAT TONE</p>

**SYNC WORD** Selection of the contents of the sync word.  
This word distinguishes between the various types of paging services.  
POCSAG 0x7CD215D8; also used for CITYRUF  
INFORUF 0x7CD21436.  
IEC-bus command :SOUR:POCS:MESS:SWOR POCS

**TONE NUMBER** Input value of the tone which is transmitted during category TONE.  
Four tones are available (A, B, C, D).  
**Notes:** – Only true tone-only receivers can process all four possible values.  
– Numerical and alphanumeric receivers react to tone-only pages only when tone number is B or C.  
IEC-bus command :SOUR:POCS:MESS:TONE B

**NUMERIC MESSAGE...** Opens a window to enter the character string for a numeric or special numeric message. SME provides a maximum of 41 characters. Characters 0 to 9, U, -, [, ] and blank space may be used.  
IEC-bus command :SOUR:POCS:MESS:NUM "12-17"

**ALPHANUM MESSAGE...** Opens a window to select or create an alphanumeric message. There is one common character set for FLEX (option SME-B41) and POCSAG.  
FOX "The quick brown fox jumps over the lazy dog"  
ALPHA "ABCD..." (complete POCSAG character set)  
USER1...4 Four messages that can be freely edited by command EDIT MESSAGE.  
IEC-bus command :SOUR:POCS:MESS:ALPH:SEL "USER3"

**EDIT MESSAGE...** Opens a window to edit one of the alphanumeric messages USER1 to USER4.  
The following conversions are used for the German CITYRUF network:

Hex-value	USA	Germany
0x5B	[	Ä
0x5C	\	Ö
0x5D	]	Ü
0x7B	{	ä
0x7C		ö
0x7D	}	ü
0x7E	~	ß

IEC-bus command :SOUR:POCS:MESS:ALPH:DATA "Hello"

<b>---BIT ERRORS---</b>	The SME allows for providing a 32-bit-word of the transferred message with bit errors for test purposes. The parameters of this section specify the erroneous bits and their positions.
<b>ERROR BIT MASK</b>	Entry of the erroneous bits in a 32-bit field. The transmitted decimal number (0...4294967295) is converted internally into a 32-bit binary number and thus defines the 32 bits. These bits are XORed with the word of the message which is to be falsified and thus determine which bits of this word are to be transmitted correctly or incorrectly. IEC-bus command : SOUR:POCS:ERR:MASK 0
<b>POSITION OF ERRONEOUS WORD</b>	Entry value of the position of the word to be falsified in the batch. Values from 0 to 16 are valid. The value 0 denotes the synchronization word. IEC-bus command : SOUR:POCS:ERR:WORD 0
<b>--- MESSAGE GENERATION ---</b>	The parameters of this section determine which types of data (POCSAG message, POCSAG filler data) are sent at what time.
<b>FILL-BATCHES BEFORE MESSAGE</b>	Input value for the number of filler batches emitted prior to the actual message. This allows, e. g., to create a test message according to FTZ 171TR1, appendix 1, section 3.2.2, where the message must appear in the 7 <sup>th</sup> batch IEC-bus command : SOUR:POCS:LBAT 0
<b>TIME SLICE</b>	Input value of the length of the time slice. Possible values are: 2 to 120 sec. A preamble of 576 bits is sent at the beginning of every time slice, followed by the number of filler batches set under FILL-BATCHES BEFORE MESSAGE. Each batch has the length of 544 bits. Depending on the settings under MODE, zero, one or two message batches follow. Then an unmodulated signal is sent up to the end of the time slice. Due to the fact that only complete code word groups are sent, it is possible that, depending on the set bit rate, the actual length of the time slice slightly differs from the set length of the time slice. IEC-bus command : SOUR:POCS:TSL 10
<b>RECALCULATE →</b>	Triggers a recalculation of the generated POCSAG telegram. The telegram which is to be sent is recalculated using the set values. As a result of this function, a change in the settings also becomes effective in the generated signal. IEC-bus command : SOUR:POCS:STAT OFF;STAT ON



**MODE**

Selection of sequence of messages and filler data.

**ALWAYS** The message is continuously output according to the time interval which is set under TIME SLICE.

IEC-bus command :TRIG:DM:SOUR AUTO

**SINGLE** The time slices without message are continuously output. If EXECUTE SINGLE is selected, a time slice with the message is output once.

IEC-bus command :TRIG:DM:SOUR SING  
:SOUR:POCS:TACT MESS

**EXT** The time slices without message are continuously output. If EXECUTE SINGLE is selected, a time slice with the message is output once.

IEC-bus command:TRIG:DM:SOUR EXT  
:SOUR:POCS:TACT MESS

**EXTTRIG** The SME only starts with the generation of the POCSAG signal after recognition of a trigger pulse at the trigger input connector. After recognition of this signal, exactly one message is output.

IEC-bus command:TRIG:DM:SOUR EXT;  
:SOUR:POCS:TACT ONCE

**EXTTRIG-ALWAYS**

The unit waits for a signal edge at the trigger connector. After recognition of this edge, the unit behaves as described under setting ALWAYS.

IEC-bus command: :TRIG:DM:SOUR EXT;  
:SOUR:POCS:TACT STAR

**EXECUTE SINGLE →**

The set message is output exactly once at the next possible point of time. This triggerable action is only displayed and active when MODE SINGLE has been selected.

IEC-bus command \*TRG

**CLOCK SOURCE**

Selection of the clock source. This setting is also valid for ERMES, FLEX and REFLEX but not for the other digital modulations.

**INT** The clock required for signal generation is generated internally and can be tapped at the CLOCK connector.

**EXT** The signal applied to the CLOCK connector is used as the clock signal.

**Note:** For all bit rates, i.e. for 1600 bps and 3200 bps, a symbol clock rate of 3200 Hz is always used. This applies to both the output (CLOCK SOURCE INT) and the input (CLOCK SOURCE EXT) of the clock.

IEC-bus command :SOUR:DM:COMP:CLOC:SOUR INT

## 2.7 LF-Output

Depending on which options are fitted (cf. table 2-4), internal LF generator 1 and/or 2 are available as a signal source for the LF output.

Menu LF OUTPUT offers access to the settings of the LF output.

- Notes:**
- An alteration of the waveform or frequency of the internal modulation generators in the LF-output menu has a parallel effect on the modulation for which the respective generator is selected as modulation source.
  - The SWEEP function of LF generator 2 can be activated in menu SWEEP-LF-GEN2.
  - Key [G/n] dBμ switches the unit of the display / LF level output voltage setting to dBu.

Menu selection: LF OUTPUT

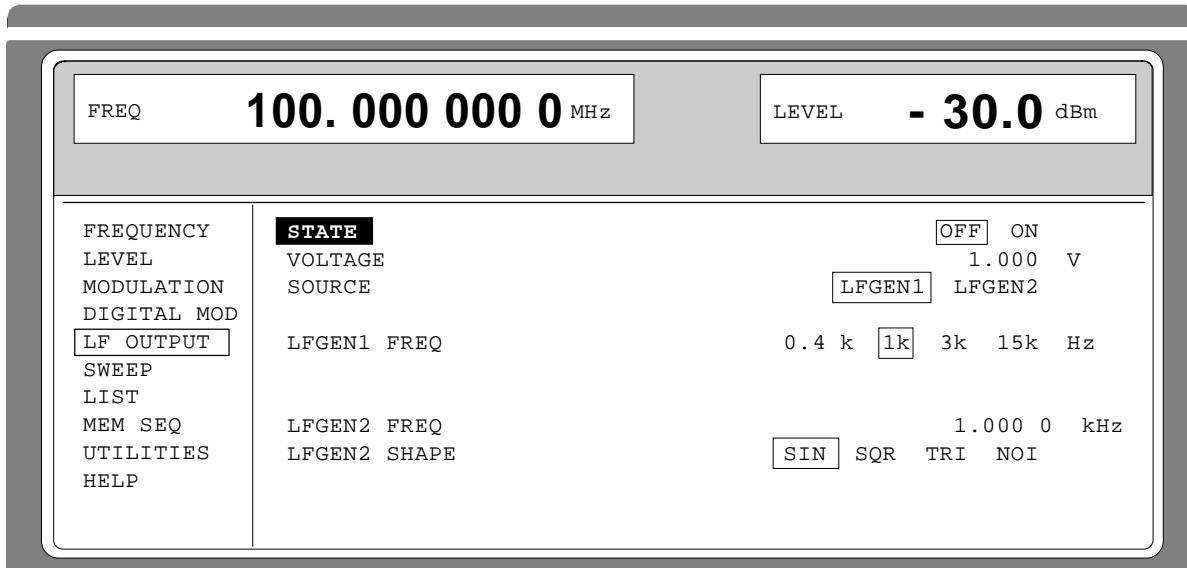

Fig. 2-52 Menu LF OUTPUT (preset setting), fitted with option SM-B6, multifunction generator

**STATE** Switching on/off the LF output. Parameter LF STATE has no influence on the modulation settings.

IEC bus short command :OUTP2 ON

**VOLTAGE** Input value of the output voltage of the LF output. The input is effected in the form of a peak voltage. If no LF generator option is fitted, the constant output voltage of the standard generator ( $V_S = 1\text{ V}$ ) is indicated.

IEC Bus short command :OUTP2:VOLT 1V

- Notes:** If LF generator 2 (LFGEN2) is selected as source and
- STEREO operating mode is activated, the voltage of the LF output depends on the setting of the wanted and the pilot deviation and cannot be changed in this menu. The output voltage is 6 dBu (1.55 VRMS at 600 ?) per 40 kHz of set sum deviation. The following is displayed:  
VOLTAGE (STEREO) 6dBu / 40 kHz
  - one of operating modes VOR, ILS-GS or ILS-LOC is activated, the input of the output voltage of the LF output is effected relative to the set sum modulation depth. The following is displayed, e.g. in the case of VOR modulation:  
VOLTAGE (VOR/ILS) per 100% DEPTH 1.000 V

<b>LF SOURCE</b>	Selection of the signal source for the LF output. IEC bus short command :OUTP2:SOUR 0 (Selection of LF generator 1) :OUTP2:SOUR 2 (Selection of LF generator 2)
<b>LFGEN1 FREQ</b>	Input value of the frequency of internal modulation generator 1. IEC bus short command :SOUR0:FREQ 1kHz
<b>LFGEN1 SHAPE</b>	Input value of the signal shape for modulation generator 1. The signal shape of modulation generator 1 can only be set if two modulation generator options are fitted. IEC bus short command :SOUR0:FUNC SIN
<b>LFGEN2 FREQ</b>	Input value of the frequency of internal modulation generator 2. This parameter is only displayed if a modulation generator option is fitted. IEC bus short command :SOUR2:FREQ 1kHz  <b>Note:</b> In operating modes Stereo, VOR, ILS... or LF-Sweep the value indication is replaced by "STEREO", "VOR", "ILS.." or "SWEEP".
<b>LFGEN2 SHAPE</b>	Input value of the signal shape of modulation generator 2. This parameter is only displayed if a modulation generator option is fitted. IEC bus short command :SOUR2:FUNC SIN  <b>Notes:</b> <ul style="list-style-type: none"> <li>- A selection of signal shape NOI in the LF-SWEEP operating mode automatically leads to this operating mode being aborted.</li> <li>- In operating modes STEREO, VOR, ILS.. an indication of this parameter is eliminated. Instead, a selection between STEREO OUTPUT MPX and PILOT is possible (see below).</li> </ul>
<b>STEREO OUTPUT</b>	Selection of the stereo signal at the LF output. This parameter is only displayed if STEREO modulation is activated. MPX Output of the complete Stereo multiplex signal. PILOT Output of the pilot tone. IEC bus short commands :SOUR:STER:STAT ON; :OUTP2:SOUR 2; :OUTP2:SOUR:STER MPX

## 2.8 Sweep

The SME offers a digital step-by-step sweep for parameters:

- RF frequency
- LF frequency
- RF level

In addition to the digital step-by-step sweep, an analog sweep for RF frequency and RF level is possible by switching on frequency or amplitude modulation with an internal saw tooth.

Setting a sweep is effected in five basic steps which are shown in the following example, the setting of a frequency sweep:

1. Set sweep range (START and STOP or CENTER and SPAN).
2. Select linear or logarithmic sequence (SPACING).
3. Set step width (STEP) and dwell time (DWELL).
4. Activate marker if desired (MARKER).
5. Switch on sweep (MODE set to AUTO, SINGLE or STEP).

### 2.8.1 Setting the Sweep Range (START, STOP, CENTER and SPAN)

The sweep range of the RF sweep can be entered in two different ways. Either by entering the START and STOP value or by entering CENTER and SPAN. Please observe that the two parameter sets influence one another. The influence is exerted in the following way:

- START frequency altered:
 

STOP	=	unaltered
CENTER	=	$(START + STOP)/2$
SPAN	=	$(STOP - START)$
- STOP frequency altered:
 

START	=	unaltered
CENTER	=	$(START + STOP)/2$
SPAN	=	$(STOP - START)$
- CENTER frequency altered
 

SPAN	=	unaltered
START	=	$(CENTER - SPAN/2)$
STOP	=	$(CENTER + SPAN/2)$
- SPAN frequency altered:
 

CENTER	=	unaltered
START	=	$(CENTER - SPAN/2)$
STOP	=	$(CENTER + SPAN/2)$

## 2.8.2 Selecting the Sweep Run (SPACING LIN, LOG)

The sweep run, linear or logarithmic, can be selected using SPACING. For the RF and LF sweep, a linear or logarithmic run is possible. For level sweep, only the logarithmic run is possible.

With the logarithmic sweep, step width STEP is equal to a constant fraction of the present setting. The logarithmic step width is entered in unit % with RF or LF sweep, in unit dB with level sweep.

## 2.8.3 Operating Modes (MODE)

The following sweep operating modes are available:

**AUTO** Sweep from the starting point to the stop point, with automatic restart at the starting point. If another sweep operating mode was activated prior to the AUTO operating mode, continuation is made from the current sweep setting (cf. Fig. 2-52).

IEC bus short commands:

RF sweep:	LF sweep:	Level sweep:
SOUR:FREQ:MODE SWE	SOUR2:FREQ:MODE SWE	SOUR:POW:MODE SWE
SOUR:SWE:MODE AUTO	SOUR2:SWE:MODE AUTO	SOUR:SWE:POW:MODE AUTO
TRIG:SOUR AUTO	TRIG2:SOUR AUTO	TRIG:SOUR AUTO

**SINGLE** Single run from the starting point to the stop point. If SINGLE is selected, the run is not started yet. Function EXECUTE SINGLE SWEEP → to be executed, which can be used to start the run, is displayed below the MODE line (cf. Fig. 2-53).

IEC bus short commands:

RF sweep:	LF sweep:	Level sweep:
SOUR:FREQ:MODE SWE	SOUR2:FREQ:MODE SWE	SOUR:POW:MODE SWE
SOUR:SWE:MODE AUTO	SOUR2:SWE:MODE AUTO	SOUR:SWE:POW:MODE AUTO
TRIG:SOUR SING	TRIG2:SOUR SING	TRIG:SOUR SING

**STEP** Step-by-step, manual run within the sweep limits. Activating STEP stops a running sweep and the cursor wraps to the indication value of CURRENT. The sweep run can now be controlled upwards or downwards in discrete steps using the rotary knob or the numeric keys.

IEC bus short commands:

RF sweep:	LF sweep:	Level sweep:
SOUR:FREQ:MODE SWE	SOUR2:FREQ:MODE SWE	SOUR:POW:MODE SWE
SOUR:SWE:MODE STEP	SOUR2:SWE:MODE STEP	SOUR:SWE:POW:MODE STEP
TRIG:SOUR SING	TRIG2:SOUR SING	TRIG:SOUR SING

**EXT-SINGLE** Single run from the starting point to the stop point as in the case of SINGLE, but triggered by an external trigger signal.

IEC-bus commands:

RF sweep:	LF sweep:	Level sweep:
SOUR:FREQ:MODE SWE	SOUR2:FREQ:MODE SWE	SOUR:POW:MODE SWE
SOUR:SWE:MODE AUTO	SOUR2:SWE:MODE AUTO	SOUR:SWE:POW:MODE AUTO
TRIG:SOUR EXT	TRIG2:SOUR EXT	TRIG:SOUR EXT

**EXT-STEP** Step-by-step run by means of the external trigger signal. Each trigger event triggers a single step.

IEC-bus commands:

RF sweep:

SOUR:FREQ:MODE SWE  
SOUR:SWE:MODE STEP  
TRIG:SOUR EXT

LF sweep:

SOUR2:FREQ:MODE SWE  
SOUR2:SWE:MODE STEP  
TRIG2:SOUR EXT

Level sweep:

SOUR:POW:MODE SWE  
SOUR:SWE:POW:MODE STEP  
TRIG:SOUR EXT

**OFF** The sweep operating mode is switched off.

IEC-bus commands:

RF sweep:

SOUR:FREQ:MODE CW

LF sweep:

SOUR2:FREQ:MODE CW

Level sweep:

SOUR:POW:MODE CW

## 2.8.4 Trigger Input

An external signal at the rear input triggers the sweep in the EXT-SINGLE and EXT-STEP operating modes. The polarity of the active trigger edge can be set in menu UTILITIES - AUX I/O EXT TRIG SLOPE .

## 2.8.5 Sweep Outputs

Outputs X-AXIS, BLANK and MARKER are available at the rear of the instrument to control and trigger oscilloscopes or XY recorders.

**X-AXIS** With sweep switched on, this output supplies a voltage ramp of 0 to 10 V for the X-deflection of an oscilloscope or an XY recorder.

**BLANK** This output supplies a signal (0V/5V) to trigger and blank an oscilloscope or for the PEN LIFT control of an XY recorder. The polarity and the period of the signal can be set under UTILITIES - AUX I/O - BLANK POLARITY and - BLANK TIME.

**MARKER**

This output becomes active when the sweep run has reached the mark. The MARKER signal can be used for the brightness control of an oscilloscope. Up to three marks can be set in order to mark certain positions in the sweep run. The polarity of the signal can be set in menu UTILITIES - AUX I/O - MARKER POLARITY. The period of the active signal is equal to the dwell time (DWELL) of a step.

**Signal examples:**

Fig.

Fig. 2-53 Signal example sweep: MODE = AUTO, BLANK TIME = NORMAL

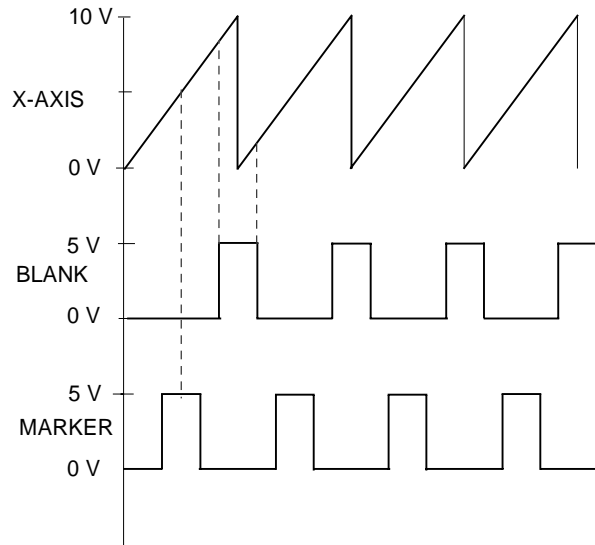
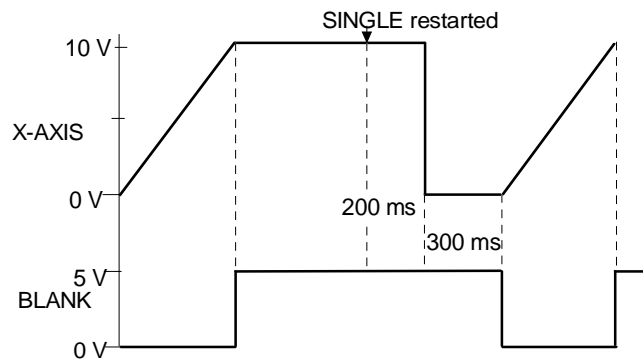

Fig. 2-54 Signal example sweep: MODE = SINGLE, BLANK TIME = LONG

## 2.8.6 RF-Sweep

Menu SWEEP - FREQ offers access to settings for RF sweep.

Menu selection: SWEEP - FREQ

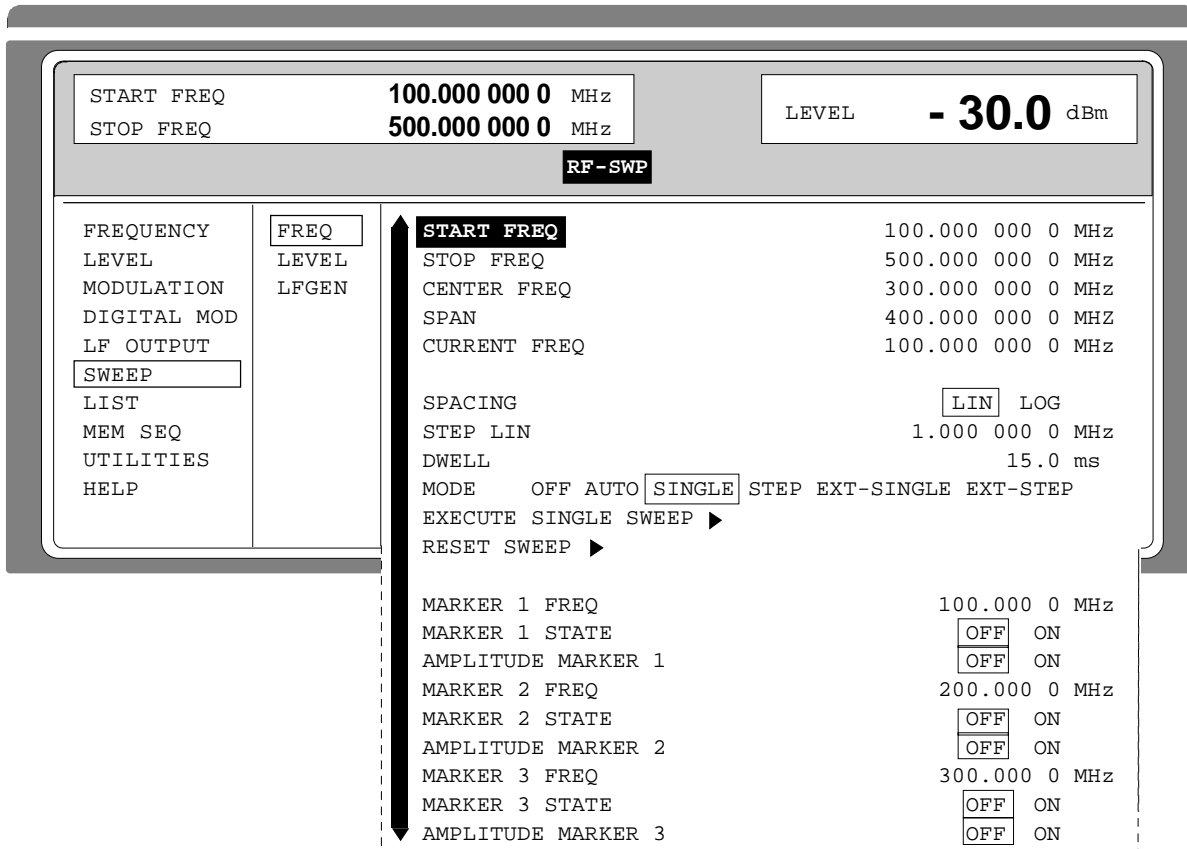

Fig. 2-55 Menu SWEEP - FREQ

### 2.8.6.1.1.1.1.1.1

- START FREQ** Input value of the starting frequency.  
IEC bus short command : SOUR:FREQ:STAR 100MHZ
- STOP FREQ** Input value of the stop frequency.  
IEC bus short command : SOUR:FREQ:STOP 500MHZ
- CENTER FREQ** Input value of the center frequency.  
IEC bus short command : SOUR:FREQ:CENT 300MHZ
- SPAN** Input value of the span.  
IEC bus short command : SOUR:FREQ:SPAN 100MHZ
- CURRENT FREQ** Indication of the current frequency value.  
Operating mode STEP: Input value of the frequency.
- STEP LIN (LOG)** Input value of the step width. Depending on whether SPACING LIN or LOG is selected, STEP LIN or STEP LOG is displayed.  
IEC bus short command : SOUR:SWE:STEP:LIN 1MHZ



<b>DWELL</b>	Input value of the dwell time per step. IEC bus short command : SOUR:SWE:DWEL 10ms
<b>SPACING</b>	Input value of the dwell time per step. IEC bus short command : SOUR:SWE:SPAC LIN
<b>MODE</b>	Selection of the sweep operating mode (cf. Section 2.8.3).. IEC bus short commands : SOUR:FREQ:MODE SWE; :SWE:MODE AUTO; :TRIG:SOUR SING
<b>EXECUTE SINGLE SWEEP ►</b>	Starts a single sweep run. This action to be executed is only indicated and is only effective if MODE SINGLE has been selected. IEC bus short command : TRIG
<b>RESET SWEEP ►</b>	Sets the starting frequency. IEC bus short command : ABOR
<b>MARKER 1 FREQ MARKER 2 FREQ MARKER 3 FREQ</b>	Input value of the frequency for the marker selected IEC bus short command : MARK1:FREQ 100MHz
<b>MARKER 1 STATE MARKER 2 STATE MARKER 3 STATE</b>	Switching on/off the marker selected IEC bus short command : SOUR:MARK1 OFF
<b>AMPLITUDE MARKER1 AMPLITUDE MARKER 2 AMPLITUDE MARKER 3</b>	Switching on/off the amplitude marker selected OFF Input value of the frequency for the marker selected ON Amplitude marker is switched on. On reaching the mark the output level is reduced by 1 dB. IEC bus short command : SOUR:MARK1:AMPL OFF

## 2.8.7 LEVEL Sweep

Menu SWEEP - LEVEL offers access to settings for LEVEL sweep.

Menu selection: SWEEP - LEVEL

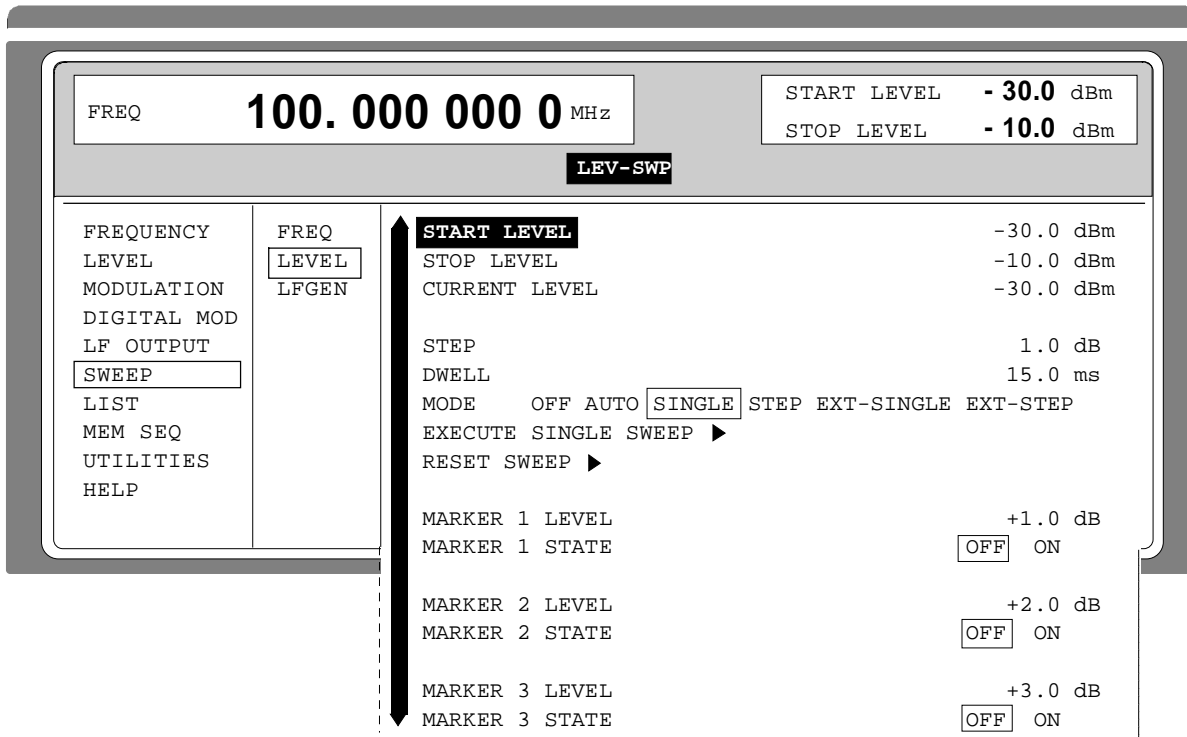

Fig. 2-56 Menu SWEEP - LEVEL

<b>START LEVEL</b>	Input value of the starting level. IEC bus short command : SOUR:POW:STAR -30dBm
<b>STOP LEVEL</b>	Input value of the stop level. IEC bus short command : SOUR:POW:STOP -10dBm
<b>CURRENT LEVEL</b>	Indication of the current level. Operating mode STEP: Input value of the level.
<b>STEP</b>	Input value of the step width. IEC bus short command : SOUR:SWE:POW:STEP 1dB
<b>DWELL</b>	Input value of the dwell time per step IEC bus short command : SOUR:SWE:POW:DWEL 15ms
<b>MODE</b>	Selection of the sweep operating mode (cf. Section 2.8.3). IEC bus short command : SOUR:POW:MODE SWE; : SOUR:SWE:POW:MODE AUTO; :TRIG:SOUR SING

- EXECUTE SINGLE SWEEP →** Starts a single sweep run. This action to be executed is only indicated and is only effective if MODE SINGLE is selected.  
IEC bus short command :TRIG
  
- RESET SWEEP →** Sets the starting level.  
IEC bus short command :ABOR
  
- MARKER 1 LEVEL**  
**MARKER 2 LEVEL**  
**MARKER 3 LEVEL** Input value of the level for the marker selected.  
IEC bus short command : SOUR:MARK1:PSW:POW 0dBm
  
- MARKER 1 STATE**  
**MARKER 2 STATE**  
**MARKER 3 STATE** Switching on/off the marker selected.  
IEC bus short command : SOUR:MARK1:PSW OFF

### 2.8.8 LF-Sweep

Menu SWEEP - LF GEN offers access to settings for LF sweep.

**Note:** Settings LF SWEEP and SOURCE LFGEN2 SHAPE NOI deactivate one another.

Menu selection: SWEEP - LF GEN2

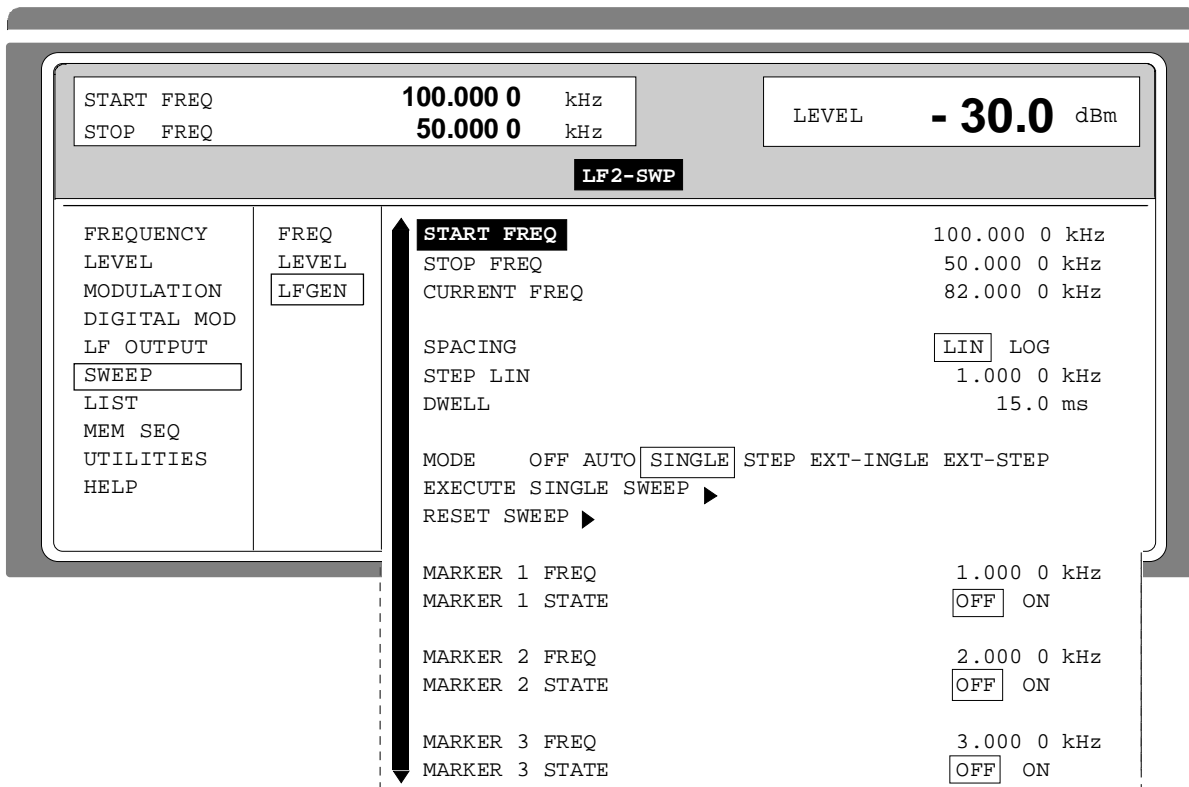

Fig. 2-57 Menu SWEEP - LF GEN

<b>START FREQ</b>	Input value of the starting frequency. IEC bus short command : SOUR:SOUR2:FREQ:STAR 100kHz
<b>STOP FREQ</b>	Input value of the stop frequency. IEC bus short command : SOUR2:FREQ:STOP 50kHz
<b>CURRENT FREQ</b>	Indication of the current frequency value. Operating mode STEP: Input value of the frequency.
<b>STEP</b>	Input value of the step width. IEC bus short command : SOUR2:SWE:STEP:LIN 1kHz
<b>DWELL</b>	Input value of the dwell time per step. IEC bus short command : SOUR2:SWE:DWEL 15ms
<b>SPACING</b>	Selection of the sweep run, linear or logarithmic. IEC bus short command : SOUR2:SWE:SPAC LIN
<b>MODE</b>	Selection of the sweep operating mode (cf. Section 2.8.3). IEC bus short command : SOUR2:FREQ:MODE SWE : SOUR2:SWE:MODE AUTO : TRIG2:S:SOUR OUR SING
<b>EXECUTE SINGLE SWEEP →</b>	Starts a single sweep run. This action to be executed is only indicated and is only effective if MODE SINGLE is selected. IEC bus short command : TRIG
<b>RESET SWEEP →</b>	Sets the starting frequency. IEC bus short command : ABOR
<b>MARKER 1 FREQ MARKER 2 FREQ MARKER 3 FREQ</b>	Input value of the frequency for the marker selected. IEC bus short command : SOUR2:MARK1:FREQ 1kHz
<b>MARKER 1 STATE MARKER 2 STATE MARKER 3 STATE</b>	Switching on/off the marker selected. IEC bus short command : SOUR2:MARK1 OFF

## 2.9 LIST Mode

A sequence of predefined frequency and level points is executed in the LIST mode, similar as in a sweep. Differently from the sweep, however, a list with freely selectable pairs of values (frequency and level) can be generated. The specified range of the frequency comprises the entire adjustable frequency range of the instrument. The specified range of the level covers a 20-dB range. If the permissible variation range is exceeded, the level error increases.

**Caution:** After the generation or change of a list in the LIST mode, function LEARN has to be started to ensure that the new settings are transferred to the hardware.

Table 2-6 LIST mode; Example of a list

Index	Frequency	Level
0001	100 MHz	0 dBm
0002	575 MHz	13 dBm
0003	235 MHz	7 dBm
0100	333 MHz	5 dBm
:	:	:

Up to 10 lists can be created. The total amount of possible pairs of values including all lists may maximally be 2000. I.e., a list may have 2000 entries at the most, or less if several lists have been created.

Each list is identified by a separate name and selected via this name. A detailed description how to process the lists can be found in Section 2.2.4, List Editor.

### 2.9.1 Operating Modes (MODE)

The following LIST-operating modes are available:

**AUTO** Run from the beginning to the end of the list with automatic restart at the beginning. If another mode was activated prior to the AUTO operating mode, continuation is made from the current index.

IEC bus short commands: :SOUR:FREQ:MODE LIST  
:SOUR:LIST:MODE AUTO  
:TRIG:LIST:SOUR AUTO

**SINGLE** Single run from the beginning to the end of the list. If SINGLE is selected, the run is not yet started. Function EXECUTE SINGLE LIST ► to be executed, which can be used to start the run, is displayed below the MODE line.

IEC bus short commands: :SOUR:FREQ:MODE LIST  
:SOUR:LIST:MODE AUTO  
:TRIG:LIST:SOUR SING

<b>STEP</b>	<p>Step-by-step manual processing of the list. Activating STEP stops a list running and the cursor wraps to the indication value of CURRENT INDEX. The list can now be controlled upwards or downwards in discrete steps using the rotary knob or the numeric keys.</p> <p>IEC bus short commands:   : SOUR:FREQ:MODE LIST                                          : SOUR:LIST:MODE STEP                                          : TRIG:LIST:SOUR SING</p>
<b>EXT-SINGLE</b>	<p>Single run from the beginning to the end of the list as with SINGLE, but triggered by an external trigger signal.</p> <p>IEC bus short commands:   : SOUR:FREQ:MODE LIST;                                          : SOUR:LIST:MODE AUTO                                          : TRIG:LIST:SOUR EXT</p>
<b>EXT-STEP</b>	<p>Step-by-step run by means of the external trigger signal. Each trigger event triggers a single step.</p> <p>IEC bus short commands:   : SOUR:FREQ:MODE LIST                                          : SOUR:LIST:MODE STEP                                          : TRIG:LIST:SOUR EXT</p>
<b>OFF</b>	<p>Operating mode LIST is switched off.</p> <p>IEC bus short command:   : FREQ:MODE CW</p>

## 2.9.2 Inputs/Outputs

TRIGGER input and BLANK output are available at the rear of the instrument for synchronization with other instruments.

<b>TRIGGER</b>	<p>An external signal at this input triggers the LIST mode in operating modes EXT-SINGLE and EXT-STEP. The polarity of the active trigger edge can be set in the UTILITIES - AUX I/O - EXT TRIG SLOPE menu.</p>
<b>BLANK</b>	<p>This output supplies a signal (0 V/5 V) to blank the settling process by means of pulse modulation or AM. The signal can also be used to synchronize other instruments. The polarity of the signal can be set in the UTILITIES - AUX I/O - BLANK POLARITY menu.</p>
<b>MARKER</b>	<p>At the first step of the LIST mode, this output provides an approx. 200 <math>\mu</math>s trigger signal immediately after blanking. At small DWELL times, this signal can be used for an accurate synchronization to trigger other devices and shows the first stable output frequency. The delay to the fed-in signal at the TRIGGER input for EXT-SINGLE or EXT-STEP is 1.5 to 2 ms and has a jitter of 0.5 ms.</p>

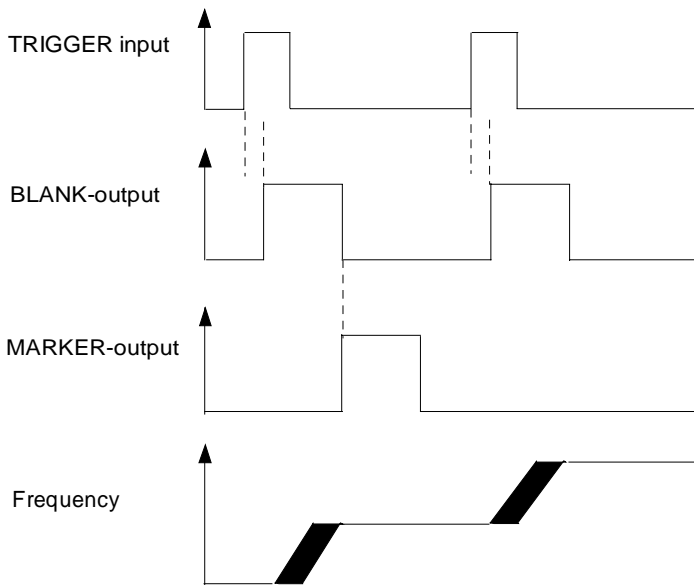

Fig. 2-58 Signal example LIST mode: MODE = EXT-STEP

The LIST menu offers access to settings for the LIST mode.

Menu selection: LIST

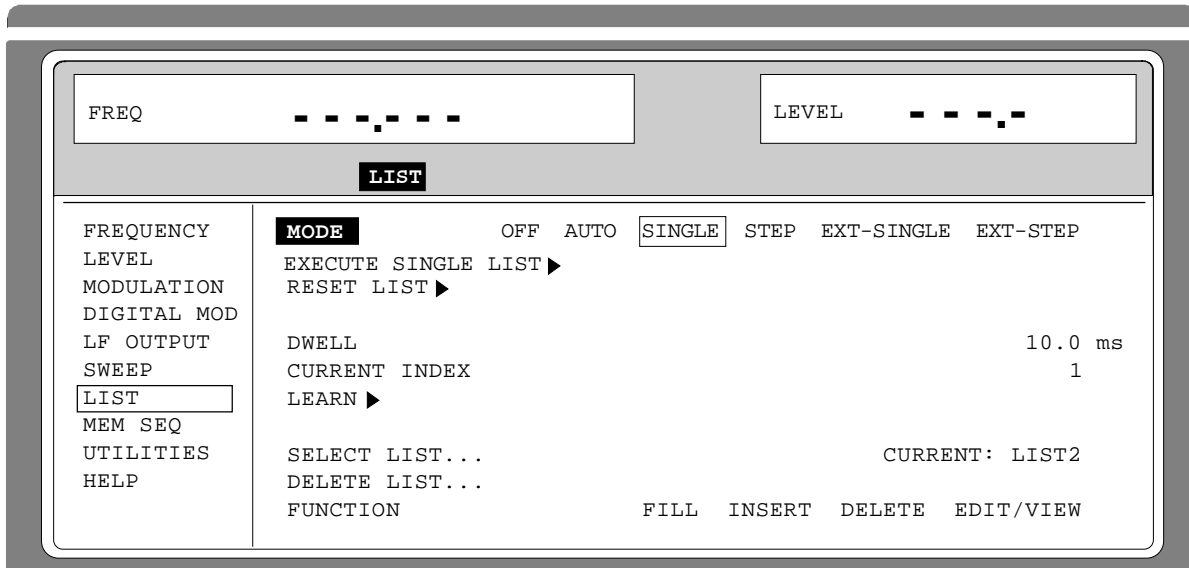

Fig. 2-59 Menu LIST - OPERATION page

**MODE** Selection of the operating mode (cf. Section 2.9.1, operating modes).

IEC bus short commands : :SOUR:FREQ:MODE LIST;  
 :SOUR:LIST:MODE AUTO;  
 :TRIG:LIST:SOUR SING

**EXECUTE SINGLE LIST →** Starts a single run of a list. This menu option is only visible if MODE SINGLE is selected.

IEC bus short command : :TRIG:LIST

---

<b>RESET LIST →</b>	Sets the starting point. IEC-bus short command : ABOR:LIST
<b>DWELL</b>	Input value of the dwell time per step. IEC-bus short command : SOUR:LIST:DWEL 10ms
<b>CURRENT INDEX</b>	Indication of the current list index. Setting value of the current list index in the STEP operating mode.
<b>LEARN →</b>	Starts the LEARN function. All value pairs of the active list are subsequently set by the instrument with the current additional parameters, and the hardware setting data are stored.  <b>Caution:</b> <i>This function must be called after every creating and altering the list (or the remaining setting data).</i> IEC-bus short command : SOUR:LIST:LEAR
<b>SELECT LIST...</b>	Selection of a list or creation of a new list (cf. Section 2.2.4, List Editor). IEC-bus short command : SOUR:LIST:SEL "LIST2"
<b>DELETE LIST...</b>	Deletion of a list (cf. Section 2.2.4, List Editor). IEC-bus short command : SOUR:LIST:DEL "LIST1"
<b>FUNCTION</b>	Selection of the editor functions to process a list (cf. Section 2.2.4, List Editor). IEC-bus short command :SOUR:LIST:FREQ 100MHz, 1.2GHz; POW 0dBm, 6dBm



The second page of the LIST menu, the EDIT page is automatically activated if one of the editor functions of line FUNCTION is selected. The list which is displayed as CURRENT LIST in the SELECT LIST line is shown.

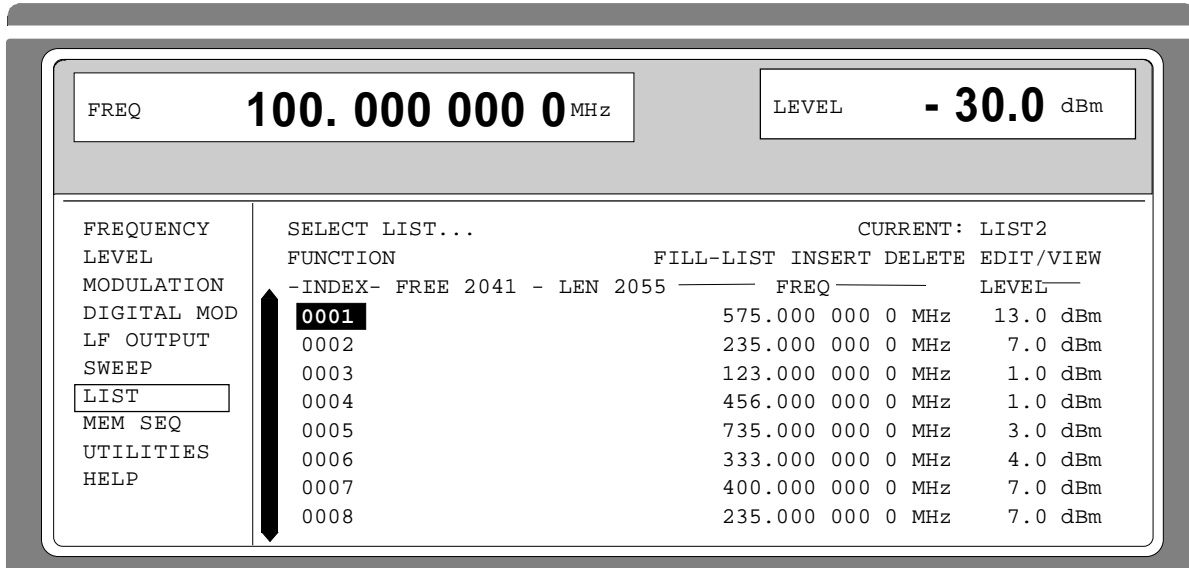

Fig. 2-60 Menu List - EDIT page

- INDEX** Index of the list.
- FREE** Indication of the list entries still vacant.
- LENGTH** Length of the current list.
- FREQ** Parameter: Frequency.
- LEVEL** Parameter: Level; specified range 20 dB.

## 2.10 Memory Sequence

In the memory-sequence operating mode the instrument automatically services a list with stored instrument settings. Memory locations 1 to 50, which are loaded using SAVE and whose stored settings are called either separately using RECALL or automatically and subsequently in the SEQUENCE mode, are available.

The list is continuously serviced from the beginning to the end with a continual index. The order of the memories to be passed through is arbitrary. Each setting can be assigned a freely selectable dwell time. The dwell time determines the duration of the setting, its minimal value is 50 ms, its maximal value 60 sec.

The list is divided up into 3 columns for list index, memory location number (Memory) and dwell time (Dwell) .. The beginning of the list has index 1.

Table 2-7 MEMORY SEQUENCE; Example of a list

Index	Memory	Dwell
001	09	50.0 ms
002	02	50.0 ms
003	01	75.0 ms
004	10	75.0 ms
...	...	...

Up to 10 sequence lists can be created. The total number of possible list elements is maximally 256. I.e., a list can have 256 entries at the most, or less if several lists have been created.

Each list is identified by a separate name and selected via this name. A detailed description how to process the lists can be found in Section 2.2.4, List Editor.

**Note:** *Frequently changing the level in the operating mode MEMORY SEQUENCE can stress the mechanically switched attenuator. The attenuator is also actuated when AM is switched on or off. For this reason we recommend that you make use of the non-interrupting level setting as much as possible and that you use the setting AM 0% instead of switching AM off.*

### Operating Modes (MODE)

The following operating modes are available:

#### AUTO

Run from the beginning to the end of the list with automatic restart at the beginning. If another mode was activated prior to the AUTO operating mode, continuation is made from the current index.

IEC-bus short command:   :SYST:MODE MSEQ;  
                               :SYST:MSEQ:MODE AUTO  
                               :TRIG:MSEQ:SOUR AUTO

---

<b>SINGLE</b>	<p>Single run from the beginning to the end of the list. If SINGLE is selected, the run is not yet started. Below the MODE line, function EXECUTE SINGLE SEQUENCE ► to be executed is displayed which can be used to start the run.</p> <p>IEC-bus short command     : SYST:MODE MSEQ;                               : SYST:MSEQ:MODE AUTO                               : TRIG:MSEQ:SOUR SING</p>
<b>STEP</b>	<p>Step-by-step manual processing of the list. Activating STEP stops an automatic run and the cursor wraps to the indication value of CURRENT INDEX. The list can now be passed through upwards or downwards step by step using the rotary knob.</p> <p>IEC-bus short command     : SYST:MODE MSEQ;                               : SYST:MSEQ:MODE STEP                               : TRIG:MSEQ:SOUR SING</p>
<b>EXT-SINGLE</b>	<p>Single run from the beginning to the end of the list as with SINGLE, but triggered by an external trigger signal.</p> <p>IEC-bus short command     : SYST:MODE MSEQ;                               : SYST:MSEQ:MODE AUTO                               : TRIG:MSEQ:SOUR EXT</p>
<b>EXT-STEP</b>	<p>Step-by-step run using the external trigger signal. Each trigger event triggers a single step.</p> <p>IEC-bus short command     : SYST:MODE MSEQ;                               : SYST:MSEQ:MODE STEP                               : TRIG:MSEQ:SOUR EXT</p>
<b>OFF</b>	<p>Step-by-step run using the external trigger signal. Each trigger event triggers a single step.</p> <p>IEC-bus short command     : SYST:MODE FIX</p>

## External Trigger

An external signal at the rear input TRIGGER triggers the MEMORY SEQUENCE in the EXT-SINGLE and EXT-STEP operating modes. The polarity of the active trigger edge can be set in the UTILITIES - AUX I/O - EXT TRIG SLOPE menu.

Menu MEM SEQ with the two menu pages OPERATION and EDIT offers access to the memory-sequence operating mode.

Menu selection: MEM SEQ

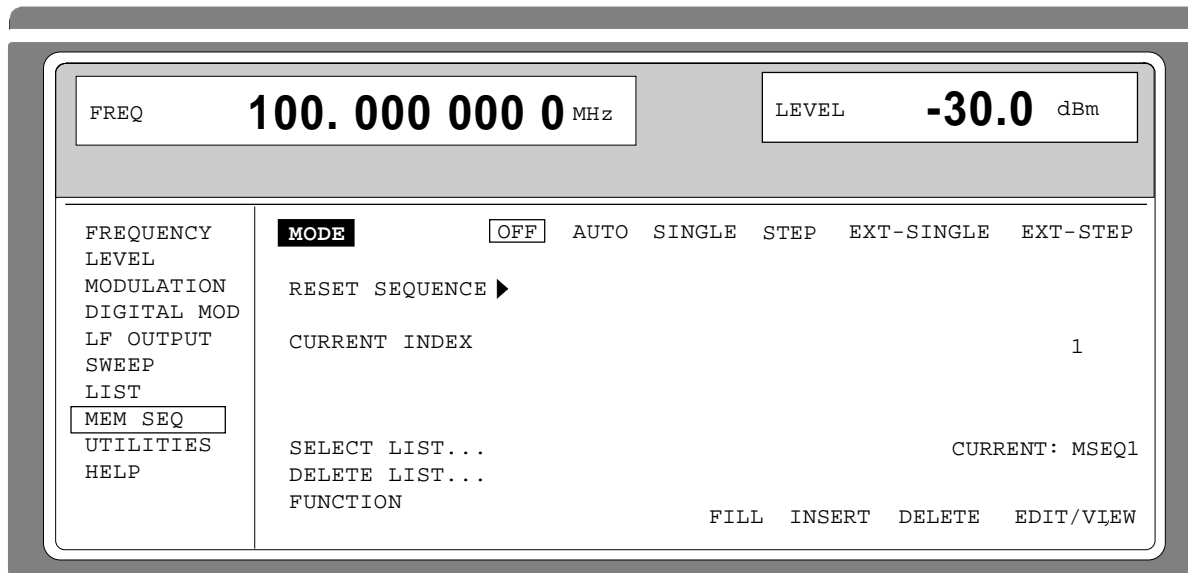

Fig. 2-61 Menu MEM SEQ -OPERATION- page (preset setting)

<b>MODE</b>	Selection of the operating mode; setting the operating mode regards various command systems at the IEC bus (cf. above).
<b>EXECUTE SINGLE SEQUENCE →</b>	Starts the single run of a memory sequence. This menu option is only visible if MODE SINGLE is selected. IEC-bus short command :TRIG:MSEQ
<b>RESET SEQUENCE →</b>	Wrap to the beginning of the list. IEC-bus short command :ABOR:MSEQ
<b>CURRENT INDEX</b>	Indication of the current list index. Setting value of the current list index in the MODE STEP operating mode.
<b>SELECT LIST...</b>	Selection of a list or generation of a new list (cf. Section 2.2.4, List Editor). IEC-bus short command :SYST:MSEQ:SEL "MSEQ1"
<b>DELETE LIST...</b>	Deletion of a list (cf. Section 2.2.4, List Editor). IEC-bus short command :SYST:MSEQ:DEL "MSEQ2"
<b>FUNCTION</b>	Selection of the editor functions to process a list (cf. Section 2.2.4, List Editor). IEC-bus short command :SYST:MSEQ 9,2,...; :SYST:MSEQ:DWEL 50ms, 50ms,.

The second page of menu MEM SEQ, the EDIT page, is automatically activated if one of the editor functions of the FUNCTION line is selected. The list which is entered as CURRENT LIST in the SELECT LIST line is shown.

The screenshot shows the MEM SEQ - EDIT page. At the top, there are two display boxes: 'FREQ 100.000 000 0 MHz' and 'LEVEL -30.0 dBm'. Below these is a table with columns for 'FUNCTION', 'MEMORY', and 'DWELL'. The 'FUNCTION' column lists various settings like INDEX, FREE, LEN, etc. The 'MEMORY' column shows values from 09 to 11. The 'DWELL' column shows values from 50 ms to 85 ms. A vertical cursor is positioned over the '001' value in the 'MEMORY' column.

FUNCTION	MEMORY	DWELL
-INDEX - FREE 2041 - LEN 2055		
001	09	50 ms
002	02	50 ms
003	01	60 ms
004	23	60 ms
005	09	85 ms
006	10	85 ms
007	08	85 ms
008	11	85 ms

Fig. 2-62 Menu MEM SEQ - EDIT page

<b>INDEX</b>	Index of the list.
<b>FREE</b>	Indication of the list entries still vacant.
<b>LEN</b>	Length of the current list.
<b>MEMORY</b>	Parameter: number of memory location; range 1 to 50.
<b>DWELL</b>	Parameter: dwell time; specified range 50 ms to 60 sec, step width 1 ms.

## 2.11 Utilities

The UTILITIES menu contains submenus for general functions which do not directly relate to the signal generation.

### 2.11.1 IEC-Bus Address (SYSTEM-GPIB)

Submenu SYSTEM-GPIB offers access to the remote-control address. The setting range is 0 to 30. At the point of delivery address 28 is set.

Menu selection: UTILITIES -SYSTEM -GPIB

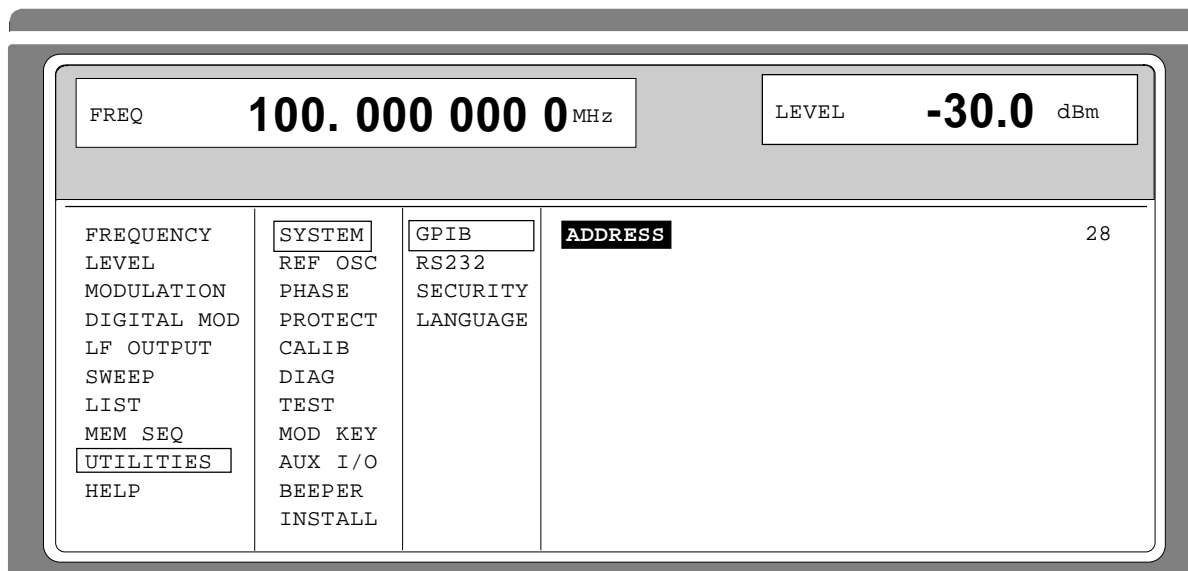

Fig. 2-63 Menu UTILITIES -SYSTEM -GPIB

**ADDRESS** Input value of the IEC-bus address  
 IEC-bus short command :SYST:COMM:GPIB:ADDR 28

### 2.11.2 Parameter of the RS232 Interface (SYSTEM-RS232)

Submenu SYSTEM-RS232 offers access to the configuration of the RS-232 interface. The pin assignment of the interface corresponds to the pin assignment of a PC.

Menu selection: UTILITIES - SYSTEM - RS232

FREQ		100.000 000 0 MHz		LEVEL		-30.0 dBm	
FREQUENCY	SYSTEM	GPIB	<b>DATA FORMAT</b>	8 Bits			
LEVEL	REF OSC	RS232	PARITY	NO			
MODULATION	PHASE	SECURITY	STOP BIT	1			
DIGITAL MOD	PROTECT	LANGUAGE	BAUD RATE	9600		bps	
LF OUTPUT	CALIB		HANDSHAKE	OFF	RTS/CTS	XON/XOFF	
SWEEP	DIAG						
LIST	TEST						
MEM SEQ	MOD KEY						
UTILITIES	AUX I/O						
HELP	BEEPER						
	INSTALL						

Fig. 2-64 Menu UTILITIES - SYSTEM - RS232

**DATA FORMAT** Indication of the number of data bits. This value cannot be changed.

**PARITY** Indication of parity. This value cannot be changed.

**STOP BIT** Indication of the number of stop bits. This value cannot be changed.

**BAUD RATE** Selection of the baud rate.  
IEC-bus short command : SYST:COMM:SER:BAUD 9600

**HANDSHAKE** Selection of the handshake.  
OFF No handshake  
IEC-bus short command : SYST:COMM:SER:PACE NONE  
: SYST:COMM:SER:CONT:RTS ON

RTS/CTS Hardware handshake using the interface lines RTS and CTS. This mode always is to be preferred to XON/XOFF mode, if permitted by the configuration of the host computer.

IEC-bus short command : SYST:COMM:SER:CONT:RTS RFR

XON/XOFF Software handshake using the ASCII codes 11h <XON> and 13h <XOFF>. This mode is not recommended for binary data and for baud rates above 9600 baud.

IEC-bus short command : SYST:COMM:SER:PACE XON

### 2.11.3 Suppressing Indications and Deleting Memories (SYSTEM-SECURITY)

For security interests, indications can be suppressed and memories deleted in the SYSTEM-SECURITY submenu.

Menu selection: UTILITIES - SYSTEM-SECURITY

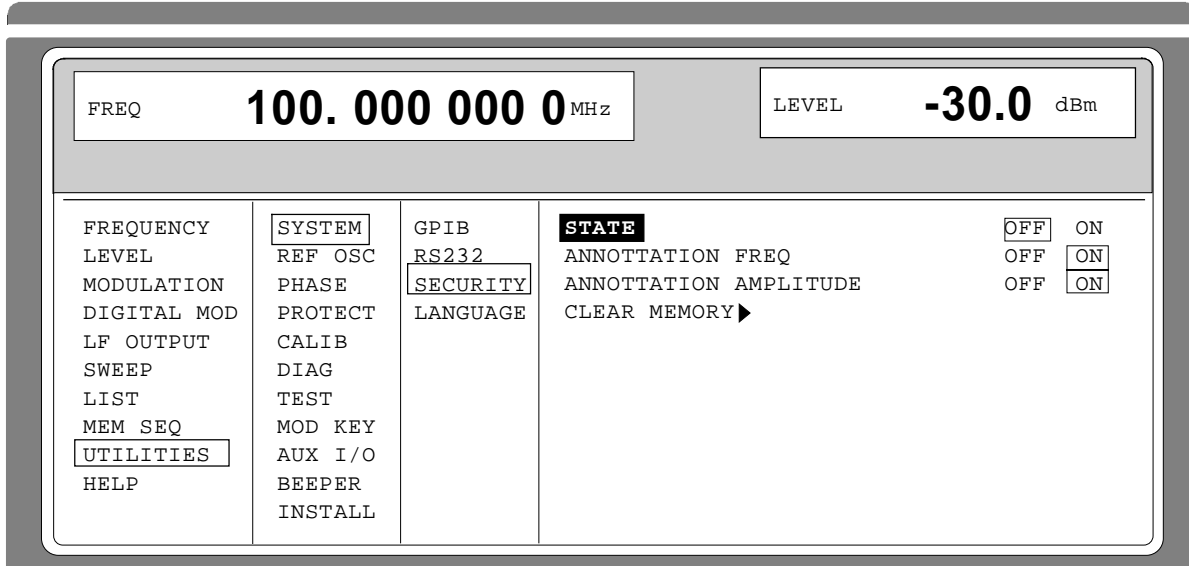

Fig. 2-65 Menu UTILITIES - SYSTEM-SECURITY

<b>STATE</b>	Selection of the SECURITY state
ON	Locks the suppression of the indications. Can only be set via IEC bus.
OFF	Deactivates the interlock of the indication suppression. The preset state is set in the transition ON→OFF, and all data stored such as settings, with the exception of the DM lists are deleted. Can only be set via IEC bus.
	IEC-bus short command :SYST:SEC OFF
<b>ANNOTTATION FREQ</b>	OFF All frequency indications are suppressed.
	ON The frequency setting is displayed..
	IEC-bus short command :DISP:ANN:FREQ ON
<b>ANNOTTATION AMPLITUDE</b>	OFF All level indications are suppressed.
	ON The level setting is displayed.
	IEC-bus short command :DISP:ANN:AMPL ON
<b>CLEAR MEMORY →</b>	Deletion of all data stored such as settings, user correction and list settings stored, with the exception of the DM lists.
	For this action, two commands are necessary at the IEC bus:
	IEC-bus short command :SYST:SEC ON; SEC OFF



### 2.11.4 Indication of the IEC-Bus Language (LANGUAGE)

Submenu UTILITIES-SYSTEM LANGUAGE indicates the IEC-bus language and the current SCPI version.

### 2.11.5 Reference Frequency Internal/External (REF OSC)

In the internal-reference operating mode, the internal reference signal at a frequency of 10 MHz is available at the REF socket (rear of the instrument).

Signal level:  $V_{\text{eff}}$  (EMF, sine) = 1 V.

The frequency of the internal reference oscillator can be detuned via the TUNE input (rear of the instrument). Input voltage range  $\pm 10$  V, pulling range  $\pm 1 \times 10^{-6}$ .

The external detuning is possible in both states of the ADJUSTMENT STATE (ON or OFF) unless option SM-B1, reference oscillator OCXO, is fitted. If option SM-B1, reference oscillator OCXO, is fitted, the detuning via the TUNE input is only possible if the ADJUSTMENT STATE selection has been switched to ON in the UTILITIES-REF OSC menu.

In the external-reference operating mode, an external signal at a frequency of 1 MHz to 16 MHz (spacing 1 MHz) is to be fed into socket REF. The setting to external frequency is effected in the UTILITIES-REF OSC menu.

Signal level:  $V_{\text{eff}} = 0.1$  to 2 V

The message "EXT REF" is displayed in the status line in the header field of the display in the external-reference operating mode.

Menu selection: UTILITIES - REF OSC

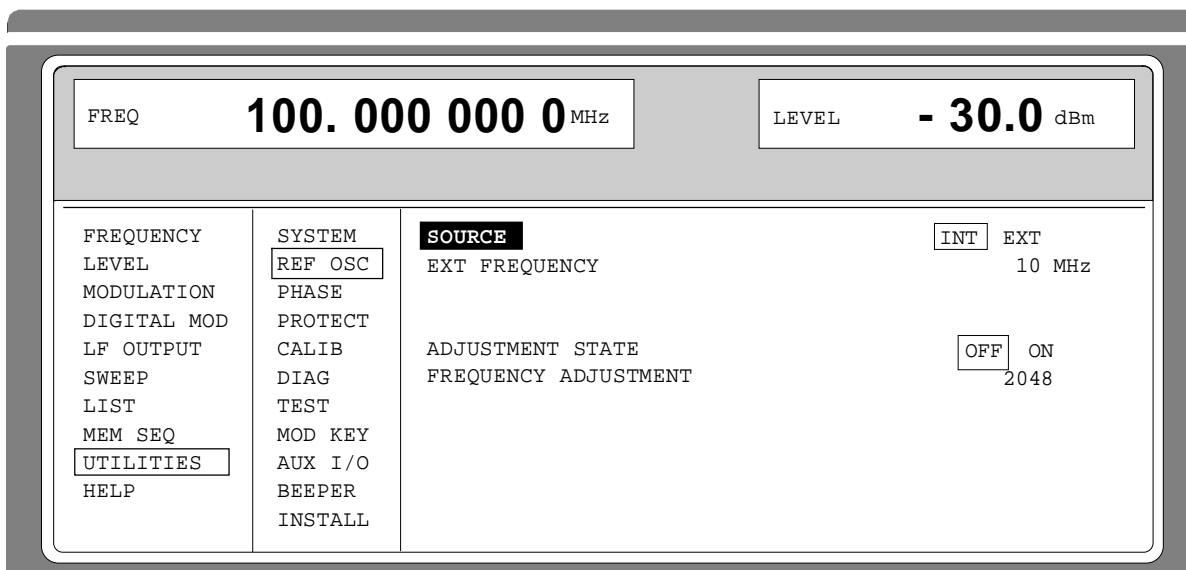

Fig. 2-66 Menu UTILITIES - REF OSC (preset setting)

#### SOURCE

Selection of the operating mode.

INT Internal-reference operating mode

EXT External-reference operating mode

IEC-bus short command : SOUR:ROSC:SOUR INT

<b>EXT FREQUENCY</b>	Input value of the external reference frequency (1 MHz to 16 MHz, spacing 1 MHz). IEC-bus short command : SOUR:ROSC:EXT:FREQ 10E6
<b>ADJUSTMENT STATE</b>	<p>OFF Tuning value of the internal reference frequency as calibrated (cf. menu UTILITIES-CALIB)</p> <p>ON Tuning value according to setting value FREQUENCY ADJUSTMENT. Option SM-B1, reference oscillator OCXO, is switched off. Only the standard reference oscillator is in operation.</p> <p>IEC-bus short command : SOUR:ROSC:ADJ:STAT ON</p>
<b>FREQUENCY ADJUSTMENT</b>	Input value in the range 0 to 4095 to set the internal reference frequency. Pulling range $\pm 4 \times 10^{-6}$ IEC-bus short command : SOUR:ROSC:ADJ:VAL 2048

### 2.11.6 Phase of the Output Signal (PHASE)

Menu UTILITIES-PHASE offers access to the phase setting of the RF output signal with respect to a reference signal of the same frequency.

Menu selection: UTILITIES - PHASE

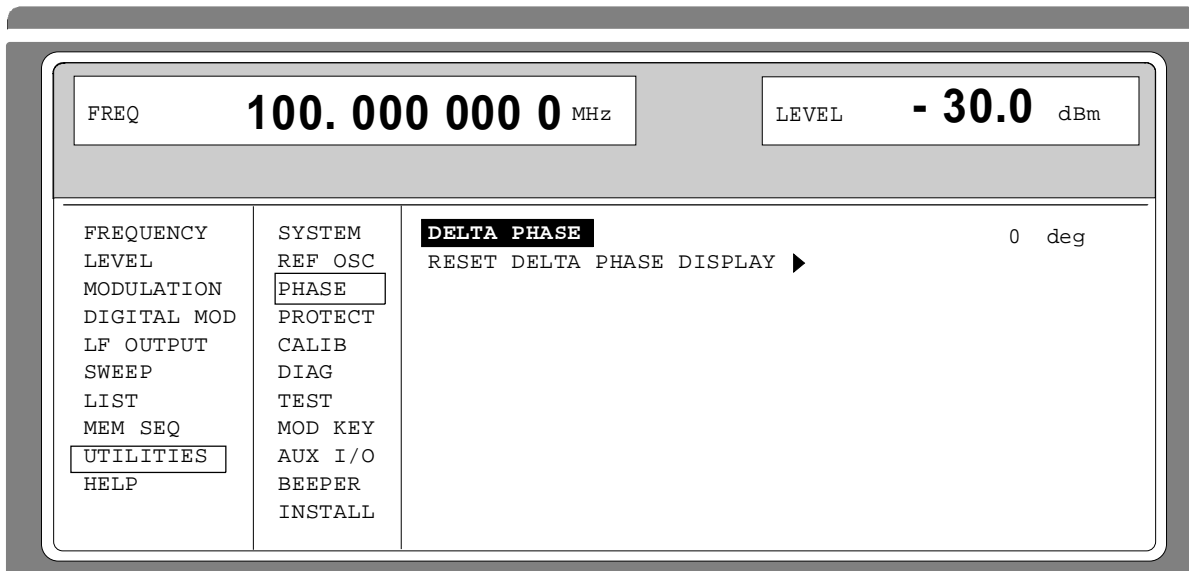

Fig. 2-67 Menu UTILITIES - PHASE (preset setting)

<b>DELTA PHASE</b>	Setting value of the phase. IEC-bus short command : SOUR:PHAS 0
<b>RESET DELTA PHASE DISPLAY →</b>	Sets the display of the DELTA PHASE to 0 without the phase of the output signal being influenced. IEC-bus short command : SOUR:PHAS:REF

### 2.11.7 Password Input With Functions Protected (PROTECT)

The execution of calibrating and service functions is protected by a password. To unlock the lock-out, the correct password, a 6-digit number, has to be entered and then the [ENTER] key has to be pushed. After the instrument has been switched on, the lock-out is automatically activated.

Password 1 unlocks the lock-out for calibrations LEV PRESET, VCO SUM and PULSE GEN.

Password 2 unlocks the lock-out for calibration REF OSC.

Password 3 permits the input of the serial number and the value of the counter for POWER ON, operating hours and attenuator circuits.

Menu UTILITIES-PROTECT offers access to the unlocking of protected functions.

Menu selection: UTILITIES - PROTECT

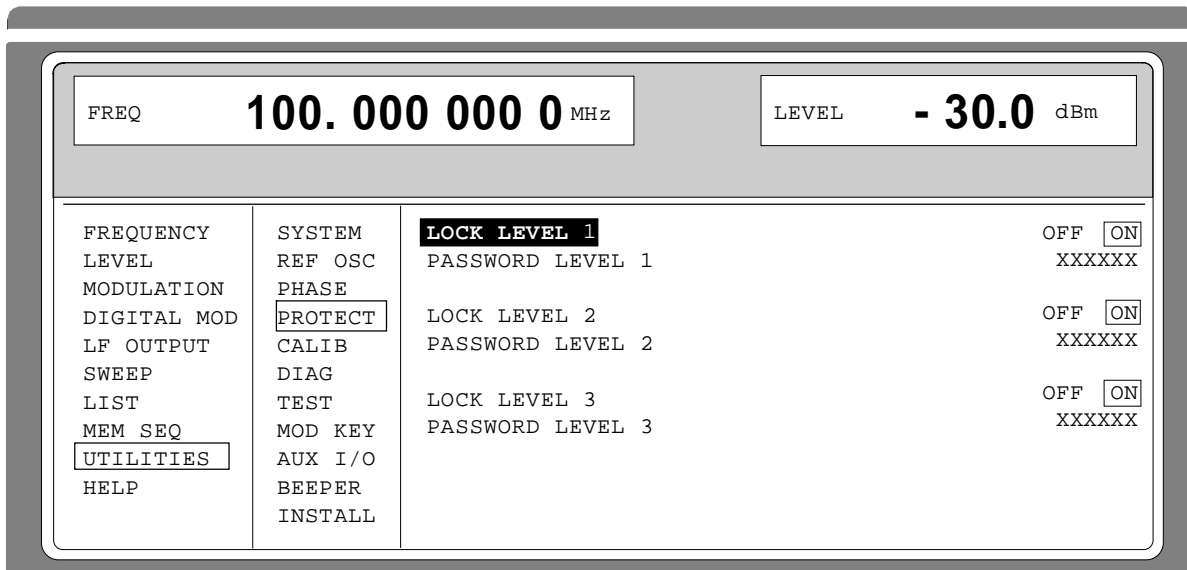

Fig. 2-68 Menu UTILITIES - PROTECT (preset setting)

#### LOCK LEVEL x

Activating/deactivating the lock-out.

ON The lock-out is activated.

OFF The cursor automatically wraps to the input of the password. After the password has been entered, the lock-out is deactivated.

IEC-bus short command :SYST:PROT1 ON

#### PASSWORD LEVEL x

Input of the password; termination with [ENTER] key.

IEC-bus short command :SYST:PROT1 OFF, 123456

### 2.11.8 Calibration (CALIB)

For servicing, the following menus offer access to calibrating routines and correction values:

```

UTILITIES - CALIB -  VCO SUM
                    LEV PRESET
                    PULSE GEN
                    REF OSC   (cf. service manual)
                    QPSK
                    LEVEL     (cf. service manual)
    
```

Internal calibration routines LEV PRESET, VCO SUM, QPSK and PULSE GEN are protected by a password. They can only be executed if the lock-out in the UTILITIES - PROTECT menu has been unlocked. The password is PASSWORD LEVEL 1 = "123456".

**Caution:** Execute calibration routines only when the instrument has warmed up

Calibration routines LEVEL and REF OSC are described in the service manual (stock no. 1039.1856.24).

#### Calibration VCO SUM

To synchronize the summing loop, the frequency the oscillator generates must be so close to the rated frequency that the phase control can lock in. This is effected by means of presetting values. The presetting values are stored in a table and can be renewed using internal calibration routine VCO SUM. The calibration routine needs only be executed after a data loss in the RAM or after an exchange of modules.

**Function:** In a 10-MHz division scale, the VCOs are synchronized with the rated frequency and the presetting voltage readjusted until the difference to the tuning voltage becomes minimal. The value hence achieved is entered into the table. The routine takes approx. 10 seconds.

Menu selection: UTILITIES - CALIB - VCO SUM

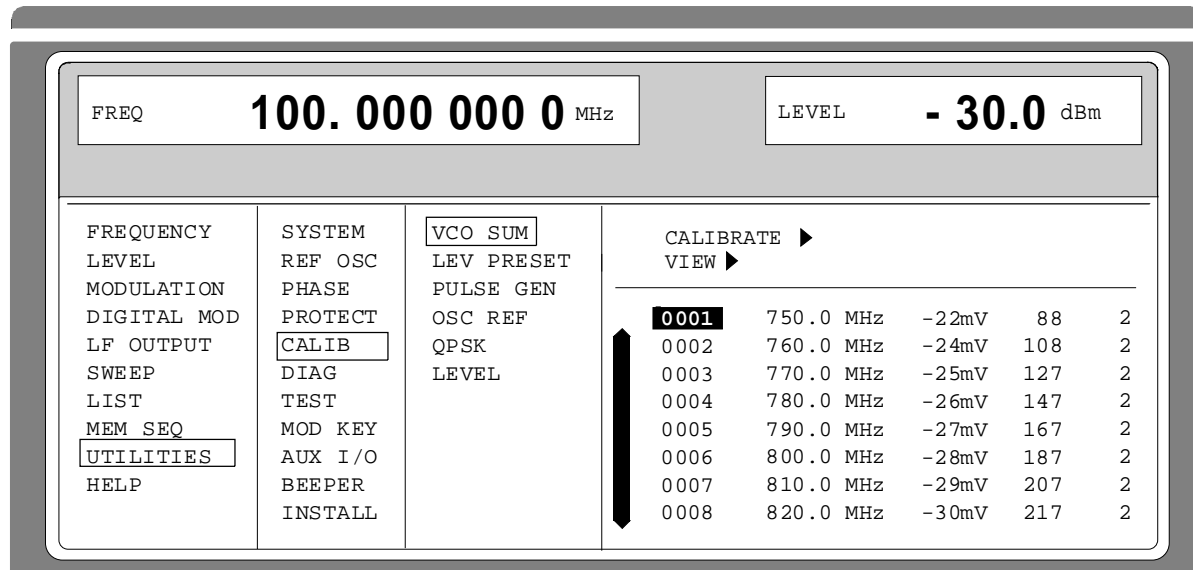

Fig. 2-69 Menu UTILITIES - CALIB - VCO SUM

**CALIBRATE →** Triggers the calibration for the VCO summing loop  
 IEC-bus short command :CAL:VSUM?

**VIEW →** Indication of the list of correction values.  
 The cursor wraps to index 1 of the list. The list can be executed using the rotary knob. This index can be obtained by entering the index value on the digit block.  
 IEC-bus short command :CAL:VSUM:OFFS?  
 :CAL:VSUM:DAC?  
 :CAL:VSUM:KOS?

**Calibration LEV PRESET**

In order to hold the amplitude modulator in the optimal working point with all frequency and level settings, a second control element is mounted by means of which the level before the modulator is set in such a way that the modulator always works in the best part of its characteristic. The setting values for the second control element are stored in a table and can be renewed using internal calibration routine LEV PRESET. The calibration routine needs only be executed in the case of a data loss in the RAM or after an exchange of modules.

**Function:** By alternately adjusting the two level control elements, the calibration routine determines the value for the presetting in which the amplitude modulator is operated at the attenuation demanded. The calibration is executed according to a given frequency table at levels of 13dBm to -2dBm in steps of 3 dB. The routine takes approx. 2 min.

Menu selection: UTILITIES - CALIB - LEV PRESET

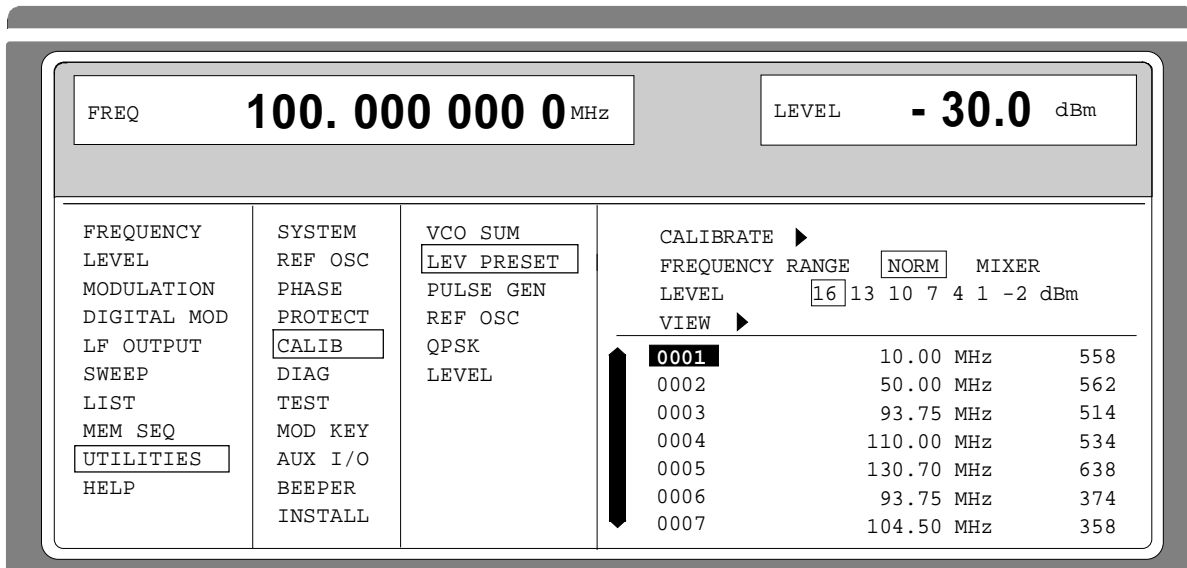

Fig. 2-70 Menu UTILITIES - CALIB - LEV PRESET

**CALIBRATE →** Triggers the calibration for level preset.  
 IEC-bus short command :CAL:LPR?

**FREQUENCY RANGE** Selection of the correction values displayed by VIEW  
 NORM Correction values, with the exception of the mixer range.  
 MIXER Correction values of the mixer range.

- LEVEL** Selection of the level for which the correction values are indicated.
- VIEW →** The cursor wraps to index 1 of the list. The list can be executed using the rotary knob. This index can be directly obtained by entering the index value on the digit block.  
IEC-bus short command : CAL : LPR : DATA?

**Calibration PULSE GEN**

A programmable oscillator determines the accuracy of the pulse width and the pulse delay of the pulse generator. To compensate for the temperature dependence of the oscillator (approx. 0.2%/degree) an internal calibration is offered. The adjustment accuracy is approx. ±0.5%. The calibration routine is to be executed even after a data loss in the RAM or after an exchange of modules.

**Function:** The frequency of the oscillator is measured using a counter which is synchronized with the crystal reference. The oscillator is readjusted until the deviation is minimized. The calibration value thus achieved is stored.

Menu selection: UTILITIES - CALIB - PULSE GEN

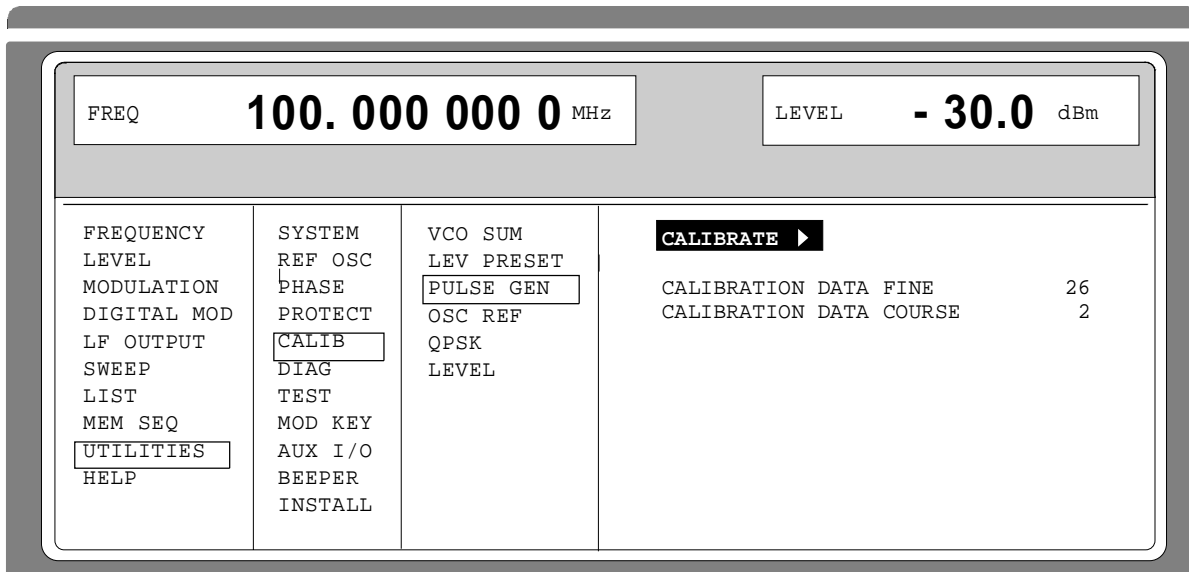

Fig. 2-71 Menu UTILITIES - CALIB - PULSE GEN

- CALIBRATE →** Triggers the calibration for the pulse generator.  
IEC-bus short command : CAL : PULS?
- CALIBRATION DATA FINE** Indication of the fine adjustment in decimal form.  
IEC-bus short command : CAL : PULS : DATA?
- CALIBRATION DATA COURSE** Indication of the coarse adjustment in decimal form.  
IEC-bus short command : CAL : PULS : DATA?

## CALIBRATION QPSK

QPSK modulation is generated by means of frequency modulation and amplitude modulation. The delay of FM and AM signal must be tuned to each other. As the delay of the AM signal is subjected to manufacturing tolerances, the delay of the FM signal can be adjusted electronically.

Menu UTILITIES-CALIB-QPSK offers access to the delay calibration. The delay can be set in the range 0 to 10  $\mu$ s in steps of 20 ns. The delay is set correctly if the spectrum of the PRBS-modulated QPSK signal at the RF output is symmetric. The typical value of the delay is 2.60  $\mu$ s.

**Menu selection:** UTILITIES - CALIB - QPSK

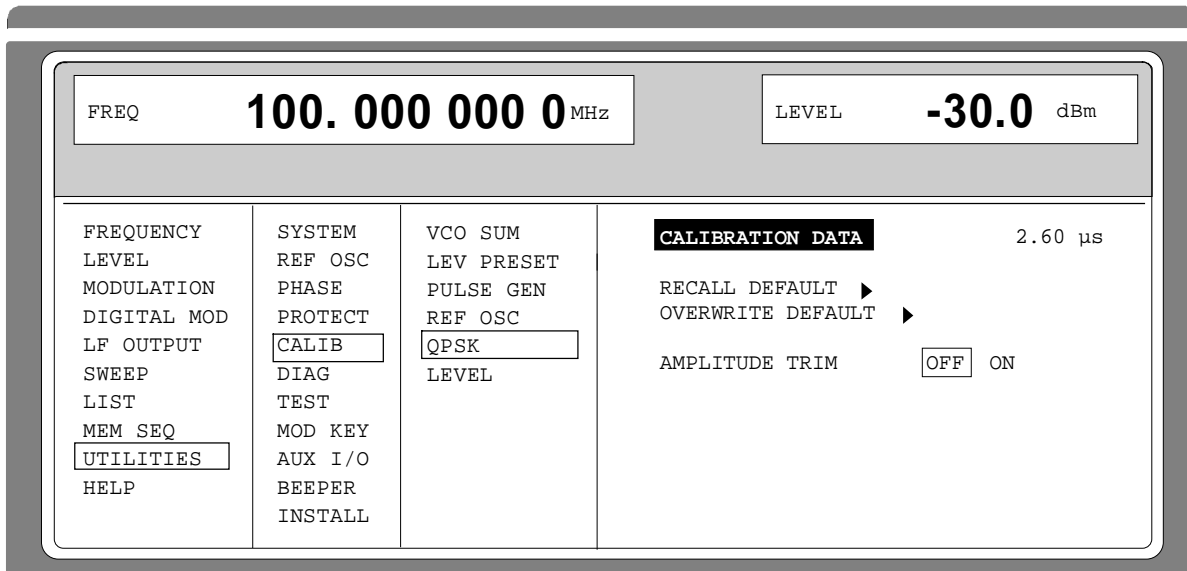

Fig. 2-72 Menu UTILITIES - CALIB - QPSK

### CALIBRATION DATA

Input value of the delay compensation.

IEC-bus short command :CAL:QPSK 2.60us

### RECALL DEFAULT →

Sets the DEFAULT value (factory setting).

IEC-bus short command :CAL:QPSK DEF

### OVERWRITE DEFAULT →

Overwrites the DEFAULT value in the Flash-EEPROM with the current DELAY value. The function is protected by PASSWORD LEVEL 2.

IEC-bus short command :CAL:QPSK:STOR

### AMPLITUDE TRIM

Switches on/off the service function for the adjustment of the amplitude content with QPSK.

**Note:** If the service function "AMPLITUDE TRIM" is switched on, this is indicated by displaying "QPSK AMPLITUDE TRIM" in the status line. An activated AM is deactivated by switching on AMPLITUDE TRIM.

### 2.11.9 Indications of Module Variants (DIAG-CONFIG)

For service purposes, the modules installed can be indicated with their variants and states of modification. Submenu DIAG-CONFIG offers access to the module indication.

IEC-bus short command :DIAG:INFO:MOD?

Menu selection: UTILITIES - DIAG - CONFIG

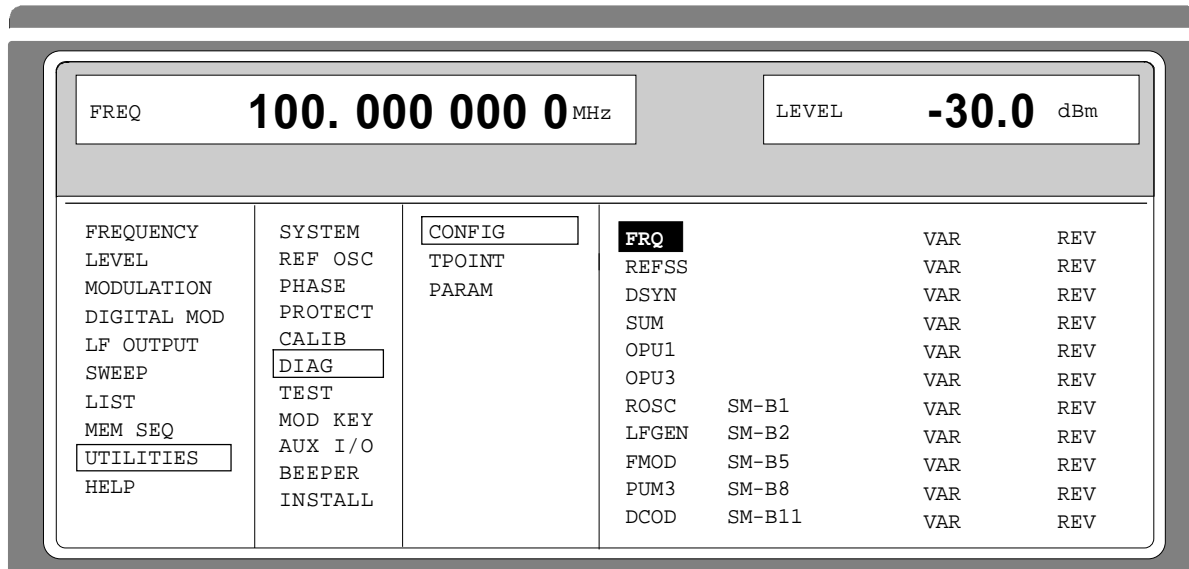

Fig. 2-73 Menu UTILITIES - DIAG - CONFIG



### 2.11.10 Voltage Indication of Test Points (DIAG-TPOINT)

Submenu DIAG-TPOINT offers access to internal test points. If a test point is switched on, the voltage indication is displayed in a window in the header field. For greater detail, see service manual (stock no. 1039.1856.24).

Menu selection: UTILITIES - DIAG - TPOINT

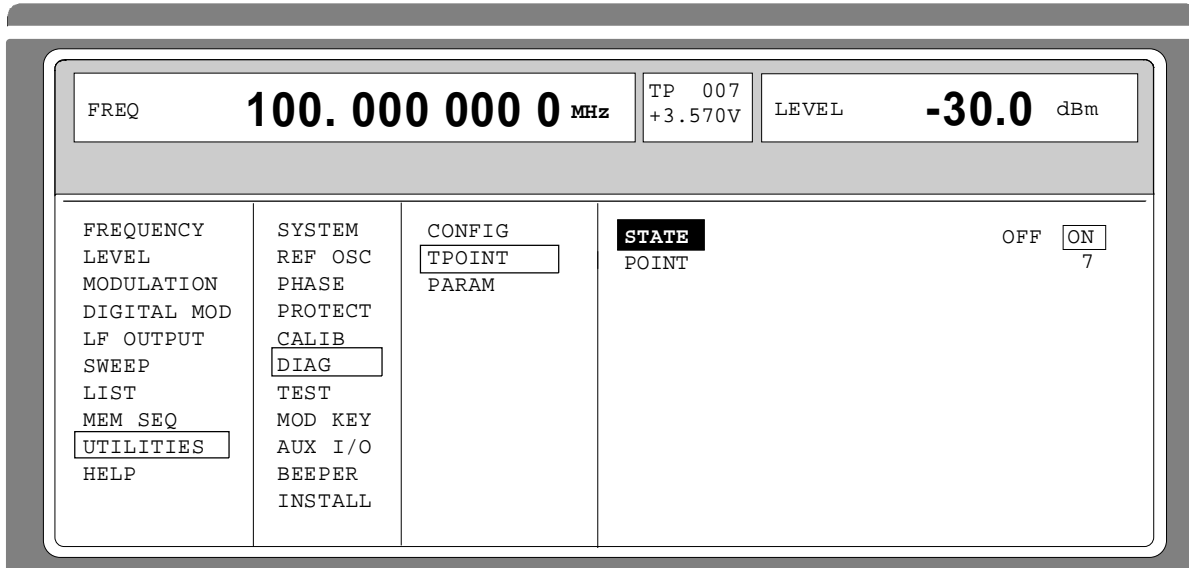

Fig. 2-74 Menu UTILITIES - DIAG - TPOINT

**STATE** Switching on/off the voltage indication in the headerfield.

**POINT.....** Input value of the test point.  
IEC-bus short command :DIAG:POINxx?

### 2.11.11 Indications of Service Data (DIAG-PARAM)

Submenu DIAG-PARAMETER offers access to different parameters such as serial number, software version, operating-hours counter and attenuator circuits.

Menu selection: UTILITIES - DIAG - PARAM

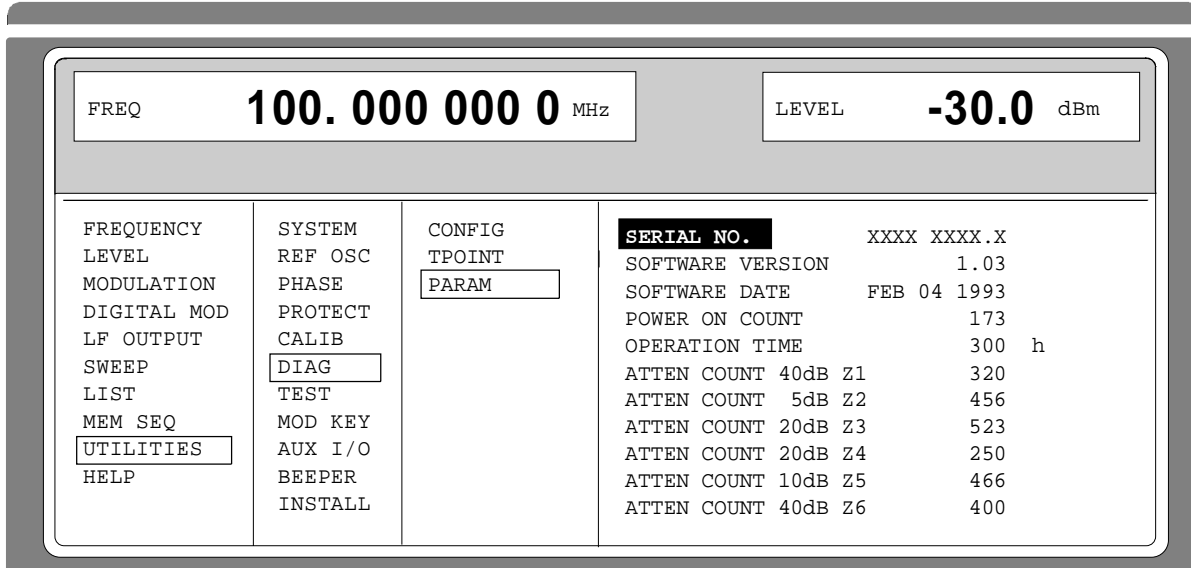

Fig. 2-75 Menu UTILITIES - DIAG - PARAM

For IEC-bus commands, cf. Chapter 3, Section "DIAGnostic System".

### 2.11.12 Test (TEST)

(cf. Chapter 4, Section "Functional Test")

### 2.11.13 Assigning Modulations to the [MOD ON/OFF] Key (MOD-KEY)

The modulations can be switched on/off in the individual modulation menus and parallelly by means of the [MOD ON/OFF] key.

For which modulations the [MOD ON/OFF] key is effective can be defined in the UTILITIES-MOD KEY menu. The key can either be effective for all modulations or for a selected one.

Function of the [MOD ON/OFF] key if effective for a type of modulation:

- Every pressing a key alters the state (ON or OFF) of the selected modulation.

Function of the [MOD ON/OFF] key if effective for all types of modulation (ALL):

- If at least one modulation is switched on, pressing the [MOD ON/OFF] key switches the modulation/s off. Which modulations were switched on is stored.

If no modulation is switched on, pressing the [MOD ON/OFF] key switches on the modulations which were last switched off using the [MOD ON/OFF] key.

On switching on using the [MOD ON/OFF] key, the modulation sources are used as defined in the modulation menus.

Access to the selection of the modulation to be switched using the [MOD ON/OFF] key is possible in the UTILITIES-MOD KEY menu.

Menu selection: UTILITIES - MOD KEY

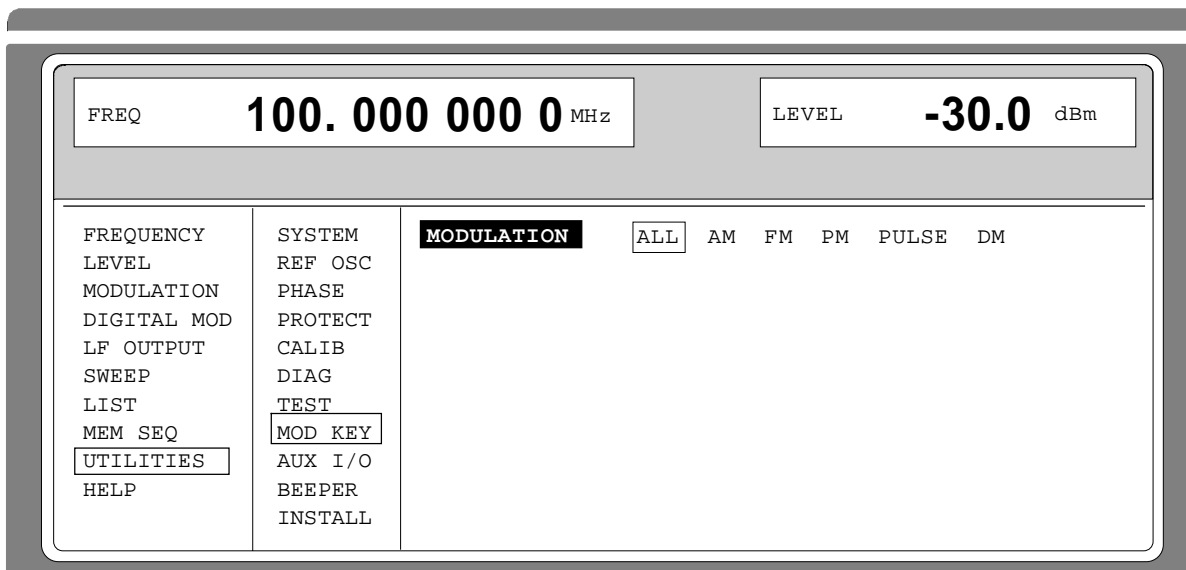

Fig. 2-76 Menu UTILITIES - MOD KEY (preset setting)

#### MODULATION

Selection for which modulation the [MOD ON/OFF] key is to be effective.

**Note:** Preset switches off all modulations, sets the selection to ALL and stores AM 30%, AM SOURCE INT: LF GEN1 as default setting.

### 2.11.14 Setting Auxiliary Inputs/Outputs (AUX-I / O)

Menu UTILITIES - AUX I/O offers access to settings for the TRIGGER input, BLANK output and MARKER output. Sections Sweep, List Mode and Memory Sequence provide further information.

Menu selection: UTILITIES - AUX I/O

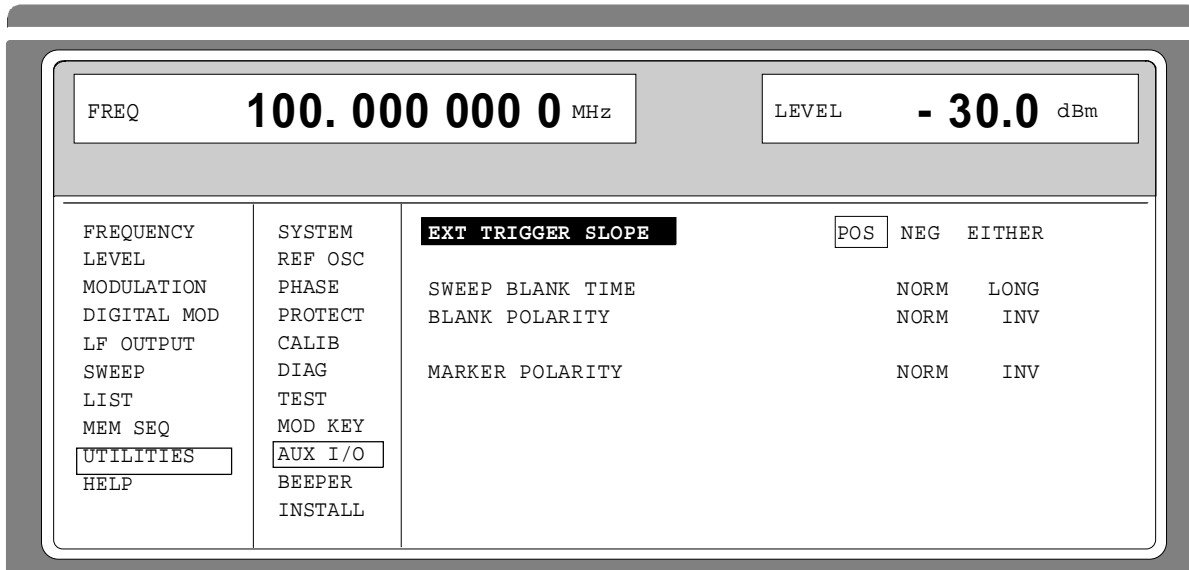

Fig. 2-77 Menu UTILITIES - AUX I/O

#### EXT TRIGGER SLOPE

Selection of the active edge of the external trigger signal.

- POS The instrument triggers on the positive edge of the external signal.
- NEG The instrument triggers on the negative edge of the external signal.
- EITHER The instrument triggers on both edges of the external signal.

IEC-bus short command :TRIG:SLOP POS

#### SWEEP BLANK TIME

Selection of the blank duration.

- NORM BLANK duration is set to the shortest duration possible.
- LONG The BLANK duration is set for the PEN LIFT control of an XY recorder (approx. 500ms).

IEC-bus short command :SOUR2:SWE:BTIM NORM

#### BLANK POLARITY

Selection of the polarity for the blank signal.

- NORM With active BLANK, the output signal is HIGH.
- INV Polarity is inverted.

IEC-bus short command :OUTP:BLAN NORM

#### MARKER POLARITY

Selection of the polarity for the marker signal.

- NORM The output signal is HIGH when the sweep cycle reaches the mark.
- INV Polarity is inverted.

IEC-bus short command :SOUR:MARK:POL NORM

### 2.11.15 Switching On/Off Beeper (BEEPER)

Menu UTILITIES-BEEPER offers access to the switching on/off of the beeper.

**Note:** Preset does not alter the current state (ON or OFF).

Menu selection: UTILITIES - BEEPER

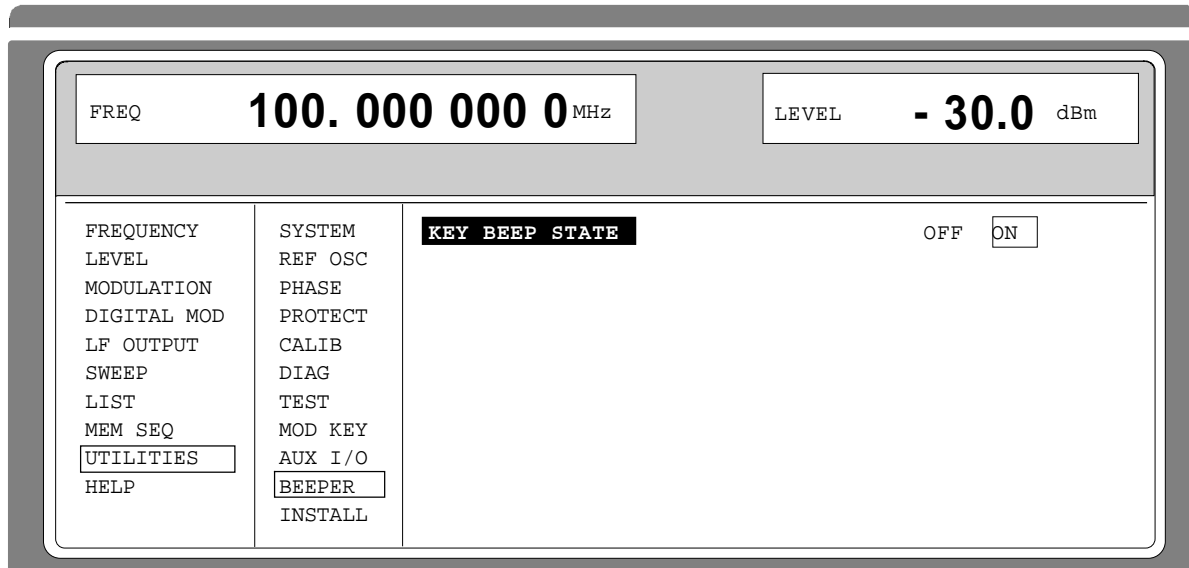

Fig. 2-78 Menu UTILITIES - BEEPER

**KEY BEEP STATE**      Switching on/off the beeper  
 IEC-bus command      :SYST:BEEP:STAT ON

### 2.11.16 Installation of Software Option

s are installed in the menu UTILITIES-INSTALL by means of a keyword. The keyword is part to the equipment supplied in case of a follow-up order.

Menu UTILITIES-INSTALL gives access to the keyword entry.

Menu selection: UTILITIES - INSTALL

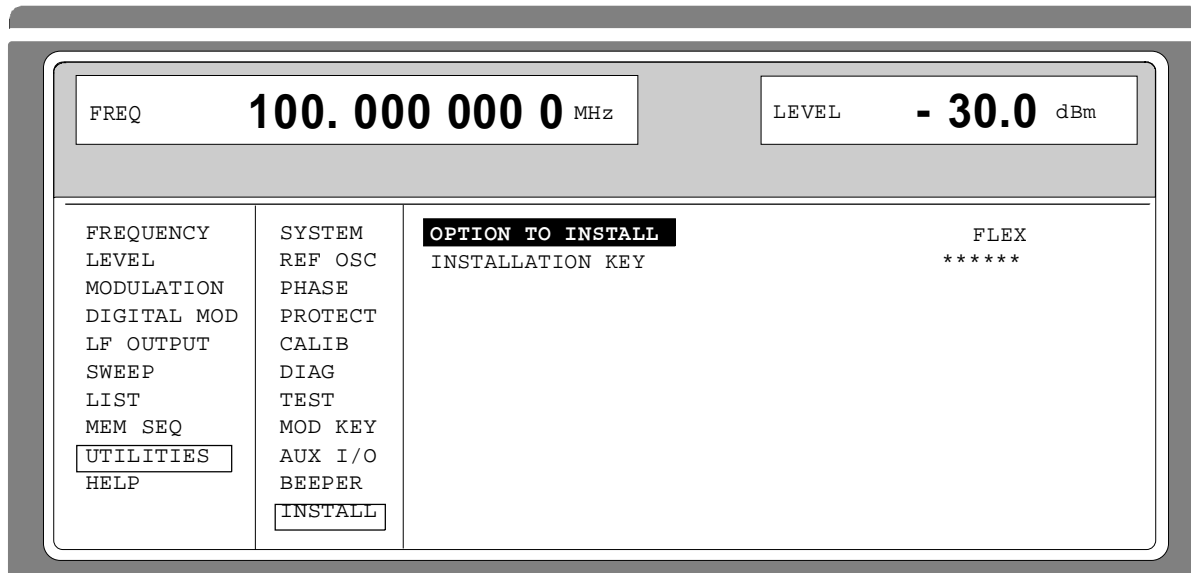

Fig. 2-79 Menu UTILITIES - INSTALL, fitted with options

**OPTION TO INSTALL**

Selection of the option to be installed.

**INSTALLATION KEY**

Entry of the keyword; after entry, press key [ENTER].

## 2.12 The Help System

The SME has two help systems. On the one hand the context-sensitive help which is called by means of the HELP key and which gives information on the current menu. On the other hand, auxiliary texts can be selected according to headwords in alphabetical order by accessing menu HELP.

### HELP Key

The yellow HELP key can be pressed at any point in time. The current setting menu is faded out and context-sensitive text faded in. The help panel can be exited by means of the RETURN key.

### Menu HELP

After calling the help menu, access to all auxiliary texts is possible via an index. Operation is analog to menu operation.

- Set the menu cursor to the index desired using the shaft encoder.
- Press the [SELECT] key.
- The information for the index marked is displayed.
- Press the [RETURN] key to exit the menu.

## 2.13 Status

By means of a STATUS page, the SME permits an overview over all settings of the instrument. The settings are displayed in an abbreviated form. The STATUS page is called by pressing the [STATUS] key. Return to the preceding menu is effected using the [RETURN] key.

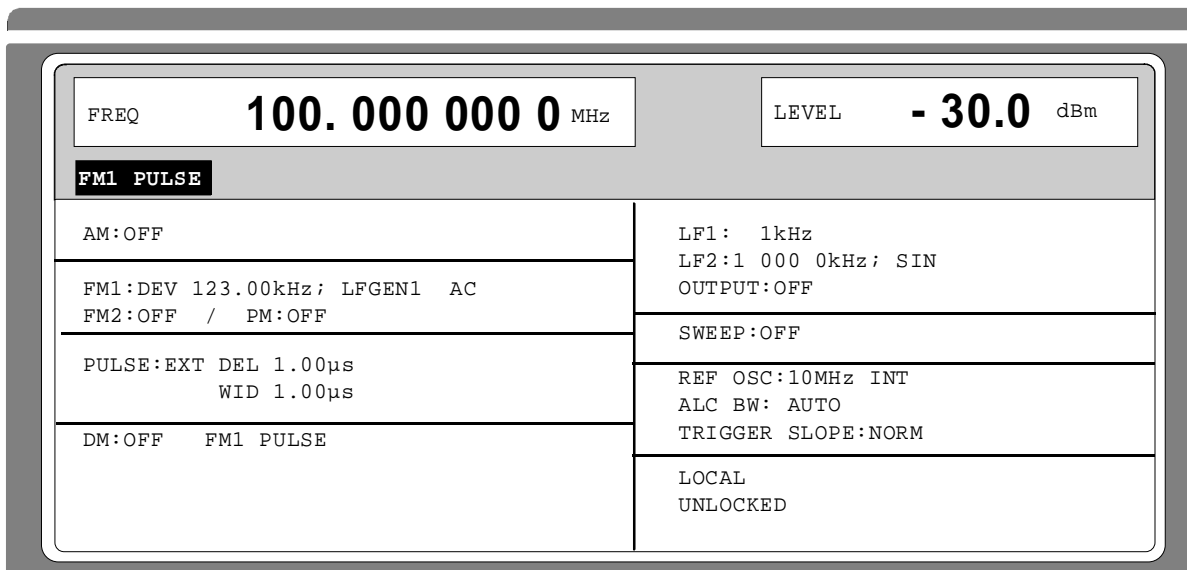

Fig. 2-80 Menu STATUS page

## 2.14 Error Messages

The SME displays error and caution messages in a different manner, depending on how long, for a short period of time or permanently, the cause exists.

### Short-term message

The short-term message is displayed in the status line. Part of it overwrites the status indications and disappears after approx. 2 seconds or in the case of a new entry.

The instrument shows, e.g., short-term messages if the attempt is made to enter an overrange or if incompatible operating modes deactivate one another.

### Long-term message

The long-term message is displayed in the status line by means of the message "WARNING" or "ERROR". Pressing the [ERROR] key calls the ERROR page in which the messages are entered. Several messages can be entered at the same time. The long-term message remains existing until there is no cause any more. The ERROR page is exited using the [RETURN] key.

The instrument displays, e.g., the long-term message "ERROR" if there is a hardware error or "WARNING" if overrange settings have been made.

**Notes:** – An error message "ERROR" does not necessarily point to a defect instrument. There are various operating states which can cause an ERROR message. E. g. if the instrument is set to external reference but no external reference is connected.

- Error 313 indicates the loss of calibration data and is also applicable in case of a cold start (key [PRESET] is pressed during switch-on). The calibration values can be restored with internal calibration routines. These routines are accessible via menu UTILITIES-CALIB (see section on calibration).

The ERROR page offers access to long-term messages if the [ERROR] key is pressed.

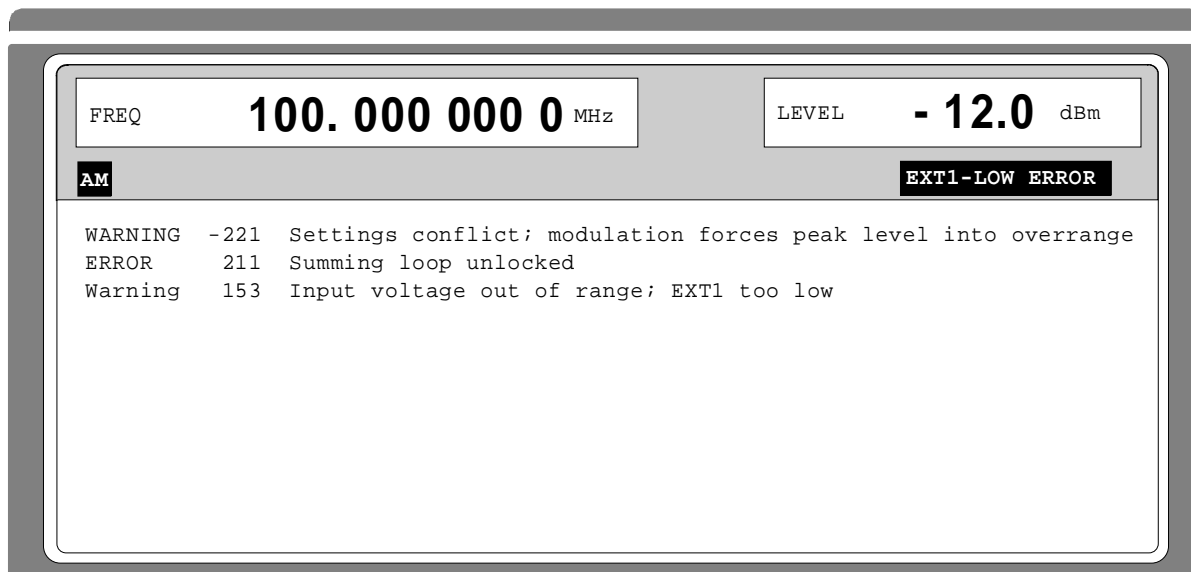

Fig. 2-81 ERROR page

A list of the possible error messages is to be found in annex B.



## 3 Remote Control

### 3.1 Introduction

The instrument is equipped with an IEC-bus interface according to standard IEC 625.1/IEEE 488.1 and a RS-232 interface. The connectors are located at the rear of the instrument and permit to connect a controller for remote control. The instrument supports the SCPI version 1994.0 (Standard Commands for Programmable Instruments). The SCPI standard is based on standard IEEE 488.2 and aims at the standardization of device-specific commands, error handling and the status registers (see Section 3.5.1).

This section assumes basic knowledge of IEC-bus programming and operation of the controller. A description of the interface commands is to be obtained from the relevant manuals.

The requirements of the SCPI standard placed on command syntax, error handling and configuration of the status registers are explained in detail in the respective sections. Tables provide a fast overview of the commands implemented in the instrument and the bit assignment in the status registers. The tables are supplemented by a comprehensive description of every command and the status registers. Detailed program examples of the main functions are to be found in annex D. The program examples for IEC-bus programming are all written in QuickBASIC.

**Note:** *In contrast to manual control, which is intended for maximum possible operating convenience, the priority of remote control is the predictability of the device status. This means that when incompatible settings (e.g. activation of PM and FM at the same time) are attempted, the command is ignored and the device status remains unchanged, i.e. is not adapted to other settings. Therefore, IEC/IEEE-bus control programs should always define an initial device status (e.g. with command \*RST) and then implement the required settings.*

### 3.2 Brief Instructions

The short and simple operating sequence given below permits fast putting into operation of the instrument and setting of its basic functions.

#### 3.2.1 IEC-Bus

It is assumed that the IEC-bus address, which is factory-set to 28 has not yet been changed.

1. Connect instrument and controller using IEC-bus cable.
2. Write and start the following program on the controller:

CALL IBFIND("DEV1", generator%)	Open port to the instrument
CALL IBPAD(generator%, 28)	Inform controller about instrument address
CALL IBWRT(generator%, "*RST;*CLS")	Reset instrument
CALL IBWRT(generator%, "FREQ 50MHz")	Set frequency to 50 MHz
CALL IBWRT(generator%, "POW -7.3dBm")	Set output level -7.3m dBm
CALL IBWRT(generator%, "AM:SOUR INT1")	Set AM modulation source LFGEN1
CALL IBWRT(generator%, "AM:INT1:FREQ 15kHz")	Set AM modulation source LFGEN1
CALL IBWRT(generator%, "AM 30PCT")	Set AM modulation depth 30%
CALL IBWRT(generator%, "AM:STAT ON")	Switch on AM

An amplitude-modulated signal is now applied at the output of the instrument.

3. To return to manual control, press the LOCAL key at the front panel.

### 3.2.2 RS-232 Interface

It is assumed that the configuration of the RS-232 interface at the unit has not yet been changed.

1. Connect unit and controller using the 0-modem cable.
2. Enter the following command at the controller to configure the controller interface:

```
mode com1: 9600, n, 8, 1
```

3. Create the following ASCII file:

*RST; *CLS	Switch instrument to remote control (Return key)
FREQ 50MHz	Reset instrument
POW -7.3dBm	Set frequency 50 MHz
OUTP:STAT ON	Set output level -7.3 dBm
AM:SOUR INT1	Switch on RF output
AM:INT1:FREQ 15kHz	Set AM modulation source LFGEN1
AM 30PCT	Set modulation frequency 15 kHz
AM:STAT ON	Set AM modulation depth 30%
	Switch on AM
	(Return key)

4. Transfer ASCII file to unit via RS-232 interface. Enter the following command at the controller:

```
copy <filename> com1:
```

An amplitude-modulated signal is now applied at the output of the instrument.

5. To return to manual control, press the [LOCAL] key at the front panel.

### 3.3 Switchover to Remote Control

On power-on, the instrument is always in the manual operating state ("LOCAL"state) and can be operated via the front panel.

The instrument is switched to remote control ("REMOTE") state)

IEC-bus as soon as it receives an addressed command from a controller.

RS-232 as soon as it receives either a carriage return <CR> (=0Dh) or a line feed <LF> (0Ah) from a controller.

During remote control, operation via the front panel is disabled. The instrument remains in the remote state until it is reset to the manual state via the front panel or via IEC bus (see Sections 3.3.1.3 and 3.3.2.3). Switching from manual operation to remote control and vice versa does not affect the remaining instrument settings.

### 3.3.1 Remote Control via IEC Bus

#### 3.3.1.1 Setting the Device Address

The IEC-bus address of the instrument is factory-set to 28. It can be changed manually in the UTILITIES-SYSTEM-GPIB-ADDRESS menu or via IEC bus. Addresses 0 to 30 are permissible.

**Manually:**

- Call UTILITIES-SYSTEM-GPIB-ADDRESS menu
- Enter desired address
- Terminate input using the [1x/ENTER] key

**Via IEC bus:**

<pre>CALL IBFIND("DEV1", generator%) CALL IBPAD(generator%, 28)</pre>	<p>Open port to the instrument Inform controller about old address</p>
<pre>CALL IBWRT(generator%, "SYST:COMM:GPIB:ADDR 20") CALL IBPAD(generator%, 20)</pre>	<p>Set instrument to new address Inform controller about new address</p>

#### 3.3.1.2 Indications during Remote Control

The state of the remote control is evident by the words "IEC REMOTE" or "LOCAL" on the STATUS page. The STATUS page is always displayed in the REMOTE state.

LOCKED indicates that the key [LOCAL] is disabled, i.e. switchover to manual operation is only possible via IEC/IEEE bus. With UNLOCKED indicated, switchover to manual control is possible via the key [LOCAL] (see also section 3.3.1.3).

#### 3.3.1.3 Querying the Error Status

```
CALL IBWRT(generator%, "SYST:SERR?")
CALL IBRD(generator%, error$)
```

The string `error$` contains the list of errors existing at the time of the query. This list corresponds to the list displayed when the [ERROR] key is pressed in manual operation (see Section 2.14). It differs from the SCPI error list in that error entries are not deleted by the query. They are deleted only when the corresponding errors don't exist any more (e.g. after a setting has been changed).

#### 3.3.1.4 Return to Manual Operation

Return to manual operation is possible via the front panel or the IEC bus.

**Manually:** ➤ Press the [LOCAL] key.

**Notes:**

- Before switchover, command processing must be completed as otherwise switchover to remote control is effected immediately.
- The [LOCAL] key can be disabled by the universal command LLO (see annex A) in order to prevent unintentional switchover. In this case, switchover to manual mode is only possible via the IEC bus.
- The [LOCAL] key can be enabled again by deactivating the REN control line of the IEC bus (see annex A).

**Via IEC bus:**

```
...
CALL IBLOC(generator%)           Set instrument to manual operation.
...
```

### 3.3.2 Remote Control via RS-232-Interface

#### 3.3.2.1 Setting the Transmission Parameters

To enable an error-free and correct data transmission, the parameters of the unit and the controller should have the same setting. To prevent any problems during binary data transmission, the RS-232 interface is set for 8 data bits, no parity and 1 stop bit. This data format corresponds to the current IEEE P1174 standard. Parameters baud rate and handshake can be manually changed in menu UTILITIES-SYSTEM-RS-232.

- Call UTILITIES-SYSTEM-GPIB-RS232 menu
- Select desired baudrate and handshake
- Terminate input using the [1x/ENTER] key

#### 3.3.2.2 Indications during Remote Control

The state of the remote control is evident by the words "RS-232 REMOTE" or "LOCAL" on the STATUS page. The STATUS page is always displayed in the REMOTE state.

#### 3.3.2.3 Return to Manual Operating

Return to manual operation is possible via the front panel.

- Press the [LOCAL] key.

**Note:** Before switchover, command processing must be completed as otherwise switchover to remote control is effected immediately.

## 3.4 Messages

The messages transferred via the data lines of the IEC bus (see annex A) can be divided into two groups:

- **interface messages** and
- **device messages.**

### 3.4.1 Interface Message

Interface messages are transferred on the data lines of the IEC bus, the ATN control line being active. They are used for communication between controller and instrument and can only be sent by a controller which has the IEC-bus control. Interface commands can be subdivided into

- **universal commands** and
- **addressed commands.**

Universal commands act on all devices connected to the IEC bus without previous addressing, addressed commands only act on devices previously addressed as listeners. The interface messages relevant to the instrument are listed in annex A.

Some control characters are defined for the control of the RS-232-interface (see annex A)

### 3.4.2 Device Messages (Commands and Device Responses)

Device messages are transferred on the data lines of the IEC bus, the "ATN" control line not being active. ASCII code is used. The device messages are largely identical for the two interfaces (IEC bus and RS232) .

A distinction is made according to the direction in which they are sent on the IEC bus:

- **Commands** are messages the controller sends to the instrument. They operate the device functions and request information.  
The commands are subdivided according to two criteria:
  1. According to the effect they have on the instrument:
    - Setting commands** cause instrument settings such as reset of the instrument or setting the output level to 1 volt.
    - Queries** cause data to be provided for output on the IEC-bus, e.g. for identification of the device or polling the active input.
  2. According to their definition in standard IEEE 488.2:
    - Common Commands** are exactly defined as to their function and notation in standard IEEE 488.2. They refer to functions such as management of the standardized status registers, reset and selftest.
    - Device-specific commands** refer to functions depending on the features of the instrument such as frequency setting. A majority of these commands has also been standardized by the SCPI committee (cf. Section 3.5.1).
- **Device responses** are messages the instrument sends to the controller after a query. They can contain measurement results, instrument settings and information on the instrument status (cf. Section 3.5.4).

Structure and syntax of the device messages are described in Section 3.5. The commands are listed and explained in detail in Section 3.6.

## 3.5 Structure and Syntax of the Device Messages

### 3.5.1 SCPI Introduction

SCPI (Standard Commands for Programmable Instruments) describes a standard command set for programming instruments, irrespective of the type of instrument or manufacturer. The goal of the SCPI consortium is to standardize the device-specific commands to a large extent. For this purpose, a model was developed which defines the same functions inside a device or for different devices. Command systems were generated which are assigned to these functions. Thus it is possible to address the same functions with identical commands. The command systems are of a hierarchical structure. Fig. 3-1 illustrates this tree structure using a section of command system SOURce, which operates the signal sources of the devices. The other examples concerning syntax and structure of the commands are derived from this command system.

SCPI is based on standard IEEE 488.2, i.e. it uses the same syntactic basic elements as well as the common commands defined in this standard. Part of the syntax of the device responses is defined with greater restrictions than in standard IEEE 488.2 (see Section 3.5.4, Responses to Queries).

### 3.5.2 Structure of a Command

The commands consist of a so-called header and, in most cases, one or more parameters. Header and parameter are separated by a "white space" (ASCII code 0 to 9, 11 to 32 decimal, e.g. blank). The headers may consist of several key words. Queries are formed by directly appending a question mark to the header.

**Note:** *The commands used in the following examples are not in every case implemented in the instrument.*

#### Common Commands

Common commands consist of a header preceded by an asterisk "\*" and one or several parameters, if any.

Examples: \*RST RESET, resets the device  
 \*ESE 253 EVENT STATUS ENABLE, sets the bits of the event status enable registers  
 \*ESR? EVENT STATUS QUERY, queries the contents of the event status register.

#### Device-specific commands

Hierarchy:

Device-specific commands are of hierarchical structure (see Fig. 3-1). The different levels are represented by combined headers. Headers of the highest level (root level) have only one key word. This key word denotes a complete command system.

Example: SOURce This key word denotes the command system SOURce.

For commands of lower levels, the complete path has to be specified, starting on the left with the highest level, the individual key words being separated by a colon ":".

Example: SOURce:FM:EXTernal:COUpling AC

This command lies in the fourth level of the SOURce system. It sets the coupling of the external signal source to AC.

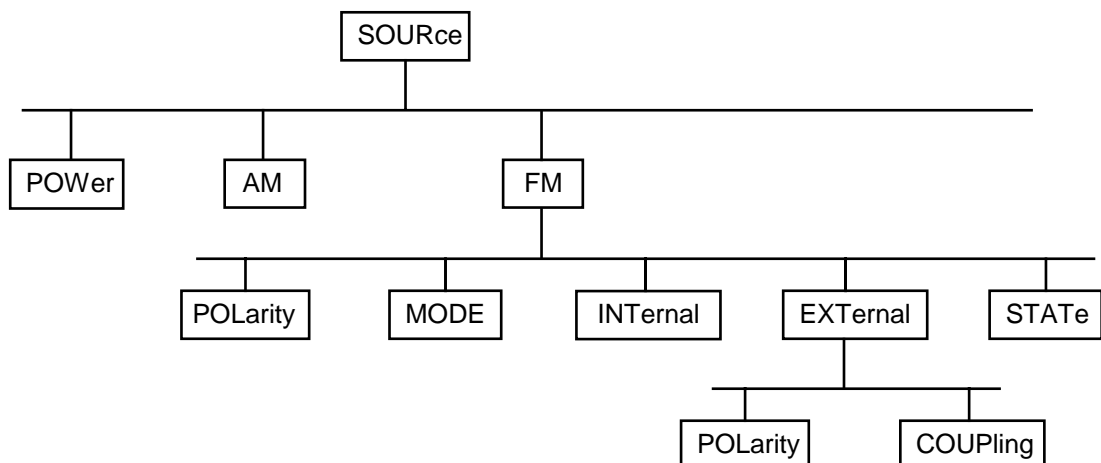

Fig. 3-1 Tree structure of the SCPI command systems using the SOURce system by way of example

Some key words occur in several levels within one command system. Their effect depends on the structure of the command, that is to say, at which position in the header of a command they are inserted.

Example: `SOURce:FM:POLarity NORMal`

This command contains key word POLarity in the third command level. It defines the polarity between modulator and modulation signal.

`SOURce:FM:EXTernal:POLarity NORMal`

This command contains key word POLarity in the fourth command level. It defines the polarity between modulation voltage and the resulting direction of the modulation only for the external signal source indicated.

Optional key words: Some command systems permit certain key words to be optionally inserted into the header or omitted. These key words are marked by square brackets in the description. The full command length must be recognized by the instrument for reasons of compatibility with the SCPI standard. Some commands are considerably shortened by these optional key words.

Example: `[SOURce]:POWer[:LEVel][:IMMediate]:OFFSet 1`

This command immediately sets the offset of the signal to 1 volt. The following command has the same effect:

`POWer:OFFSet 1`

**Note:** *An optional key word must not be omitted if its effect is specified in detail by a numeric suffix.*

Long and short form: The key words feature a long form and a short form. Either the short form or the long form can be entered, other abbreviations are not permissible.

Example: `STATus:QUESTionable:ENABle 1= STAT:QUES:ENAB 1`

**Note:** *The short form is marked by upper-case letters, the long form corresponds to the complete word. Upper-case and lower-case notation only serve the above purpose, the instrument itself does not make any difference between upper-case and lower-case letters.*

Parameter: The parameter must be separated from the header by a "white space". If several parameters are specified in a command, they are separated by a comma ",". A few queries permit the parameters MINimum, MAXimum and DEFault to be entered. For a description of the types of parameter, refer to Section 3.5.5.

Example: `SOURce:POWer:ATTenuation? MAXimum Response:60`

This query requests the maximal value for the attenuation.

Numeric suffix: If a device features several functions or features of the same kind, e.g. inputs, the desired function can be selected by a suffix added to the command. Entries without suffix are interpreted like entries with the suffix 1.

Example: `SOURce:FM:EXTernal2:COUpling AC`

This command sets the coupling of the second external signal source.

### 3.5.3 Structure of a Command Line

A command line may consist of one or several commands. It is terminated by a <New Line>, a <New Line> with EOI or an EOI together with the last data byte. Quick BASIC automatically produces an EOI together with the last data byte.

Several commands in a command line are separated by a semicolon ";". If the next command belongs to a different command system, the semicolon is followed by a colon.

Example:

```
CALL IBWRT(generator%, "SOURCE:POWER:CENTer MINimum;:OUTPut:ATTenuation 10")
```

This command line contains two commands. The first command is part of the SOURCE system and is used to specify the center frequency of the output signal. The second command is part of the OUTPUT system and sets the attenuation of the output signal.

If the successive commands belong to the same system, having one or several levels in common, the command line can be abbreviated. To this end, the second command after the semicolon starts with the level that lies below the common levels (see also Fig. 3-1). The colon following the semicolon must be omitted in this case.

Example:

```
CALL IBWRT(generator%, "SOURCE:FM:MODE LOCKed;:SOURCE:FM:INTernal:FREQuency 1kHz")
```

This command line is represented in its full length and contains two commands separated from each other by the semicolon. Both commands are part of the SOURCE command system, subsystem FM, i.e. they have two common levels.

When abbreviating the command line, the second command begins with the level below SOURCE:FM. The colon after the semicolon is omitted.

The abbreviated form of the command line reads as follows:

```
CALL IBWRT(generator%, "SOURCE:FM:MODE LOCKed;INTernal:FREQuency 1kHz")
```

However, a new command line always begins with the complete path.

```
Example: CALL IBWRT(generator%, "SOURCE:FM:MODE LOCKed")
CALL IBWRT(generator%, "SOURCE:FM:INTernal:FREQuency 1kHz")
```

### 3.5.4 Responses to Queries

A query is defined for each setting command unless explicitly specified otherwise. It is formed by adding a question mark to the associated setting command. According to SCPI, the responses to queries are partly subject to stricter rules than in standard IEEE 488.2.

1. The requested parameter is transmitted without header.

Example: SOURCE:EXTernal:COUPling? Response: AC

2. Maximum values, minimum values and all further quantities, which are requested via a special text parameter are returned as numerical values.

Example: FREQuency? MAX Response: 10E3

3. Numerical values are output without a unit. Physical quantities are referred to the basic units or to the units set using the Unit command.

Example: FREQuency? Response: 1E6 for 1 MHz

4. Truth values <Boolean values> are returned as 0 (for OFF) and 1 (for ON).

Example: OUTPut:STATe? Response: 1

5. Text (character data) is returned in a short form (see also Section 3.5.5).

Example: SOURCE:FM:SOURCE? Response: INT1



### 3.5.5 Parameter

Most commands require a parameter to be specified. The parameters must be separated from the header by a "white space". Permissible parameters are numerical values, Boolean parameters, text, character strings and block data. The type of parameter required for the respective command and the permissible range of values are specified in the command description (see Section 3.6).

**Numerical values** Numerical values can be entered in any form, i.e. with sign, decimal point and exponent. Values exceeding the resolution of the instrument are rounded up or down. The mantissa may comprise up to 255 characters, the exponent must lie inside the value range -32000 to 32000. The exponent is introduced by an "E" or "e". Entry of the exponent alone is not permissible. In the case of physical quantities, the unit can be entered. Permissible unit prefixes are G (giga), MA (mega), MOHM and MHZ are also permissible), K (kilo), M (milli), U (micro) and N (nano). If the unit is missing, the basic unit is used.

Example: `SOURce:FREQuency 1.5 kHz = SOURce:FREQuency 1.5E3`

**Special numerical values** The texts MINimum, MAXimum, DEFault, UP and DOWN are interpreted as special numerical values.

In the case of a query, the numerical value is provided.

Example: Setting command: `SOURce:VOLTage MAXimum`  
 Query: `SOURce:VOLTage?` Response: 15

MIN/MAX MINimum and MAXimum denote the minimum and maximum value.

DEF DEFault denotes a preset value which has been stored in the EPROM. This value conforms to the default setting, as it is called by the \*RST command.

UP/DOWN UP, DOWN increases or reduces the numerical value by one step. The step width can be specified via an allocated step command (see annex C, List of Commands) for each parameter which can be set via UP, DOWN.

INF/NINF INFINITY, Negative INFINITY (NINF) represent the numerical values -9.9E37 or 9.9E37, respectively. INF and NINF are only sent as device responses.

NAN Not a Number (NAN) represents the value 9.91E37. NAN is only sent as device response. This value is not defined. Possible causes are the division of zero by zero, the subtraction of infinite from infinite and the representation of missing values.

**Boolean Parameters** Boolean parameters represent two states. The ON state (logically true) is represented by ON or a numerical value unequal to 0. The OFF state (logically untrue) is represented by OFF or the numerical value 0. 0 or 1 is provided in a query.

Example: Setting command: `SOURce:FM:STATe ON`  
 Query: `SOURce:FM:STATe?` Response: 1

**Text** Text parameters observe the syntactic rules for key words, i.e. they can be entered using a short or long form. Like any parameter, they have to be separated from the header by a white space. In the case of a query, the short form of the text is provided.

Example: Setting command: `OUTPut:FILTer:TYPE EXTernal`  
 Query: `OUTPut:FILTer:TYPE?` Response: EXT

**Strings** Strings must always be entered in quotation marks (' or ").

Example: `SYSTem:LANGuage "SCPI"` or  
`SYSTem:LANGuage 'SCPI'`

**Block data**

Block data are a transmission format which is suitable for the transmission of large amounts of data. A command using a block data parameter has the following structure:

Example: HEADer:HEADer #45168xxxxxxxx

ASCII character # introduces the data block. The next number indicates how many of the following digits describe the length of the data block. In the example the 4 following digits indicate the length to be 5168 bytes. The data bytes follow. During the transmission of these data bytes all End or other control signs are ignored until all bytes are transmitted. Data elements comprising more than one byte are transmitted with the byte being the first which was specified by SCPI command "FORMat:BOARDer".

The format of the binary files within the block depends on the IEC-bus command

The commands

```
:SOURce:LIST:DWELI
:SOURce:LIST:FREQuency
:SOURce:LIST:POWer
:SOURce:CORRection:CSET:DATA:FREQuency
:SOURce:CORRection:CSET:DATA:POWer
:SYSTem:MSEQuence:DWELI
:SYSTem:MSEQuence:RCL
```

use the IEEE-754 format for double precision floating point numbers. Each number is represented by 8 bytes.

**Example:**

a# = 125.345678E6

b# = 127.876543E6

```
CALL IBWRT(generator%, "SOURCE:CORRECTION:CSET:DATA:FREQ
#216" + MKD$(a#) + MKD$(b#))
```

- '#' in the command string introduces the binary block,
- '2' indicates that 2 digits specifying the length will follow next,
- '16' is the length of the binary block (in bytes), here: 2 double precision floating point number with 8 bytes each.
- The actual binary data follow now. As the function IBWRT requires a text string, MKD\$ is used for the type conversion.

The following ASCII format has the same effect:

```
CALL IBWRT(generator%, "SOURCE:CORRECTION:CSET:DATA:FREQ
125.345678E6, 127.876543E6")
```

The commands

```
:SOURce:DM:DATA:DATA
:SOURce:DM:DATA:ATTenuate
:SOURce:DM:DATA:BURSt
```

use a bit-by-bit format. The data transmitted are evaluated byte by byte from the left to the right and from the MSBit to the LSBit.

**Example:**

The following sequence of modulation data is to be transmitted as a binary block:

01010101 00110011 00001111 11111111 00000000 (binary representation)

55 33 0F FF 00 (hexadecimal rep.)

The QuickBASIC-command reads:

```
CALL IBWRT(generator%, "SOURCE:DM:DATA:DATA #15"+CHR$(
&h55)+CHR$( &h33)+CHR$( &h0F) +CHR$( &hFF)+CHR$( &h00))
```

- '#' introduces the binary block.
- '1' indicates that 1 digit specifying the length will follow next,
- '5' is the length of the binary block (in bytes).
- 'The actual binary data follow now. As the function IBWRT requires a text string, CHR\$ is used for the type conversion.

The following ASCII format has the same effect:

```
CALL IBWRT(generator%, "SOURCE:DM:DATA:DATA 0,1,0,1,0,
1,0,1,0,0,1,1,0,0,1,1,0,0,0,0,1,1,1,1,
1,1,1,1,1,1,1,1,0,0,0,0,0,0,0,0")
```

However, the binary representation is more compact and transmitted faster.

The number of data bits must be an integer multiple of 8 because, according to IEEE 488.2, binary blocks allow transmission of integer bytes only. Eventually, the binary block must be filled up to the next byte; the spare bits can then be deleted manually.

### 3.5.6 Overview of Syntax Elements

The following survey offers an overview of the syntax elements.

- : The colon separates the key words of a command.  
In a command line the separating semicolon marks the uppermost command level.
- ; The semicolon separates two commands of a command line.  
It does not alter the path.
- , The comma separates several parameters of a command.
- ? The question mark forms a query.
- \* The asterix marks a common command.
- " Quotation marks introduce a string and terminate it.
- # ASCII character # introduces block data.
- A "white space" (ASCII-Code 0 to 9, 11 to 32 decimal, e.g. blank) separates header and parameter.

## 3.6 Description of Commands

### 3.6.1 Notation

In the following sections, all commands implemented in the instrument are first listed in tables and then described in detail, separated according to the command system. The notation corresponds to the one of the SCPI standards to a large extent. The SCPI conformity information can be taken from the list of commands in annex C.

#### Table of Commands

Command:	In the command column, the table provides an overview of the commands and their hierarchical arrangement (see indentations).
Parameter:	In the parameter column the requested parameters are indicated together with their specified range.
Unit:	The unit column indicates the basic unit of the physical parameters.
Remark:	In the remark column an indication is made on <ul style="list-style-type: none"> <li>- whether the command does not have a query form,</li> <li>- whether the command has only one query form ,</li> <li>- whether this command is implemented only with a certain option of the instrument.</li> </ul>

#### Indentations

The different levels of the SCPI command hierarchy are represented in the table by means of indentations to the right. The lower the level is, the farther the indentation to the right is. Please observe that the complete notation of the command always includes the higher levels as well.

Example: `SOURce:FM:MODE` is represented in the table as follows:

<code>SOURce</code>	first level
<code>:FM</code>	second level
<code>:MODE</code>	third level

In the individual description, the complete notation of the command is given. An example for each command is written out at the end of the individual description.

#### Upper/lower case notation

Upper/lower case letters serve to mark the long or short form of the key words of a command in the description (see Section 3.5.2). The instrument itself does not distinguish between upper and lower case letters.

**Special characters |** A selection of key words with an identical effect exists for several commands. These key words are indicated in the same line, they are separated by a vertical stroke. Only one of these key words has to be indicated in the header of the command. The effect of the command is independent of which of the key words is indicated.

Example: `SOURce`  
           `:FREQuency`  
           `:CW | :FIXed`

The two following commands of identical meaning can be formed. They set the frequency of the constantly frequent signal to 1 kHz:

`SOURce:FREQuency:CW 1E3 = SOURce:FREQuency:FIXed 1E3`

A vertical stroke in indicating the parameters marks alternative possibilities in the sense of "or". The effect of the command is different, depending on which parameter is entered.

Example: Selection of the parameters for the command

`SOURce:COUPling AC | DC`

If parameter AC is selected, only the AC content is fed through, in the case of DC, the DC as well as the AC content.

- [ ] Key words in square brackets can be omitted when composing the header (cf. Section 3.5.2, Optional Keywords). The full command length must be accepted by the instrument for reasons of compatibility with the SCPI standards.  
Parameters in square brackets can optionally be incorporated in the command or omitted as well.
- { } Parameters in braces can optionally be incorporated in the command either not at all, once or several times.

### 3.6.2 Common Commands

The common commands are taken from the IEEE 488.2 (IEC 625-2) standard. Some commands have the same effect on different devices. The headers of these commands consist of an asterisk "\*" followed by three letters. Many common commands refer to the status reporting system which is described in detail in Section 3.8.

Table 3-1 Common Commands

Command	Parameter	Unit	Remark
*CLS			No query
*ESE	0 to 255		
*ESR?			Only query
*IDN?			Only query
*IST?			Only query
*OPC			
*OPT?			Only query
*PRE	0 to 255		
*PSC	0   1		
*RCL	0 to 50		No query
*RST			No query
*SAV	1 to 50		No query
*SRE	0 to 255		
*STB?			Only query
*TRG			No query
*TST?			Only query
*WAI			

#### \*CLS

**CLEAR STATUS** sets the status byte (STB), the standard event register (ESR) and the EVENT-part of the QUESTIONable and the OPERATION register to zero. The command does not alter the mask and transition parts of the registers. It clears the output buffer

#### \*ESE 0 to 255

**EVENT STATUS ENABLE** sets the event status enable register to the value indicated. Query \*ESE? returns the contents of the event status enable register in decimal form.

**\*ESR?**

**STANDARD EVENT STATUS QUERY** returns the contents of the event status register in decimal form (0 to 255) and subsequently sets the register to zero.

**\*IDN?**

**IDENTIFICATION QUERY** queries the instrument identification.

The device response is for example: "Rohde&Schwarz, SME03,00000001, 1.03"

03 = variant identification

00000001 = serial number

1.03 = firmware version number

**\*IST?**

**INDIVIDUAL STATUS QUERY** returns the contents of the IST flag in decimal form (0 | 1). The IST flag is the status bit which is sent during a parallel poll (cf. Section 3.8.3.2).

**\*OPC**

**OPERATION COMPLETE** sets bit 0 in the event status register when all preceding commands have been executed. This bit can be used to initiate a service request (cf. Section 3.7).

**\*OPT?**

**OPTION IDENTIFICATION QUERY** queries the options included in the instrument and returns a list of the options installed. The options are separated from each other by means of commas. For every option, a fixed position is provided in the response.

Table 3-2 Device Response to \*OPT?

Position	Option	
1	SM-B1	Reference oscillator OCXO
2	SM-B2	LF generator
3	SM-B2	2nd LF generator
4	SM-B3	Pulse modulator 1.5 GHz
5	SM-B4	Pulse generator
6	SM-B5	FM/PM modulator
7	SM-B6	Multifunction generator
8	SM-B8	Pulse modulator 3 GHz
9	SM-B9	Pulse modulator 6 GHz
10	SME-B11	DM coder
11	SME-B12	DM memory extension

Example for a device response: 0,SM-B2,0, 0,0,SM-B5,0,0,0,0,0

**\*PRE** 0 to 255

**PARALLEL POLL REGISTER ENABLE** sets the parallel poll enable register to the value indicated. Query \*PRE? returns the contents of the parallel poll enable register in decimal form.

**\*PSC** 0 | 1

**POWER ON STATUS CLEAR** determines whether the contents of the ENABLE registers is maintained or reset in switching on.

\*PSC = 0 causes the contents of the status registers to be maintained. Thus a service request can be triggered in switching on in the case of a corresponding configuration of status registers ESE and SRE.

\*PSC ≠ 0 resets the registers.

Query \*PSC? reads out the contents of the power-on-status-clear flag. The response can be 0 or 1.

**\*RCL** 0 to 50

**RECALL** calls the instrument state which was stored under the number supplied using command \*SAV. 50 instrument states can be stored.

**\*RST**

**RESET** sets the instrument to a defined default status. The command essentially corresponds to pressing the [PRESET] key. The state of the RF-output is an exception: The RF-output is deactivated after \*RST, however, it is activated after the [RESET] key has been pressed. The default setting is indicated in the description of the commands.

**\*SAV** 1 to 50

**SAVE** stores the current instrument state under the number indicated (cf. \*RCL as well).

**\*SRE** 0 to 255

**SERVICE REQUEST ENABLE** sets the service request enable register to the value indicated. Bit 6 (MSS mask bit) remains 0. This command determines under which conditions a service request is triggered. Query \*SRE? reads the contents of the service request enable register in decimal form. Bit 6 is always 0.

**\*STB?**

**READ STATUS BYTE QUERY** reads out the contents of the status byte in decimal form.

**\*TRG**

**TRIGGER** triggers all actions waiting for a trigger event. Special trigger events can be started by command system "TRIGger" (see section "TRIGger System").

**\*TST?**

**SELF TEST QUERY** triggers all selftests of the instrument indicated in Chapter 4, Section "Functional Test" and outputs an error code in decimal form.

**\*WAI**

**WAIT-to-CONTINUE** only permits the servicing of the subsequent commands after all preceding commands have been executed and all signals have settled (cf. Section 3.7 and "\*OPC" as well).



### 3.6.3 ABORt System

The ABORt system contains the commands to abort actions triggered. After an action has been aborted, it can be triggered again at once. All commands trigger an event, thus they have no \*RST value.

Further commands for the trigger system of the SME can be found in the TRIGger system.

Command	Parameter	Default Unit	Remark
:ABORt			
[:SWEep]			No query
:LIST			No query
:MSEquence			No query
:DM			No query / option SME-B11
:XMEM			No query / option SME-B12

#### :ABORt[:SWEep]

The command aborts a sweep.

Example: :ABOR:SWE

#### :ABORt:LIST

The command aborts a list execution.

Example: :ABOR:LIST

#### :ABORt:MSEquence

The command aborts a Memory Sequence.

Example: :ABOR:MSEQ

#### :ABORt:DM

The command aborts the single execution of a DM list. The command always relates to the digital type of modulation currently set using `SOURCE:DM:TYPE`.

Example: :ABOR:DM

#### :ABORt:XMEM

The command aborts the recording of data into the DM memory extension, list "XMEM".

Example: :ABOR:XMEM

### 3.6.4 CALibration-System

The CALibration system contains the commands to calibrate the SME. On triggering the calibration by means of `:MEASure`, response "0" displays a faultless calibration, response "1" means that an error has occurred during calibration. As to the meaning of the data in the case of query `:DATA?`, cf. Chapter 2, Section "Calibration".

Command	Parameter	Default Unit	Remark
<b>:CALibration</b>			
<b>:QPSK</b>			Option SME-B11
[:DATA]	0 to 10 000 ns   DEFault	s	
:STORe			
<b>:LEVel</b>			
:DATA?			Query only
:FRANge	NORMal   MIXer		
:PMODulator	ON   OFF		
:STATe	ON   OFF		
<b>:LPReset</b>			
[:MEASure]?			Query only
:DATA?			Query only
<b>:PULSe</b>			Option SM-B4
[:MEASure]?			Query only
:DATA?			Query only
<b>:ROSCillator</b>			
[:DATA]	0 to 4095		
<b>:VSUMmation</b>			
[:MEASure]?			Query only
:OFFS?			Query only
:DAC?			Query only
:KOS?			Query only

#### :CALibration:QPSK

The commands to set the calibration value for the QPSK modulator are under this node.

#### :CALibration:QPSK[:DATA] 0 to 10 000 ns | DEFault

The command enters the calibration data. The number specifies a delay for the digital FM signal. DEFault can also be indicated instead of a time. Then the value saved in the FLASH memory is used.

Example: `:CAL:QPSK:DATA 10 000ns`

#### :CALibration:QPSK:STORe

The command saves the delay presently set under `[:DATA]` as a default value in the FLASH memory.

Example: `:CAL:QPSK:STOR`

**:CALibration:LEVel**

This node provides the commands for the management of the level correction table. The corresponding data are permanently stored in the instrument and cannot be changed. The instrument includes different level correction tables. The tables to be used are selected depending on the set frequency and the pulse modulator switched on (internal or external). The :FRANge and :PMODulator commands select the level correction tables to be read out using the DATA? command. These commands simulate the current instrument status but do not have any influence on the instrument setup. The :STATe ON command activates the level correction table corresponding to the real instrument setup.

**:CALibration:LEVel:DATA?**

The command queries the level correction data. It returns all level correction data in the format fixed in the :FORMat system. The other commands under this node determine the list that is returned.

Example: :CAL:LEV:DATA?

**:CALibration:LEVel:FRANge** NORMal | MIXer

The command selects the level correction table valid for a frequency in the NORMal or in the MIXer range.

Example: :CAL:LEV:FRAN NORM \*RST value is NORMal

**:CALibration:LEVel:PMODulator** ON | OFF

The command selects the level correction table valid for an instrument setup with the pulse modulator ON or OFF.

Example: :CAL:LEV:PMOD OFF \*RST value is OFF

**:CALibration:LEVel:STATe** ON | OFF

The command switches on or off internal level correction. \*RST value is ON.

Example: :CAL:LEV:STAT OFF

**:CALibration:LPReset**

The commands to measure the values for the level presetting table are under this node (Level PReset).

**:CALibration:LPReset[:MEASure]?**

The command triggers a calibration measurement. The command triggers an event and thus has no \*RST value.

Example: :CAL:LPR:MEAS? Response: 0

**:CALibration:LPReset:DATA?**

The command queries the correction data. It returns all correction data in the format fixed in the :FORMat system.

Example: :CAL:LPR:DATA?

**:CALibration:PULSe**

The commands to calibrate the pulse generator are under this node (option SM-B4).

**:CALibration:PULSe[:MEASure]?**

The command triggers a calibration measurement. The command triggers an event and thus has no \*RST value.

Example: :CAL:PULS:MEAS?

Response: 0

**:CALibration:PULSe:DATA?**

The command queries the correction data. It returns the correction data as two integers separated by a comma. The first number indicates the fine adjustment, the second the coarse adjustment.

Example: :CAL:PULS:DATA?

Response: 26,2

**:CALibration:ROSCillator**

The commands to calibrate the reference oscillator are under this node.

**:CALibration:ROSCillator[:DATA] 0 to 4095**

The command enters the correction data. For an exact definition of the calibration value, cf. Section 2.

Example: :CAL:ROSC:DATA 2048

**:CALibration:VSUMmation**

The commands to determine the support values for the frequency setting are under this node.

**:CALibration:VSUMmation[:MEASure]?**

The command triggers a calibration measurement. The command triggers an event and thus has no default setting value.

Example: :CAL:VSUM:MEAS?

Response: 0

**:CALibration:VSUMmation:OFFS?****:CALibration:VSUMmation:DAC?****:CALibration:VSUMmation:KOS?**

The commands query the calibration data (refer to service manual 1039.1856.24). They output all calibration data in the format set in FORMat system.

Example: :CAL:VSUM:OFFS?

### 3.6.5 DIAGnostic-System

The DIAGnostic system contains the commands for diagnostic test and service of the instrument. SCPI does not define DIAGnostic commands, the commands listed here are SME-specific. All DIAGnostic commands are queries which are not influenced by \*RST. Hence no default setting values are stated.

Command	Parameter	Default Unit	Remark
<b>:DIAGnostic</b> <b>:INFO</b> <b>:CCOunt</b> <b>:ATTenuator1 2 3 4 5 6?</b> <b>:POWEr?</b> <b>:MODules?</b> <b>:OTIME?</b> <b>:SDATE?</b> <b>[:MEASure]</b> <b>:POINT?</b> <b>:XMEM</b> <b>:CHECKsum</b> <b>:CALCulate</b> <b>[:TOTal]?</b> <b>:DATA?</b> <b>:ATTenuate?</b> <b>:BURSt?</b>			   Query only Query only Query only Query only Query only  Query only    Query only Query only Query only Query only

#### :DIAGnostic:INFO

The commands which can be used to query all information which does not require hardware measurement are under this node.

#### :DIAGnostic:INFO:CCOunt

The commands which can be used to query all counters in the instrument are under this node (Cycle COunt).

#### :DIAGnostic:INFO:CCOunt:ATTenuator 1 | 2 | 3 | 4 | 5 | 6?

The command queries the number of switching processes of the different attenuator stages. The stages are designated with Z1 to Z6 within the instrument. In this command they are differentiated by a numeric suffix whose name corresponds to the number:

Suffix	Name	Function
1	Z1	40-dB stage
2	Z2	20-dB stage
3	Z3	5-dB stage
4	Z4	20-dB stage
5	Z5	10-dB stage
6	Z6	40-dB stage

Example:    :DIAG:INFO:CCO:ATT1?

Response: 1487

**:DIAGnostic:INFO:CCOunt:POWer?**

The command queries the number of switch-on processes.

Example: :DIAG:INFO:CCO:POW?

Response: 258

**:DIAGnostic:INFO:MODules?**

The command queries the modules existing in the instrument with their model and state-of-modification numbers. The response supplied is a list in which the different entries are separated by commas. The length of the list is variable and depends on the equipment of the instrument. Each entry consists of three parts which are separated by means of blanks:

1. Name of module;
2. Variant of module in the form VarXX (XX = 2 digits)
3. Revision of module in the form RevXX (XX = 2 digits)

Example :DIAG:INFO:MOD?

Response: FRO Var01 Rev00, DSYN Var03 Rev12, to

**:DIAGnostic:INFO:OTIME?**

The command reads out the internal operating-hours counter. The response supplies the number of hours the instrument has been in operation up to now.

Example: :DIAG:INFO:OTIM?

Response: 19

**:DIAGnostic:INFO:SDATe?**

The command queries the date of software creation. The response is returned in the form year, month, day.

Example: :DIAG:INFO:SDAT?

Response: 1992, 12, 19

**:DIAGnostic[:MEASure]**

The commands which trigger a measurement in the instrument and return the measured value are under this node.

**:DIAGnostic[:MEASure]:POINt?**

The command triggers a measurement at a measuring point and returns the voltage measured. The measuring point is specified by a numeric suffix (cf. service manual, stock no. 1039.1856.24).

Example: :DIAG:MEAS:POIN2?

Response: 3.52

**:DIAGnostic:XMEM:CHECKsum**

The command for calculating and querying the checksum are provided in this node. Contrary to the display in local mode, the values are returned as decimal numbers.

**:DIAGnostic:XMEM:CHECKsum:CALCulate**

This command triggers the calculation of all four checksums. The results depend on the start and stop addresses selected and on the operating mode of the memory extension. This command is recommended whenever a checksum is to be read out and when setups or memory extension data have been modified since the last calculation.

Example: :DIAG:XMEM:CHEC:CALC

Action without query

**:DIAGnostic:XMEm:CHECKsum[:TOTal]?**

This command queries the overall checksum for the memory extension. Beforehand, the checksum has to be calculated using :CALCulate.

Example: :DIAG:XMEm:CHEC?

Response: 178034

**:DIAGnostic:XMEm:CHECKsum:DATA?**

This command queries the overall checksum for the DATA section of the memory extension data. In the 8M\*1 mode, this checksum is identical with the overall checksum. Beforehand, the checksum has to be calculated using :CALCulate.

Example: :DIAG:XMEm:CHEC:DATA?

Response: 10043

**:DIAGnostic:XMEm:CHECKsum:ATTenuate?**

This command queries the overall checksum for the ATTenuate section of the memory extension data. In the 8M\*1 mode, this checksum is 0. Beforehand, the checksum has to be calculated using :CALCulate.

Example: :DIAG:XMEm:CHEC:ATT?

Response: 97134

**:DIAGnostic:XMEm:CHECKsum:BURSt?**

This command queries the overall checksum for the BURSt section of the memory extension data. In the 8M\*1 mode, this checksum is 0. Beforehand, the checksum has to be calculated using :CALCulate.

Example: :DIAG:XMEm:CHEC:BURS?

Response: 28601

### 3.6.6 DISPLAY-System

This system contains the commands to configure the screen. If system security is activated using command `SYSTem:SECurity ON`, the display cannot be switched on and off arbitrarily (cf. below)

Command	Parameter	Default Unit	Remark
<code>:DISPlay</code> <code>:ANNotation</code> <code>[:ALL]</code> <code>:AMPLitude</code> <code>:FREQuency</code>	ON   OFF ON   OFF ON   OFF		

#### `:DISPlay:ANNotation`

The commands determining whether frequency and amplitude are indicated are under this node.

**Caution:** *With `SYSTem:SECurity ON`, the indications cannot be switched from OFF to ON. In this case `*RST` does not influence the `ANNotation` settings either. With `SYSTem:SECurity OFF`, the `*RST` value is ON for all `ANNotation` parameters.*

#### `:DISPlay:ANNotation[:ALL] ON | OFF`

The command switches the frequency and amplitude indication on or off.

Command `:DISPlay:ANNotation:ALL ON` can only be executed if `SYSTem:SECurity` is set to OFF.

With `SECurity OFF` - `*RST` value is ON.

Example: `:DISP:ANN:ALL ON`

#### `:DISPlay:ANNotation:AMPLitude ON | OFF`

The command switches on or off the amplitude indication.

Command `:DISPlay:ANNotation:AMPLitude ON` can only be executed if `SYSTem:SECurity` is set to OFF.

With `SYSTem:SECurity OFF` - `*RST` value is ON.

Example: `:DISP:ANN:AMPL ON`

#### `:DISPlay:ANNotation:FREQuency ON | OFF`

The command switches on or off the amplitude indication.

Command `:DISPlay:ANNotation:AMPLitude ON` can only be executed if `SYSTem:SECurity` is set to OFF.

With `SYSTem:SECurity OFF` - `*RST` value is ON.

Example: `:DISP:ANN:FREQ ON`



### 3.6.7 FORMat-System

This system contains the commands determining the format of the data the SME returns to the controller. All queries returning a list of numeric data or block data are concerned. With each of these commands, this connection is pointed to in the description.

Command	Parameter	Default Unit	Remark
:FORMat [:DATA] :BORDER	ASCIi   PACKed NORMal   SWAPped		

#### :FORMat[:DATA] ASCii | PACKed

The command specifies the data format, that the SME uses for returning the data. When data are transmitted from the controller to the SME, the SME recognizes the data format automatically. In this case, the value specified here has no significance.

**Note:** *Settings using the FORMat:DATA command are only effective for commands with which this is stated in the command description.*

ASCIi Numeric data are transmitted in plain text, separated by commas.

PACKed Numerical data are transmitted as binary block data. The format of the binary data itself is command-specific. Its description can be found in Section 3.5.5.

Example: :FORM:DATA ASC \*RST value is ASCii

#### :FORMat:BORDER NORMal | SWAPped

This command defines the order of bytes inside a binary block. This concerns only blocks which use the IEEE754 format internally (see section 3.5.5, paragraph "Block Data").

NORMal: The SME expects (for setting commands) and sends (for queries) first the most significant byte of each IEEE-754 floating point number, last the least significant byte. For hosts based on a 80x86 processor this corresponds to the configuration of bytes in the main memory. Thus, no further conversion is required.

SWAPped: The SME expects (for setting commands) and sends (for queries) first the least significant byte of each IEEE754 floating point number, last the most significant byte.

Example: :FORMat:BORDER:NORMal \*RST-value is NORMal

### 3.6.8 MEMory System

This system contains the commands for the memory management of the SME.

Command	Parameter	Default Unit	Remark
:MEMory :NSTates?			Query only

#### :MEMory:NSTates?

The command returns the number of \*SAV/\*RCL memories available. The SME has 50 \*SAV/\*RCL memories in total.

Example: :MEM:NST?

Response: 50

### 3.6.9 OUTPut-System

This system contains the commands specifying the characteristics of the RF output socket and the BLANK socket. The characteristics of the LF socket are specified in the OUTPut2 system.

Command	Parameter	Default Unit	Remark
:OUTPut :AMODe :BLANK :POLarity :IMPedance? :PROTection :CLEar :TRIPped? [:STATe] :PON	AUTO   FIXed  NORMal   INVerted  ON   OFF OFF   UNChanged		Query only  Query only

#### :OUTPut:AMODe AUTO | FIXed

The command switches over the operating mode of the attenuator at the RF output (Attenuator MODe).

AUTO The attenuator is switched whenever possible.

FIXed The attenuator is switched when certain fixed levels are exceeded/fallen below.

Example: :OUTP:AMOD AUTO

\*RST value is AUTO

**:OUTPut:BLANK:POLarity** NORMal | INVerted

The command sets the polarity of the BLANK signal.

NORMal The active BLANK state is indicated by the more positive or higher output voltage.

INVers The active BLANK state is indicated by the more negative or lower output voltage.

Example: :OUTP:BLAN:POL NORM RST value is NORM

**:OUTPut:IMPedance?**

The command queries the impedance of the RF output

. This permits converting the output level between units V and W. The impedances cannot be changed. With the SME, this is the fixed value of 50 Ohm for the RF output.

Example: :OUTP:IMP? Response: 50

**:OUTPut:PROTection**

The commands to configure the protective circuit are under this node. The RF output is protected by a protective circuit which deactivates the output if an overvoltage is supplied from outside. This does not change the value of `OUTPut:STATe`.

**:OUTPut:PROTection:CLEar**

The command resets the protective circuit after it has been triggered. The state of the output is determined by `OUTPut:STATe` again. The command triggers an event and hence has no default setting value.

Example: :OUTP:PROT:CLE

**:OUTPut:PROTection:TRIPped?**

The command queries the state of the protective circuit. The responses mean:

"0" The protective circuit has not responded

"1" The protective circuit has responded

Example: :OUTP:PROT:TRIP? Response: "1"

**:OUTPut[:STATe]** ON | OFF

The command switches on or off the RF output. The RF output can also be switched off by the response of the protective circuit. But this has no influence on this parameter.

**Note:** *In contrast to the PRESET key, command \*RST sets this value to OFF, the output is deactivated.*

Example: :OUTP:STAT ON \*RST value is OFF

**:OUTPut[:STATe]:PON** OFF | UNCHanged

This command selects the state the RF output is to assume after power-on of the unit. It only exists for the RF output. \*RST does not influence the set value.

OFF Output is switched off.

UNCHanged Same state as before switch- off

Example: :OUTP:PON OFF

### 3.6.10 OUTPut2 System

This system contains the commands specifying the characteristics of the LF output socket

Command	Parameter	Default Unit	Remark
<b>:OUTPut2</b> <b>:SOURce</b> <b>:STEReo</b> <b>[:STATe]</b> <b>:VOLTage</b>	0   2 MPX   PILot ON   OFF 0 V to 4 V	V	Option SM-B2 Option SM-B6 Option SM-B6

**:OUTPut2:SOURce 0 | 2**

This command selects which LF generator is connected with the LF output socket (only with option SM-B2 and SM-B6).

0 LF generator 1

2 LF generator 2

\*RST value is 0, LF-generator 1 is connected at the output.

Example: :OUTP2:SOUR 2

**:OUTPut2:SOURce:STEReo MPX | PILot**

The command determines whether the complete stereo multiplex signal (MPX) or only the pilot tone is output. The command is only effective if LF generator2 is in the STEREO operating mode and if LF generator2 is selected for OUTPut2:SOURce as well.

Example: :OUTP2:SOUR:STER MPX

\*RST value is MPX

**:OUTPut2[:STATe] ON | OFF**

The command switches the LF output on or off.

\*RST value is OFF

Example: :OUTP2:STAT ON

**:OUTPut2:VOLTage 0V to 4V**

The command sets the voltage of the LF output. The voltage is a characteristic of the output, not the source. I.e., it is maintained even if another LF generator is connected to the output.

Example: :OUTP2:VOLT 3.0V

\*RST value is 1 V

### 3.6.11 SOURce-System

This system contains the commands to configure the RF signal source. Keyword SOURce is optional, i.e., it can be omitted. The LF signal sources (options SM-B2 and SM-B6) are configured in the SOURce0|2 system (cf. Section 3.6.12).

The following subsystems are realized in the instrument:

Subsystem	Settings
<b>[:SOURce]</b>	
<b>:AM</b>	Amplitude modulation
<b>:CORRection</b>	Correction of the output level
<b>:DM</b>	Digital modulation
<b>:ERMes</b>	ERMES signal
<b>:FLEX</b>	FLEX signal
<b>:FM</b>	Frequency modulation
<b>:FREQuency</b>	Frequencies including sweep
<b>:ILS</b>	Test signals for ILS (Instrument Landing System)
<b>:LIST</b>	LIST operating mode
<b>:MARKer</b>	Marker generation with sweeps
<b>:MBE</b>	Marker signals (Marker Beacon)
<b>:PHASe</b>	Phase between output signal and reference oscillator signal
<b>:PM</b>	Phase modulation
<b>:POCSag</b>	Post Office Code Standardisation Advisory Group
<b>:POWer</b>	Output level, level control and level correction
<b>:PULM</b>	Pulse modulation
<b>:PULSe</b>	Pulse generator
<b>:ROSCillator</b>	Reference oscillator
<b>:STEReo</b>	Stereo modulation
<b>:SWEep</b>	Sweeps
<b>:VOR</b>	Test signals for VOR (VHF Omnidirectional Range)

### 3.6.11.1 SOURce:AM Subsystem

This subsystem contains the commands to control the amplitude modulation. Up to two LF generators which serve as internal modulation sources can be fitted in the instrument (options SM-B2 and SM-B6). Part of their settings is effected under SOURce0|2.

Command	Parameter	Default Unit	Remark
<b>[[:SOURce]</b> <b>:AM</b> <b>[:DEPTH]</b> <b>:EXTernal</b> <b>:COUPling</b> <b>:INTernal1 2</b> <b>:FREQuency</b>  <b>:POLarity</b> <b>:SOURce</b> <b>:STATe</b>	0 to 100PCT AC   DC 400 Hz, 1 kHz, 4 kHz, 15 kHz or 0.1 Hz to 500 kHz or 0.1 Hz to 1 MHz NORMal   INVerted EXT   INT1 2   EXT, INT1 2 ON   OFF	PCT Hz	Option SM-B2 or B6

**[[:SOURce]:AM[:DEPTH]** 0 to 100PCT

The command sets the modulation depth in percent.

\*RST value is 30PCT

Example: :SOUR:AM:DEPT 15PCT

**[[:SOURce]:AM:EXTernal**

The commands to set the external AM input are under this node.

**[[:SOURce]:AM:EXTernal:COUPling** AC | DC

The command selects the type of coupling for the external AM input.

AC The d.c. voltage content is separated from the modulation signal.

DC The modulation signal is not altered.

\*RST value is AC

Example: :SOUR:AM:EXT:COUP AC

**[[:SOURce]:AM:INTernal1|2**

The settings for the internal AM inputs are effected under this node.

INT1 is LF generator 1,

INT2 is LF generator 2.

Here the same hardware is set for AM, PM, FM and SOURce0|2. This means that, for example, the following commands are coupled with each other and have the same effect:

```
SOUR:AM:INT2:FREQ
SOUR:FM2:INT:FREQ
SOUR:PM2:INT:FREQ
SOUR2:FREQ:CW
```

**[[:SOURce]:AM:INTernal1|2:FREQuency** 400 Hz | 1 kHz | 3 kHz | 15 kHz or  
0.1 Hz to 500 kHz (option SM-B2) or  
0.1 Hz to 1MHz (option SM-B6)

The command sets the modulation frequency. Only certain specified ranges are permissible depending on the equipment of the instrument.

If neither SM-B2 nor SM-B6 are fitted, only INT1 is permissible and values 400 Hz, 1 kHz, 3 kHz and 15 kHz are true. With option SM-B2, the specified range from 0.1 Hz to 500 kHz is true, with SM-B6, from 0.1 Hz to 1 MHz. \*RST value is 1 kHz

Example: :SOUR:AM:INT:FREQ 15kHz

**[[:SOURce]:AM:POLarity** NORMal | INVerted

The command selects the polarity of the AM.

NORMal A positive modulation voltage generates a higher output level.

INVerted The AM polarity is inverted.

Example: :SOUR:AM:POL NORM

\*RST value is NORMAL

**[[:SOURce]:AM:SOURce** EXT | INT1|2 | EXT, INT1|2

The command selects the modulation source. INT1 is LF generator 1, INT2 LF generator 2 (option SM-B2 or SM-B6). An external and an internal modulation source can be indicated at the same time (see example). \*RST value is INT1

Example: :SOUR:AM:SOUR INT1, EXT

**[[:SOURce]:AM:STATe** ON | OFF

The command switches amplitude modulation on or off.

\*RST value is OFF

Example: :SOUR:AM:STAT ON

### 3.6.11.2 SOURce:CORRection Subsystem

The CORRection subsystem permits a correction of the output level. The correction is effected by adding user-defined table values to the output level as a function of the RF frequency. In the SME, this subsystem serves to select, transmit and switch on USER-CORRECTION tables (see Chapter 2, Section "User Correction (UCOR)" as well).

Command	Parameter	Default Unit	Remark
[:SOURce] :CORRection [:STATe] :CSET :CATalog? [:SElect] :DATA :FREquency :POWER :DELeTe	ON   OFF  "Name of table"  5 kHz to 1.5 GHz {,5 kHz to 1.5 GHz} -40 dBto 6dB {,-40 dBto 6dB} "Name of table"	    Hz dB	  Query only  SME03E: to 2.2 GHz SME03: to 3 GHz SME06: to 6 GHz

**[:SOURce]:CORRection[:STATe] ON | OFF**

The command switches the table selected using SOURce:CORRection:CSET on or off.

Example: :SOUR:CORR:STAT ON \*RST value is OFF

**[:SOURce]:CORRection:CSET**

The commands to select and edit the UCOR tables are under this node.

**[:SOURce]:CORRection:CSET:CATalog?B**

The command requests a list of UCOR tables. The individual lists are separated by means of commas. This command is a query and has no \*RST value.

Example: :SOUR:CORR:CAT? Answer: "UCOR1" , "UCOR2" , "UCOR3"

**[:SOURce]:CORRection:CSET[:SElect] "Name of table"**

The command selects a UCOR table. This command alone does not yet effect a correction. First the table selected must be activated (cf. :SOURce:CORRection:STATe). If there is no table of this name, a new table is created. The name may contain up to 7 letters. This command triggers an event and hence has no \*RST value.

Example: :SOUR:CORR:CSET:SEL "UCOR1"



**[ :SOURce]:CORRection:CSET:DATA**

The commands to edit the UCOR tables are under this node.

**[ :SOURce]:CORRection:CSET:DATA:FREQuency** 5 kHz to 1.5 GHz {,5 kHz to 1.5 GHz}  
SME03E/03/06: to 2.2/3/6 GHz

The command transmits the frequency data for the table selected using :SOURce:CORRection:CSET. \*RST does not influence data lists.

Example: :SOUR:CORR:CSET:DATA:FREQ 100MHz,102MHz,103MHz,to

**[ :SOURce]:CORRection:CSET:DATA:POWer** -40dB to 6dB {,-40dB to 6dB}

The command transmits the level data for the table selected using :SOURce:CORRection:CSET. \*RST does not influence data lists.

Example: :SOUR:CORR:CSET:DATA:POWer 1dB, 0.8dB, 0.75dB,to

**[ :SOURce]:CORRection:CSET:DELeTe** "Name of table"

The command deletes the table indicated from the instrument memory. This command triggers an event and hence has no \*RST value.

Example: :SOUR:CORR:CSET:DEL "UCOR2"

### 3.6.11.3 SOURce:DM Subsystem

In this subsystem, the types of digital modulation are checked. A difference is made between basic modulations (GMSK, GFSK, QPSK, FSK, 4FSK and FFSK) and complex modulations (ERMES, FLEX, POCSAG). The common characteristics of all basic modulations are set under node [:BASic], the common characteristics of all complex modulations under :COMPLex. An external input, an internal pseudo-random sequence generator and an internal data generator are available as data source for the basic modulations.

**Note:** The signal generator SME42 (Id No. 1038.6002.42) is a special model for ERMES, FLEX, FLEX-TD and POCSAG. The options SME-B11 (DM coder), SME-B12 (DM expanded memory), SME-B41 (FLEX protocol) and SME-B42 (POCSAG protocol) have been integrated in the SME42 as standard.

Only the command MGRoup? and the commands of node SOURce:DM:COMPLex are available when using the SME42.

Command	Parameter	Default Unit	Remark
[:SOURce]			
:DM			Option SME-B11
:MGRoup?			Query only
[:BASic]			
:TYPE	GMSK   GFSK   QPSK   FSK   FSK4   FFSK		
:STATe	ON   OFF		
:SOURce	EXTernal   PRBS   DATA		
:CLOCK			
:MODE	BIT   SYMBol		
:POLarity	NORMal   INVerted		
:SOURce	INTernal   COUPLed		
:DATA			
:CATalog?			Query only
:DELeTe	"Name"		
:ALL			
:FREE?			Query only
:SELeCt	"Name"		
:DATA	0   1 {, 0   1}		
:POINts?			Query only
:ATTenuate	0   1 {, 0   1}		
:POINts?			Query only
:BURSt	0   1 {, 0   1}		
:POINts?			Query only
:ALEVel	0 to 60 dB	dB	
:MODE	NORM   MAX   OFF		
:XMEM			Option SME-B12
:START	1 to 8388478   1 to 1048558		
:LENGth	3 to 8388480   3 to 1048560		
:AUTO	ON   OFF		
:MODE	DATA   ALL		
:RECOrd			No query
:TRIGger	ON   OFF		
:SLOPe	POSitive   NEGative		
:PRBS			
[:LENGth]	9   15   20   21   23		

Command	Parameter	Default Unit	Remark
[[:SOURce]]			
:DM			Option SME-B11
:COMPLex			
:CLOCK			
[[:SOURce]]	INT   EXT		
:GMSK			
:STANDARD	GSM   PCN   CDPD   MC9   MOBitex   DSRR   MD24 to MD192		No query
:BRATE	2.4 to 1000kb/s	b/s	
:FILTER	0.2   0.25   0.3   0.4   0.5		
:DCODEr	ON   OFF		
:GSLope	ON   OFF		
:POLarity	NORMAL   INVERTed		
:GFSK			
:STANDARD	DECT   CT2   CT3		No query
:BRATE	10 to 585 kb/s   640 to 1170 kb/s	b/s	
:FILTER	0.4   0.5   0.6		
:DEVIation	14   14.4   18   20   25.2   160   180   202   259   288   317   403 kHz	Hz	
:DSLope	ON   OFF		
:POLarity	NORMAL   INVERTed		
:QPSK			
:STANDARD	NADC   PDC   TFTS   APCO   TETRa   INMarsat   MSAT		No query
:TYPE			
:BRATE	QPSK   OQPSk   PI4Qpsk   PI4Dqpsk	b/s	
:CODing	1 to 24.3 kbps   27.0 to 48.6 kbps		
:FILTER	NADC   TFTS   PDC   APCO   TETRa   INMarsat   MSAT		
:POLarity			
:FSK	COS SCOS, 0.35 0.4 0.5 0.6   COS,0.2		
:STANDARD	NORMAL   INVERTed		No query
:BRATE	POCSag512   POCSag1200   POCSag2400   CITYruf512   CITYruf1200   CITYruf2400   FLEX1600   FLEX3200	b/s	
:DEVIation		Hz	
:FILTER	0.05 to 1900 kb/s   0.05 to 90 kb/s		
:POLarity	0.01 to 400 kHz		
:FSK4	GAUSs, 2.73   BESSel, 1.22 2.44   OFF		
:STANDARD	NORMAL   INVERTed		No query
:CODing			
:BRATE	ERMes   APCO   MODacom   FLEX3200   FLEX6400	b/s	
:DEVIation	ERMes   APCO   MODacom   FLEX	Hz	
:FILTER	1 to 24.3 kb/s   27.0 to 48.6 kb/s		
:POLarity	0.01 to 400 kHz		
:FFSK	BESSel, 1.22 1.25 2.44   COS SCOS, 0.2		
:STANDARD	NORMAL   INVERTed		No query
:DEVIation		Hz	
:BRATE	POCSag 1.5   2.0   3.0   3.5   4.0   4.5 kHz 0.05 to 90 kb/s	b/s	

**[[:SOURce]:DM:MGRoup?**

The command queries the selected type of modulation. „BAS“ is returned for the basic modulations GFSK, GMSK, QPSK, FSK, FSK4, and FFSK. „COMP“ is returned for the complex protocols ERMES, FLEX, and POCSAG. The command is a query and hence has no \*RST value.

Example: :SOUR:DM:MGR? Response: „BAS“

**[[:SOURce]:DM[:BASic]**

The commands that are also valid for modulations GMSK, GFSK, DQPSK, FSK, FSK4 and FFSK are under this node.

**[[:SOURce]:DM[:BASic]:TYPE GMSK | GFSK | QPSK | FSK | FSK4 | FFSK**

The command selects the type of basic modulation.

GMSK Gaussian Minimum Shift Keying

GFSK Gaussian Frequency Shift Keying

QPSKQuad Phase Shift Keying, a special form of PSK. The key word :DQPSk is also accepted.

FSK Frequency modulation with exactly two states

FSK4 Frequency modulation with exactly four states, designated as 4 FSK in the manual control.

FFSK Fast Frequency Shift Keying, a special form of FSK

Example: :SOUR:DM:BAS:TYPE FSK \*RST value is GMSK

**[[:SOURce]:DM[:BASic]:STATE ON | OFF**

The command switches on or off the modulation selected under :SOURce:DM[:BASic]:TYPE.

Example: :SOUR:DM:BAS:STAT OFF \*RST value is OFF

**[[:SOURce]:DM[:BASic]:SOURce EXTERNAL | PRBS | DATA**

The command selects the data source.

**Note:** Even if PRBS is selected, the burst output and the level reduction continue to be controlled by the list selected under :SOURce:DM[:BASic]:DATA.

Example: :SOUR:DM:BAS:SOUR PRBS \*RST value is PRBS

**[[:SOURce]:DM[:BASic]:CLOCK**

The commands to set the data source for the time base used are under this node

**[[:SOURce]:DM[:BASic]:CLOCK:MODE BIT | SYMBol**

The command sets the clock operating mode. Bit and symbol clock pulse are only different in the case of modulations possessing more than two states, i.e. requiring more than one bit to code each state. Hence the command only has an effect on QPSK and FSK4.

BIT For each bit, a complete clock cycle is executed.

SYMBOL A complete clock cycle is executed for n bits each (one symbol) (symbol clock pulse).  
\*RST value is BIT

**Note:** This command is also used for reading data from the extended memory XMEM which is done either serially from the data list or in parallel from the data list together with the burst list. Therefore, if all symbols are stored in the data list in a 2-bit code each (X and Y), only BIT, not SYMBOL must be selected. This implies also that the command DATA:XMEM:MODE DATA (no ATTenuate and BURSt list available) is inconsistent with DM:CLOC:MODE SYMBOL when XMEM is used.

Example: :SOUR:DM:BAS:CLOC:MODE BIT

**[[:SOURce]:DM[:BASic]:CLOCK:POLarity NORMal | INVerted**

The command sets the polarity of the time base used.

**NORMal** The data are accepted with a rising edge (external clock) or can be tapped at the DATA socket with a rising edge (internal clock).

**INVerted** The data are accepted with a falling edge (external clock) or can be tapped at the DATA socket with a falling edge (internal clock).

Example: :SOUR:DM:BAS:CLOC:POL NORM \*RST value is NORMal

**[[:SOURce]:DM[:BASic]:CLOCK:SOURce INTernal | COUPled**

The command selects the source for the DATA clock.

**INTernal** The internal clock generator is used. The CLOCK socket is switched to act as an output.

**COUPled** The function of the CLOCK socket depends on the function of the DATA socket. This means that with an external supply of the data, the clock has to be supplied externally, with internal data generation the instrument itself generates the clock pulse. \*RST value is COUPled

Example: :SOUR:DM:BAS:CLOC:SOUR INT

**[[:SOURce]:DM[:BASic]:DATA**

The commands to set the data generator are under this node. The bit rate at which the data are output is to be set under the individual modulations.

The DM lists consists of a DATA, BURSt and ATTenuate content. The list contents must all be of the same length except for contents of length 1. With QPSK, the number of entries has to be an integer in addition. This is interpreted as if the content had the same length as the other contents and all values were equal to the first value.

However, this is not valid for list "XMEM" offering access to the memory extension (cf. node SOURce:DM:BAS:DATA:XMEM).

**[[:SOURce]:DM[:BASic]:DATA:CATalog?**

The command queries the data lists available. The response supplied is an enumeration of the data lists separated by commas. \*RST has no influence on data lists.

Example: :SOUR:DM:BAS:DATA:CAT? Answer: "DLIST1", "DLIST2", "DLIST3"

**[[:SOURce]:DM[:BASic]:DATA:DELeTe "Name"**

This command deletes the data list indicated. \*RST has no influence on data lists.

Example: :SOUR:DM:BAS:DATA:DEL "DLIST2"

**[[:SOURce]:DM[:BASic]:DATA:DELeTe:ALL**

This command deletes all data lists, with the exception of list "XMEM" (cf Chapter 2, Section "DM Memory Extension"). \*RST has no influence on data lists.

Example: :SOUR:DM:BAS:DATA:DEL:ALL

**[[:SOURCE]:DM[:BASic]:DATA:FREE?**

This command deletes all data lists, with the exception of list "XMEM" (cf Chapter 2, Section "DM Memory Extension"). \*RST has no influence on data lists.

Example: :SOUR:DM:BAS:DATA:FREE? Answer: 2400, 200

**[[:SOURCE]:DM[:BASic]:DATA:SElect "Name"**

This command selects the data list indicated. Working with the data list is only possible after selection. If the list indicated does not exist yet, it is generated. The name may contain up to seven letters.

List "XMEM" calls the DM memory extension (option SME-B12) (cf. Chapter 2, Section "DM memory extension"). \*RST has no influence on data lists.

Example: :SOUR:DM:BAS:DATA:SEL "DLIST1"

**[[:SOURCE]:DM[:BASic]:DATA:DATA 0|1{,0|1}**

This command transmits the bit data the data generator outputs bit by bit to the data list selected or to the memory area of the DM memory extension indicated (selection list "XMEM", definition of the memory area under :DM:BAS:DATA:XMEM). Only numbers 0 or 1 are permissible. The data can also be transmitted as block data. 8 bit data each are combined to form a byte, with the first bit date having to be saved in the most significant bit of the first data byte. The following examples of commands are equal. If the data are to be returned as block data, this has to be set in the FORMat system. In the case of binary-block transmission, only lists with a length of integral multiples of 8 can be loaded; when the data are returned, the last byte is filled if necessary. RST has no influence on data lists.

Example:

:SOUR:DM:BAS:DATA:DATA 0,1,1,0,0,0,0,1,0,1,0,1,1,0,0,0,0,0,1,0,1,1,0,1  
:SOUR:DM:BAS:DATA:DATA #13aX- (s.a. 'block data' in chap. 'Parameter')

**[[:SOURCE]:DM[:BASic]:DATA:DATA:POINts?**

This command queries the length (in bits) of the DATA list presently selected. The command is a query and thus has no \*RST value.

Example: :SOUR:DM:BAS:DATA:DATA:POIN? Answer: 200

**[[:SOURCE]:DM[:BASic]:DATA:ATTenuate 0|1{,0|1}**

This command transmits the bit edgedata the data generator uses for the decision of whether the level is to be reduced or not (see SOURCE:DM:BAS:DATA:ALEVel as well). List "XMEM", DM memory extension, can only be written into with ATTenuate data if DM:BAS:DATA:XMEM:MODE is set to ALL. Only numbers 0 or 1 are permissible. The data can also be transmitted as block data (cf. DATA). \*RST has no influence on data lists.

Example: :SOUR:DM:BAS:DATA:ATT 1,1,1,0,0,0,0,...

**[[:SOURCE]:DM[:BASic]:DATA:ATTenuate:POINts?**

This command queries the length (in bits) of the ATTenuate list presently selected. The command is a query and thus has no \*RST value.

Example: :SOUR:DM:BAS:DATA:ATT:POIN? Answer: 200

**[[:SOURce]:DM[:BASic]:DATA:BURSt 0 | 1 {, 0 | 1}**

The command transmits the burst data output at the BURSt output socket. List "XMEM", DM memory extension, can only be written into with BURSt data if DM:BAS:DATA:XMEM:MODE is set to ALL. Only numbers 0 or 1 are permissible. "1" corresponds to high level at the burst socket. The data can also be transmitted as block data (cf. DATA). \*RST has no influence on data lists.

Example: :SOUR:DM:BAS:DATA:BURSt 0,0,0,1,1,1,1

**[[:SOURce]:DM[:BASic]:DATA:BURSt:POINts?**

This command queries the length (in bits) of the BURSt list presently selected. The command is a query and thus has no \*RST value.

Example: :SOUR:DM:BAS:DATA:BURSt:POINts? Answer: 200

**[[:SOURce]:DM[:BASic]:DATA:ALEVel 0 to 60 dB**

This command (Attenuate LEVel) specifies the value in dB by which the level is reduced if a "1" occurs in the ATTenuate list presently active. The command is only active in the setting DM:BAS:DATA:ALEVel:MODE NORM.

**Note:** The command also specifies the level reduction of the complex modulation POCsAG.

Example: :SOUR:DM:BAS:DATA:ALEVel 3dB \*RST value is 0 dB

**[[:SOURce]:DM[:BASic]:DATA:ALEVel:MODE NORM | MAX | OFF**

This command specifies the operating mode for the level reduction. In GMSK modulation, the command is only active in the setting DM:GMSK:GSLope = OFF.

NORM The level reduction is specified by the command DM:BAS:DATA:ALEVel.

MAX The level reduction is set to a maximum attenuation of >80 dB.

OFF No level reduction (DM:DATA:ALEV is without effect).

Example: :SOUR:DM:BAS:DATA:ALEVel:MODE MAX \*RST value is NORM

**[[:SOURce]:DM[:BASic]:DATA:XMEM**

The commands to configure option SME-B12, DM memory extension are under this node.

**[[:SOURce]:DM[:BASic]:DATA:XMEM:STARt 1 to 8388478 (XMEM:MODE = DATA) |  
1 to 1048558 (XMEM:MODE = ALL)**

This command indicates the start address for reading and outputting the data.

Example: :SOUR:DM:BAS:DATA:XMEM:STARt 256 Not changed by \*RST

**[[:SOURce]:DM[:BASic]:DATA:XMEM:LENGth 3 to 8388480 (XMEM:MODE = DATA) |  
3 to 1048560 (XMEM:MODE = ALL)**

This command indicates the length of the data sequence to be input or output. The command is only effective if :SOUR:DM:BAS:DATA:XMEM:LENG:AUto is set to OFF. The length maximally possible depends on the selected mode of the memory space allocation and on the selected start address (cf. Chapter 2, Section "DM Memory Extension"). The minimal length is 3.

Example: :SOUR:DM:BAS:DATA:XMEM:LENG 524280 Not changed by \*RST

**[[:SOURCE]:DM[:BASic]:DATA:XMEM:LENGth:AUTO ON | OFF**

This command switches the automatic length identification in recording the data on or off. The command is only effective with a data transmission via IEC bus, however, if the data are recorded from an external source, it is not.

ON The transmitted data specify the length of the data sequence. The instrument adjusts the value of LENGth accordingly.

OFF LENGth specifies the length of the sequence. The instrument ignores surplus data; if the data quantity is too small, it copies as many data from the beginning of the sequence as is necessary to achieve the specified sequence length.

Example: :SOUR:DM:BAS:DATA:XMEM:LENG:AUTO OFF

\*RST value is ON

**[[:SOURCE]:DM[:BASic]:DATA:XMEM:MODE DATA | ALL**

This command specifies the memory space allocation.

DATA The memory is 1 bit broad and only contains DATA data. The memory depth is 8 MBit.

ALL The memory is 3 bits broad and contains lists of all three types of data (DATA, ATTenuate and BURSt) The memory depth is 1 MBit.

Example: :SOUR:DM:BAS:DATA:XMEM:MODE DATA

Not changed by \*RST

**[[:SOURCE]:DM[:BASic]:DATA:XMEM:RECOrd**

This command starts the recording of external data. The data are directly transferred to the memory extension, list XMEM. The recording automatically stops when the end address is reached. The recording can be aborted using command :ABORt:XMEM. The setting under :DM:BAS:DATA :XMEM:LENG:AUTO has no influence. The external data generator can be synchronized via the CLOCK output of the SME. The command triggers an event and thus has no \*RST value.

Example: :SOUR:DM:BAS:DATA:XMEM:REC

**[[:SOURCE]:DM[:BASic]:DATA:XMEM:TRIGger ON | OFF**

This command switches the external trigger facility on or off.

ON The run of the list is triggered by an external trigger signal. Each trigger signal starts a new run, which starts with the start address.

OFF The external trigger mode is switched off.

Example: :SOUR:DM:BAS:DATA:XMEM:TRIG OFF

\*RST value is OFF

**[[:SOURCE]:DM[:BASic]:DATA:XMEM:TRIGger:SLOPe POSitive | NEGative**

This command selects the active edge of the external trigger signal.

POSitive The run of the list starts with the positive edge of the trigger signal.

NEGative The run of the list starts with the negative edge of the trigger signal.

Example: :SOUR:DM:BAS:DATA:XMEM:TRIG:SLOP POS

\*RST value is POSitive

**[[:SOURCE]:DM[:BASic]:PRBS**

The commands to set the pseudo random sequence generator are under this node.



**[:SOURce]:DM[:BASic]:PRBS:LENGth 9 | 15 | 20 | 21 | 23**

The command specifies the length of the pseudo random sequence according to the following equation:

$$\text{Length} = (2^{\text{LENGth}}) - 1$$

Example: `:SOUR:DM:BAS:PRBS:LENG 9`

\*RST value is 9 Bit

**:SOURce]:DM:COMPLex:CLOCK:SOURce INT | EXT**

The command selects the clock source for radiocommunication services ERMes, FLEX, REFLEX and POCSag.

**INT** The clock required for signal generation is generated internally. The CLOCK connector is switched to be an output.

**EXT** The clock required for signal generation is applied to the CLOCK connector.

Example: `:SOUR:DM:COMP:CLOC:SOUR INT`

\*RST value is INT

**[:SOURce]:DM:GMSK**

The commands to set the data source for the digital type of modulation GMSK are under this node. GMSK (Gaussian Minimum Shift Keying) always has exactly two states. The bit rate of the data source is fixedly set, the phase displacement as well.

**[:SOURce]:DM:GMSK:STANdard GSM|PCN | CDPD | MC9 | MOBitex | MD24N | MD24W | MD36N | MD36W | MD48N | MD48W | MD80W | MD96N | MD96W | MD100W | MD120W | DSRR | DSRR4K**

This short-form command sets the parameters shown in the table to the values specified by the standards (cf. table). The command is an abbreviation of the commands listed in the table. Hence it has no query form or \*RST value.

Short command	Command sequence
<code>:DM:GMSK:STANdard GSM   PCN</code>	<code>:DM:GMSK:FILTer 0,3 :DM:GMSK:BRATe 270,833kb/s :DM:GMSK:DCODer ON :DM:GMSK:POLarity NORM</code>
<code>:DM:GMSK:STANdard CDPD   MD192</code>	<code>:DM:GMSK:FILTer 0,5 :DM:GMSK:BRATe 19,2 kb/s :DM:GMSK:DCODer OFF :DM:GMSK:POLarity NORM</code>
<code>:DM:GMSK:STANdard MC9</code>	<code>:DM:GMSK:FILTer 0,3 :DM:GMSK:BRATe 8 kb/s :DM:GMSK:DCODer ON :DM:GMSK:POLarity NORM</code>
<code>:DM:GMSK:STANdard MOBitex   MD80N</code>	<code>:DM:GMSK:FILTer 0,3 :DM:GMSK:BRATe 8 kb/s :DM:GMSK:DCODer OFF :DM:GMSK:POLarity NORM</code>
<code>:DM:GMSK:STANdard MD24N</code>	<code>:DM:GMSK:FILTer 0,3 :DM:GMSK:BRATe 2,4 kb/s :DM:GMSK:DCODer OFF :DM:GMSK:POLarity NORM</code>

[:SOURce]:DM:GMSK:STANDARD

Short command	Command sequence
:DM:GMSK:STANDARD MD24W	:DM:GMSK:FILTer 0,5 :DM:GMSK:BRATe 2,4 kb/s :DM:GMSK:DCODer OFF :DM:GMSK:POLarity NORM
:DM:GMSK:STANDARD MD36N	:DM:GMSK:FILTer 0,3 :DM:GMSK:BRATe 3,6 kb/s :DM:GMSK:DCODer OFF :DM:GMSK:POLarity NORM
:DM:GMSK:STANDARD MD36W	:DM:GMSK:FILTer 0.5 :DM:GMSK:BRATe 23.6 kb/s :DM:GMSK:DCODer OFF :DM:GMSK:POLarity NORM
:DM:GMSK:STANDARD MD48N	:DM:GMSK:FILTer 0.3 :DM:GMSK:BRATe 4.8 kb/s :DM:GMSK:DCODer OFF :DM:GMSK:POLarity NORM
:DM:GMSK:STANDARD MD48W	:DM:GMSK:FILTer 0.5 :DM:GMSK:BRATe 4.8 kb/s :DM:GMSK:DCODer OFF :DM:GMSK:POLarity NORM
:DM:GMSK:STANDARD MD48W	:DM:GMSK:FILTer 0.5 :DM:GMSK:BRATe 4.8 kb/s :DM:GMSK:DCODer OFF :DM:GMSK:POLarity NORM
:DM:GMSK:STANDARD MD80W	:DM:GMSK:FILTer 0.5 :DM:GMSK:BRATe 8 kb/s :DM:GMSK:DCODer OFF :DM:GMSK:POLarity NORM
:DM:GMSK:STANDARD MD96N	:DM:GMSK:FILTer 0.3 :DM:GMSK:BRATe 9.6 kb/s :DM:GMSK:DCODer OFF :DM:GMSK:POLarity NORM
:DM:GMSK:STANDARD MD96W	:DM:GMSK:FILTer 0.5 :DM:GMSK:BRATe 9.6 kb/s :DM:GMSK:DCODer OFF :DM:GMSK:POLarity NORM
:DM:GMSK:STANDARD MD100W	:DM:GMSK:FILTer 0.5 :DM:GMSK:BRATe 10.0 kb/s :DM:GMSK:DCODer OFF :DM:GMSK:POLarity NORM
:DM:GMSK:STANDARD MD120W	:DM:GMSK:FILTer 0.5 :DM:GMSK:BRATe 12.0 kb/s :DM:GMSK:DCODer OFF :DM:GMSK:POLarity NORM
:DM:GMSK:STANDARD DSRR   MD160	:DM:GMSK:FILTer 0.3 :DM:GMSK:BRATe 16.0 kb/s :DM:GMSK:DCODer OFF :DM:GMSK:POLarity NORM
:DM:GMSK:STANDARD DSSR4K	:DM:GMSK:FILTer 0.5 :DM:GMSK:BRATe 4.0 kb/s :DM:GMSK:DCODer OFF :DM:GMSK:POLarity NORM

Example: :SOUR:DM:GMSK:STAN PCN

**[[:SOURce]:DM:GMSK:BRATe 2.4 kb/s to 1000 kb/s**

The command sets the bit rate of the modulation. The value of `SOURce:DM:GMSK:FiLTeR` is adapted if necessary to obtain a valid setting. Valid settings are listed in the table to Section "GMSK Modulation" in Chapter 2.

Example: `:SOUR:DM:GMSK:BRAT 8000b/s` \*RST value is 270.833kb/s

**[[:SOURce]:DM:GMSK:DCODer ON | OFF**

Command (Differential Encoder) specifies the state coding.

ON Difference coding of the states according to regulation GSM is switched on.

OFF No difference coding. \*RST value is ON

Example: `:SOUR:DM:GMSK:DCOD OFF`

**[[:SOURce]:DM:GMSK:FiLTeR 0.2 | 0.25 | 0.3 | 0.4 | 0.5**

The command specifies  $B \times T$  of the Gaussian filter used. The value of `SOURce:DM:GMSK:FiLTeR` is adapted if necessary to obtain a valid setting.

Valid settings are listed in the table to Section "GMSK Modulation" in Chapter 2.

Example: `:SOUR:DM:GMSK:FiLT 0.2` \*RST value is 0.3

**[[:SOURce]:DM:GMSK:GSLope ON | OFF**

The command specifies the level reduction for the modulation.

ON The rise and fall time of the level reduction correspond to GSM power ramping.

OFF Command `DM:DATA:ALEVeL:MODE` specifies the level reduction.

Example: `:SOUR:DM:GMSK:GSL ON` \*RST value is OFF

**[[:SOURce]:DM:GMSK:POLarity NORMal | INVerted**

The command specifies the polarity of the modulation.

NORMal A "1" from the data source generates a positive deviation, a "0" a negative deviation.

INVerted A "1" from the data source generates a negative deviation, a "0" a positive deviation. \*RST value is NORMal

Example: `:SOUR:DM:GMSK:POL INV`

**[[:SOURce]:DM:GFSK**

The commands to set the data source for the digital type of modulation GFSK are under this node. GFSK (Gaussian Frequency Shift Keying) always has exactly two states.

**[[:SOURce]:DM:GFSK:STANdard DECT | CT2 | CT3**

This short-form command sets the parameters shown in the table to the values specified by the standards (cf. table). The command is an abbreviation of the commands listed in the table. Hence it neither has a query form nor an \*RST value.

Short command	Command sequence
:DM:GFSK:STANdard DECT	:DM:GFSK:FILTer 0.5 :DM:GFSK:BRATe 1125 kb/s :DM:GFSK:DEVIation 288kHz :DM:GFSK:POLarity NORM
:DM:GFSK:STANdard CT2	:DM:GFSK:FILTer 0.5 :DM:GFSK:BRATe 72 kb/s :DM:GFSK:DEVIation 18 kHz :DM:GFSK:POLarity NORM
:DM:GFSK:STANdard CT3	:DM:GFSK:FILTer 0.5 :DM:GFSK:BRATe 640 kb/s :DM:GFSK:DEVIation 160 kHz :DM:GFSK:POLarity NORM

Example: :SOUR:DM:GFSK:STAN DECT

**[[:SOURce]:DM:GFSK:BRATe 10 to 585 kb/s and 640 to 1170 kb/s**

The command sets the bit rate for the modulation in bits per second. With setting FILTer 0.5 and DEVIation 14.0 kHz or 25.2 kHz the range is 0.05...90 kb/s

Example: :SOUR:DM:GFSK:BRAT 1122 kb/s \*RST value is 1170 kb/s

**[[:SOURce]:DM:GFSK:DEVIation 14 |14.4 |18 |20.0 |25.2 |160 |180 |202 |259 |288 |317 |403 kHz**

The command sets the frequency deviation of the modulation. The value of :SOURce:DM:GMSK:DEVIation is adapted if necessary in order to achieve a valid setting.

Valid settings are:	DEVIation	FILTer	DEVIation	FILTer
	14 kHz	0.5	180 kHz	0.5
	14.4 kHz	0.7	202 kHz	0.5
	18 kHz	0.5	259 kHz	0.5
	20.0 kHz	0.5	288 kHz	0.4, 0.5, 0.6
	25.2 kHz	0.4, 0.5	317 kHz	0.5
	160 kHz	0.5	403 kHz	0.5

Example: :SOUR:DM:GMSK:DEV 288E3 \*RST value is 288 kHz

**[[:SOURce]:DM:GFSK:FILTer 0.4 | 0.5 | 0.6 | 0.7**

The command specifies B x T of the filter used. The value of :SOURce:DM:GFSK:DEVIation is adapted if necessary in order to achieve a valid setting

Valid settings are:	FILTer	DEVIation
	0.4	25.2 kHz, 288 kHz
	0.5	14 kHz, 18 kHz, 20.0 kHz, 25.2 kHz, 160 kHz, 180 kHz, 202 kHz, 259 kHz, 288 kHz, 317 kHz, 403 kHz
	0.6	288 kHz
	0.7	14.4 kHz

\*RST value is 0.5

Example: :SOUR:DM:GFSK:FILT 0.4

**[[:SOURce]:DM:GFSK:DSLope ON | OFF**

The command specifies the level reduction for the modulation.

ON The rise and fall time of the level reduction correspond to DECT power ramping.

OFF Command DM:DATA:ALEVEL:MODE specifies the level reduction.

Example: :SOUR:DM:GFSK:DSL ON \*RST value is OFF

**[[:SOURce]:DM:GFSK:POLarity NORMal | INVerted**

The command specifies the polarity of the modulation.

NORMal A "1" from the data source results in a positive deviation

INVerted A "1" from the data source results in a negative deviation

Example: :SOUR:DM:GMSK:POL INV \*RST value is NORMal

**[[:SOURce]:DM:QPSK**

The commands to set the data source for the digital type of modulation QPSK ( Quad Phase Shift Keying) are under this node. The key word :DQPSK is also accepted..

**[[:SOURce]:DM:QPSK:STANdard NADC | PDC | TFTS | TETRa | APCO | MSAT | INMarsat**

This short-form command sets parameters shown in the table to the values specified by standards (cf. table). The command is an abbreviation of the commands listed in the table. Hence it neither has a query form nor an \*RST value.

NADCNorth American Digital Cellular

PDC Personal Digital Cellular

TFTS Terrestrial Flight Telephone System

TETRa Trans European Trunk Radio

APCO25 Association of Public Safety Communications Officers, Project 25

MSATMobile Satellite

INMarsat International Maritime Satellite

**[[:SOURce]:DM:QPSK:STANdard**

Short command	Command sequence
:DM:QPSK:STANdard NADC	:DM:QPSK:TYPE PI4Dqpsk :DM:QPSK:BRATe 48.6 kb/s :DM:QPSK:CODing NADC :DM:QPSK:FILTer SCOS, 0.35 :DM:QPSK:POLarity NORM
:DM:QPSK:STANdard APCO	:DM:QPSK:TYPE PI4Dqpsk :DM:QPSK:BRATe 9.6 kb/s :DM:QPSK:CODing NADC :DM:QPSK:FILTer COS, 0.2 :DM:QPSK:POLarity NORM
:DM:QPSK:STANdard PDC	:DM:QPSK:TYPE PI4Dqpsk :DM:QPSK:BRATe 42 kb/s :DM:QPSK:CODing NADC :DM:QPSK:FILTer SCOS, 0.5 :DM:QPSK:POLarity NORM

**:SOURce]:DM:QPSK:STANdard**

:DM:QPSK:STANdard TETRa	:DM:QPSK:TYPE PI4Dqpsk :DM:QPSK:BRATe 36 kb/s :DM:QPSK:CODing NADC :DM:QPSK:FILTer SCOS, 0.35 :DM:QPSK:POLarity NORM
:DM:QPSK:STANdard TFTS	:DM:QPSK:TYPE PI4Dqpsk :DM:QPSK:BRATe 44.2 kb/s :DM:QPSK:CODing TFTS :DM:QPSK:FILTer SCOS, 0.4 :DM:QPSK:POLarity NORM
:DM:QPSK:STANdard MSAT	:DM:QPSK:TYPE QPSK :DM:QPSK:BRATe 6.75 kb/s :DM:QPSK:CODing MSAT :DM:QPSK:FILTer SCOS, 0.6 :DM:QPSK:POLarity NORM
:DM:QPSK:STANdard INMarsat	:DM:QPSK:TYPE 0QPSk :DM:QPSK:BRATe 8 kb/s :DM:QPSK:CODing INMarsat :DM:QPSK:FILTer SCOS, 0.6 :DM:QPSK:POLarity NORM

Example: :SOUR:DM:QPSK:STAN PDC

**[[:SOURce]:DM:QPSK:TYPE QPSK | 0QPSk | PI4Qpsk | PI4Dqpsk**

The command specifies the used QPSK modulation type in detail.

Example: :SOUR:DM:QPSK:TYPE QPSK

\*RST value is PI4Dqpsk

**[[:SOURce]:DM:QPSK:BRATe 1 to 24.3 kb/s and 27.0 to 48.6 kb/s**

The command indicates the bit rate for the modulation in bits per second. The resolution is 100 b/s.

Example: :SOUR:DM:QPSK:BRAT 42kb/s

\*RST value is 48.6 kb/s

**[[:SOURce]:DM:QPSK:CODing NADC | PDC | TFTS | TETRa | APCO | MSAT | INMarsat**

The command specifies the coding between the binary data and the generated signal (difference coding).

Example: :SOUR:DM:QPSK:COD NADC

\*RST value is NADC

**[[:SOURce]:DM:QPSK:FILTer COSine|SCOSine , 0.35|0.4|0.5|0.6 | COSine, 0.2**

The command specifies the filter characteristics (characteristic and "roll-off factor"). Values COSine (cosine) and SCOSine (square root cosine) are permissible for characteristic. For roll-off, 0.2, 0.35, 0.4, 0.5 and 0.6 are permissible.

Example: :SOUR:DM:QPSK:FILT COS, 0.35.

\*RST value is SCOSine, 0.35

**[[:SOURce]:DM:QPSK:POLarity NORMal | INVerted**

The command specifies the polarity of the modulation.

- NORMal A "1" from the data source generates a positive deviation
- INVerted A "1" from the data source generates a negative deviation

Example: :SOUR:DM:QPSK:POL NORM

\*RST value is NORMal

**[[:SOURce]:DM:FSK**

The commands to set the data source for the digital frequency modulation are under this node. FSK (Frequency Shift Keying) always has exactly two states. In contrast to the other types of modulation, there are trigger commands for FSK and FSK4 which also permit a single processing of the data list (cf. TRIGGER system, Section 3.6.16).

**[[:SOURce]:DM:FSK:STANdard** POCsag512| POCsag1200| POCsag2400| CItYruf512|  
 CItYruf1200| CItYruf2400 | FLEX1600 | FLEX3200

This short-form command sets parameters shown in the table to the values specified by the standards (cf. table). The command is an abbreviation of the commands listed in the table. Hence it neither has a query form nor an \*RST value.

Short command	Command sequence
:DM:FSK:STANdard POCsag512	:DM:FSK:BRATe 512 :DM:FSK:DEVIation 4.5 kHz :DM:FSK:FILTeR GAUSS, 2.73 :DM:FSK:POLarity INVeRted
:DM:FSK:STANdard POCsag1200	:DM:FSK:BRATe 1200 :DM:FSK:DEVIation 4.5 kHz :DM:FSK:FILTeR GAUSS, 2.73 :DM:FSK:POLarity INVeRted
:DM:FSK:STANdard POCsag2400	:DM:FSK:BRATe 2400 :DM:FSK:DEVIation 4.5 kHz :DM:FSK:FILTeR GAUSS, 2.73 :DM:FSK:POLarity INVeRted
:DM:FSK:STANdard CItYruf512	:DM:FSK:BRATe 512 :DM:FSK:DEVIation 4 kHz :DM:FSK:FILTeR GAUSS, 2.73 :DM:FSK:POLarity INVeRted
:DM:FSK:STANdard CItYruf1200	:DM:FSK:BRATe 1200 :DM:FSK:DEVIation 4 kHz :DM:FSK:FILTeR GAUSS, 2.73 :DM:FSK:POLarity INVeRted
:DM:FSK:STANdard CItYruf2400	:DM:FSK:BRATe 2400 :DM:FSK:DEVIation 4 kHz :DM:FSK:FILTeR GAUSS, 2.73 :DM:FSK:POLarity INVeRted
:DM:FSK:STANdard FLEX1600	:DM:FSK:BRATe 1600 :DM:FSK:DEVIation 4.8 kHz :DM:FSK:FILTeR BESSel, 2.44 :DM:FSK:POLarity INVeRted
:DM:FSK:STANdard FLEX3200	:DM:FSK:BRATe 3200 :DM:FSK:DEVIation 4.8 kHz :DM:FSK:FILTeR BESSel, 1.22 :DM:FSK:POLarity INVeRted

Example: :SOUR:DM:FSK:STAN POCs512

**[[:SOURce]:DM :FSK:BRATe** 0.05 to 1900 kb/s (with FILTeR OFF),  
 0.05 to 90 kb/s (with FILTeR switched on)

The command sets the bit rate for the modulation in bits per second. If this value does not correspond to the standard selected, the FILTeR is deactivated automatically (OFF).

Example: :SOUR:DM:FSK:BRAT 2400 \*RST value is 1200b/s

**[[:SOURce]:DM:FSK:DEVIation** 0 to 400 kHz

This command sets the frequency deviation of the modulation. If this value does not correspond to the standard selected, the FILTeR is deactivated automatically (OFF).

Example: :SOUR:DM:FSK:DEV 3kHz \*RST value is 4.5 kHz

**[[:SOURce]:DM:FSK:FILTer GAUSs, 2.73 | BESSel, 1.22 | BESSel, 2.44 | OFF**

The command activates or deactivates the selected filter. Deactivating the filter is possible at any time. Activating the filter is only possible when values DEVIation and BITRate correspond to the standard values.

Example: :SOUR:DM:FSK:FILT GAUS, 2.73 \*RST value is OFF

**[[:SOURce]:DM:FSK:POLarity NORMal | INVerted**

The command specifies the polarity of the modulation.

NORMal Logic "0" reduces the frequency, logic "1" increases it.

INVerted Logic "1" reduces the frequency, logic "0" increases it.

Example: :SOUR:DM:FSK:POL INV \*RST value is NORMal

**[[:SOURce]:DM:FSK4**

The commands to set the data source for the digital frequency modulation with exactly four states are under this node. In contrast to the other modulations, there are trigger commands for FSK and FSK4 which also permit a single processing of the data list.

**[[:SOURce]:DM:FSK4:STANdard ERMes | APCO| MODacom | FLEX3200 | FLEX6400**

This short -form command sets parameters shown in the table to the values specified by the standards (cf. table). The command is an abbreviation of the commands listed in the table. Hence it neither has a query form nor an \*RST value.

Short command	Command sequence
:DM:FSK4:STANdard ERMes	:DM:FSK4:BRAT 6.25 kb/s :DM:FSK4:FILTer BESSel, 1.25 :DM:FSK4:DEVIation 4.68756kHz
:DM:FSK4:STANdard APCO	:DM:FSK4:BRAT 9.6 kb/s :DM:FSK4:FILTer COS, 0.2 :DM:FSK4:DEVIation 1.800kHz
:DM:FSK4:STANdard MODacom	:DM:FSK4:BRAT 9.6 kb/s :DM:FSK4:FILTer SCOS, 0.2 :DM:FSK4:DEVIation 2.0kHz
:DM:FSK4:STANdard FLEX3200	:DM:FSK4:BRAT 3.2 kb/s :DM:FSK4:FILTer BESSel, 1.22 :DM:FSK4:DEVIation 4.8kHz
:DM:FSK4:STANdard FLEX6400	:DM:FSK4:BRAT 6.4 kb/s :DM:FSK4:FILTer BESSel, 2.44 :DM:FSK4:DEVIation 4.8kHz

Example: :SOUR:DM:FSK4:STAN ERM

**[[:SOURce]:DM:FSK4:BRATe 1 to 24.3 kb/s | 27.0 to 48.6 kb/s**

The command sets the bit rate for the modulation.

Example: :SOUR:DM:FSK4:BRAT 6.25 kb/s \*RST value is 6.25 kb/s



**[[:SOURce]:DM:FSK4:CODing** ERMes | APCO | MODacom | FLEX

The command specifies according to which standard the coding between binary data and generated signal is performed.

Example: :SOUR:DM:FSK4:COD ERM \*RST value is ERMes

**[[:SOURce]:DM:FSK4:DEVIation** 0.01 to 400 kHz

This command sets the frequency deviation of the modulation.

Example: :SOUR:DM:FSK4:DEV 4.6875kHz \*RST value is 4687.5

**[[:SOURce]:DM:FSK4:FILTer** BESSel, 1.22|1.25|2.44 | COS|SCOS, 0.2

This command selects the filter of the modulation.

Example: :SOUR:DM:FSK4:FILT COS, 0.2 \*RST value is BESSel, 1.25

**[[:SOURce]:DM:FSK4:POLarity** NORMal | INVerted

The command specifies the polarity of the modulation.

NORMal A "0" from the data source reduces the frequency, "1" increases it.

INVerted A "1" from the data source reduces the frequency, "0" increases it.

Example: :SOUR:DM:FSK4:POL INV \*RST value is NORMal

**[[:SOURce]:DM:FFSK**

The commands to check the two-stage modulation FFSK are under this node. An LF signal is FSK-modulated and then serves as an input signal for an FM modulation of the actual carrier.

**[[:SOURce]:DM:FFSK:STANdard** POCsag

This short-form command sets parameter shown in the table to the value specified by the standard (cf. table). The command is an abbreviation of the commands listed in the table. Hence it neither has a query form nor an \*RST value.

Short command	Command sequence
:DM:FSK4:STANdard POCsag	:DM:FFSK:DEVIation 4.5 kHz

Example: :SOUR:DM:FFSK:STAN POCs

**[[:SOURce]:DM:FFSK:BRATe** 0.05 to 90 kb/s

This command sets the bit rate of the modulation.

Example: :SOUR:DM:FFSK:BRAT 2400 \*RST value is: 1200 b/s

**[[:SOURce]:DM:FFSK[:DEVIation]** 1.5 kHz | 2.0 kHz | 3.0 kHz | 3.5 kHz | 4.0 kHz | 4.5 kHz

The command sets the frequency deviation of the modulation.

\*RST value is: 4.5 kHz

Example: :SOUR:DM:FFSK:DEV 100kHz

### 3.6.11.4 SOURce:ERMeS Subsystem

This subsystem contains the commands to set the ERMES signal. ERMES uses a 4FSK modulation. The parameters of the DM:FSK4 subsystem, however, are not influenced by settings in the ERMeS subsystem. Switchover between the output of useful or filler subsequences is by means of the TRIGger:DM subsystem.

Command	Parameter	Default Unit	Remark
<b>[:SOURce]</b>			
<b>:ERMeS</b>			Option SME-B11/ SME-B12
<b>:STATe</b>	ON   OFF		
<b>:AUTO</b>	ON   OFF		
<b>:CHANnel</b>	0 to 15		
<b>:ERRor</b>			
<b>:MASK</b>	0 to 1073741823		
<b>:BATCh</b>	A to P		
<b>:WORD</b>	0 to 153 ( 0 to 189 for long batch)		
<b>:MESSage</b>			
<b>:CATegory</b>	TONE   NUMeric   ALPHAnumeric		
<b>:ALPHAnumeric</b>			
<b>:DATA</b>	"String"		
<b>[:SElect]</b>	"FOX" "ALPHA" "LONG" "USER1 to 3"		
<b>:IA   IADdress</b>	0 to 262143		
<b>:NUMeric</b>	"String"		
<b>:TONE</b>	0 to 15		
<b>:NINformation</b>	0 to 7		
<b>:OPERator</b>	0 to 63		
<b>:PA   PARea</b>	0 to 799		
<b>:ZCOuntry</b>			
<b>:SEquence</b>	A to P {,A to P}		
<b>:DBATch</b>			
<b>:SI   SINformation</b>	ON   OFF		
<b>:ETI</b>	ON   OFF		
<b>:BAI</b>	0 to 30		
<b>:FSI</b>	1 to 31		
<b>:DOMonth</b>	00,00 to 23,59		
<b>:TIME</b>	MESSage   STARt   ONCE		
<b>:TACTion</b>			

**[:SOURce]:ERMeS:STATe ON | OFF**

The command switches on the ERMES signal and hence switches off all other active DM modulations. The RF frequency is set to the value determined by command `SOURce:ERMeS:CHANnel`.

If `STATe:AUTO` is ON with every change from OFF to ON, the data for the memory extension are recalculated and written into list "XMEM". Every change of one of the ERMES parameters requires the data to be recalculated, i.e. a brief switchover to `STATe OFF` after every change.

Example: `:SOUR:ERM:STAT ON` \*RST value is OFF

**[[:SOURce]:ERMeS:STATe:AUTO ON | OFF**

The command specifies whether the ERMES data are to be newly calculated on switching from ERMeS:STATe OFF to :STATe ON.

ON The data are newly recalculated and written into list "XMEM"

OFF The existing contents are kept in the memory extension. This can be used to transfer data generated or changed by an external program to the memory extension and thus generate a ERMeS telegram. \*RST value is ON

Example: :SOUR:ERM:STAT:AUTO ON

**[[:SOURce]:ERMeS:CHANnel 0 to 15**

The command determines the channel and thus the transmitter frequency for ERMeS (cf. Chapter 2, Section "Radiocommunication Service ERMES"). This command also influences the structure of the ERMES data. This is why the channel cannot be changed by adjusting the frequency using command SOURce:FREQuency but only using command SOURce:ERMeS:CHANnel and then changing to STATe OFF and then to STATe ON again.

Example: :SOUR:ERM:CHAN 1 \*RST value is 0

**[[:SOURce]:ERMeS:ERRor**

The SME offers the possibility of entering bit errors into a 30-bit word of the message transmitted for test purposes. The commands to specify the bit errors and their position are under this node.

**[[:SOURce]:ERMeS:ERRor:MASK 0 to 1073741823**

The command specifies the faulty bits of the word of the message selected using ERRor:WORD. 30 bits can be defined as faulty (1) or perfect (0). The decimal number transmitted is converted internally into a 30-bit binary number and thus determines the 30 bits. These bits are XORed with the word to be corrupted and hence determine which bits of this word are transmitted correctly or wrongly. \*RST value is 0

Example: :SOUR:ERM:ERR:MASK 5

**[[:SOURce]:ERMeS:ERRor:BATCh A to P**

The command specifies in which of batches A to P the faulty word is. The faulty word is determined by command SOURce:ERMeS:ERRor:WORD. \*RST does not influence this setting.

Example: :SOUR:ERM:ERR:BATC P

**[[:SOURce]:ERMeS:ERRor:WORD 0 to 153 (0 to 189 for long batch)**

The command determines the faulty word in the batch selected by means of command SOURce:ERMeS:ERRor:BATC. \*RST value is 0

Example: :SOUR:ERM:ERR:WORD 111

**[[:SOURce]:ERMeS:MESSAge**

The commands to set the destination address and to determine the message data are under this node.

**[:SOURce]:ERMeS:MESSAge:IA | IADdress 0 to 262143**

The command determines the address ("Initial ADdress") of the pager addressed. Each pager has an own, nonrecurring address. 0 are 262143 are valid values, i.e. all numbers which can be indicated using 18 bits. \*RST value is 0

Example: :SOUR:ERM:MESS:IA 0

**[:SOURce]:ERMeS:MESSAge:CATegory ALPHAnumeric | NUMeric | TONE**

The command specifies the category of the message to be sent.

ALPHAnumeric Alphanumeric message

NUMeric Numeric message

TONETone-only message

Example: :SOUR:ERM:MESS:CAT NUM \*RST value is TONE

**[:SOURce]:ERMeS:MESSAge:ALPHAnumeric**

The commands to specify the contents of the alphanumeric message are under this node. These commands are only effective if `ERMeS:MESSAge:CATegory ALPHAnumeric` is selected.

**[:SOURce]:ERMeS:MESSAge:ALPHAnumeric[:SElect] "FOX" | "ALPHA" | "LONG" | "USER1" | "USER2" | "USER3"**

The command selects the alphanumeric message. The following is available:

"FOX" The quick brown fox jumps over the lazy dog

"ALPHA" ABCD to (complete ERMES character set)

"LONG" Message completely filling a batcht

"USER1to3" Three messages which can be edited freely using command `ALPHAnumeric:DATA`

Example: :SOUR:ERM:MESS:ALPH:SEL FOX \*RST value is USER3

**[:SOURce]:ERMeS:MESSAge:ALPHAnumeric:DATA "String"**

The command permits the input of an arbitrary character string into one of the alphanumeric messages USER1 to 3. This message must be selected before using `ALPHAnumeric:SElect`.

\*RST value is "" (i.e., empty message)

Example: :SOUR:ERM:MESS:ALPH:DATA "Hello"

**[:SOURce]:ERMeS:MESSAge:NUMeric "string"**

The command specifies which character string the numeric message consists of. The SME permits maximally 16 digits. In addition to the 10 digits "0" to "9", the signs forward slash "/", upper-case letter "U", hyphen "-", period ".", percent "%" and blank can be used. This command is only effective if `CATegory NUMeric` has been selected.

Example: :SOUR:ERM:MESS:NUM "12% 15-17" \*RST value is "" (i.e., empty message)

**[SOURce]:ERMeS:MESSAge:TONE** 0 to 15

The command specifies which of the 16 tones possible (8 normal, 8 urgent) are transmitted in a tone-only message. This command is only effective if CATegory TONE has been selected.

Example: :SOUR:ERM:MESS:TONE 7 \*RST value is 0

**[SOURce]:ERMeS:NINFormation**

The commands to set the data denoting the network (the SME simulates) in greater detail are under this node. These data are part of every message sent (cf. ERMES standard).

**[SOURce]:ERMeS:NINFormation:OPERator** 0 to 7

The command sets the code of the network operator. \*RST value is 0

Example: :SOUR:ERM:NINF:OPER 1

**[SOURce]:ERMeS:NINFormation:PA | PAREa** 0 to 63

The command sets the paging area. \*RST value is 0

Example: :SOUR:ERM:NINF:PA 4

**[SOURce]:ERMeS:NINFormation:ZCOuntry** 0 to 799

The command sets the zone and the country code in the message to be sent. Germany has code 262 \*RST value is 262

Example: :SOUR:ERM:NINF:ZCO 799

**[SOURce]:ERMeS:SEQuence**

The commands specifying the structure of the message subsequences are under this node. The control of the subsequence (message or fill subsequences, cf. Chapter 2, Section "Radiocommunication Service ERMES") is effected via the TRIGger system.

**[SOURce]:ERMeS:SEQuence:DBATch** A to P {,A toP}

The command indicates the batches which are to contain message data.

After \*RST value, no batch contains user data

Example: :SOUR:ERM:SEQ:DBAT A, B, C, G, H, M, P

**[SOURce]:ERMeS:SI|SINFormation**

The commands to set the sending system are under this node (cf. ERMES standard). The data are part of every message sent.

**[SOURce]:ERMeS:SI|SINFormation:BAI** ON | OFF

The command sets the Border Area Indicator Bit. \*RST value is OFF

Example: :SOUR:ERM:SI:BAI ON

**[:SOURce]:ERMeS:SI|SINFormation:ETI ON | OFF**

The command sets the External Traffic Indicator Bit.

\*RST value is OFF

Example: :SOUR:ERM:SI:ETI ON

**[:SOURce]:ERMeS:SI|SINFormation:FSI 0 to 30**

The command sets the Frequency Subset Indicator. According to the standard, one-channel networks have an FSI of 30.

\*RST value is 30

Example: :SOUR:ERM:SI:FSI 20

**[:SOURce]:ERMeS:SI|SINFormation:DOMonth 1 to 31**

The command sets the date (day of month).

\*RST value is 1

Example: :SOUR:ERM:SI:DOM 24

**[:SOURce]:ERMeS:SI|SINFormation:TIME 00,00 to 23,59**

The command sets the time.

\*RST value is 00,00

Example: :SOUR:ERM:SI:TIME 12,00

**[:SOURce]:ERMeS:TACTion MESSage | START | ONCE**

This command (Triger ACTION) determines the action which is activated by a trigger event. The valid trigger events are specified by command TRIGger:DM:SOURce. This command also defines the allocation between manual and remote-control operations.

**MESSage** A trigger event switches from filler data output to useful data output for the duration of a subsequence (12 s). The filler data are then output again.

**START** Digital modulation is started by a trigger event. Useful data are then continuously output according to the settings.  
This setting is suitable, for example, for a synchronous start of several units.

**ONCE** The output of the message subsequence is only started by a valid trigger event. After recognition of this signal, exactly one message subsequence (length: 12 seconds) is output. After that, the SME waits for its trigger pulse again (defined under TRIG:DM:SOUR).

Example: :SOUR:ERM:TACT MESS

\*RST value is MESSage

### 3.6.11.5 SOURce:FLEX Subsystem

This subsystem contains the commands for setting the FLEX signal. Like ERMES, FLEX is a radiocommunication service that makes for convenient paging. When equipped with the SME-B41 (FLEX), SME-B11 (DM coder) and SME B12 (DM memory extension) options, the SME generates call signals complying to the FLEX standard. All essential parameters and the message to be transmitted are freely selectable. Switchover between the output of useful or filler signals is by means of the TRIGger:DM subsystem.

Command	Parameter	Default Unit	Remark
[:SOURce]			
:FLEX			Options SME-B11/ SME-B12/SME-B41
:STATe	ON   OFF		
:AUTO	ON   OFF		
:CYCLe	0 to 14		
:DEViation	2.0 to 10.0 kHz	Hz	
:ERRor			
:MASK	0 to 4294967295		
:WORD	0 to 87		
:FCOntent	"X   O   A   space [,X   O   A   space]"		
:AUTO	ON   OFF		
:MODulation	1600, FSK2   3200, FSK2   3200,FSK4   6400,FSK4		
:PHASe	A   B   C   D   AB   AC   AD   BC   BD   CD   ABC   ABD   ACD   BCD   ABCD		
:AUTO	ON   OFF		
:MESSAge			
:CAPCode	"A0 000 001 to 999 999 999"		
:CATegory	ALPHAnumeric   SECure   BINary   NUMeric   SNUMeric   TONE		
:ALPHAnumeric			
[:SElect]	'FOX'   'ALPHA'   'USER1 to 4'		
:CATalog?			
:DATA	"Alphanumeric data"		Query only
:BINary			
[:SElect]	" Name"		
:BLENgtH	1 to 16		
:CATalog?			
:DATA	"0   1 [,0  1]"		Query only
:DDIRection	LEFT   RIGHT		
:MNUMbering	ON   OFF		
:MDRop	ON   OFF		
:NUMeric	" string"		
:REPeats	0 to 3		
:TONE	0 to 7		
:SI   SINformation			
:COLLapse	0 to 7		
:DATE	Year, month, day		
:LCHannel	0 to 511		
:TIME	00,00 to 23,59		
:CZONE	0 to 31		
:TACTion	MESSAge   STARt   ONCE		

**[[:SOURCE]:FLEX:STATE ON | OFF**

The command switches the FLEX signal on; all other activated DM modulations are switched off. In contrast to ERMES, the RF frequency is not changed.

Every switchover from OFF to ON results in a recalculation of the memory extension data and their entry into the list "XMEM" if :FLEX:STATE:AUTO is set to ON. Every change of a FLEX parameter except for :FLEX:FCONTENT requires a recalculation of data, ie after every parameter change, STATE OFF has to be briefly activated.

Example: :SOUR:FLEX:STAT ON

\*RST value is OFF

**[[:SOURCE]:FLEX:STATE:AUTO ON | OFF**

The command determines whether the FLEX data have to be recalculated after switchover from FLEX:STATE OFF to STATE ON.

ON The data are recalculated and entered into the memory extension.

OFF The previous memory extension contents are not cleared. This feature can be used for data generated or altered by an external program and then transmitted into the memory extension to generate a FLEX telegram.

\*RST value is ON

Example: :SOUR:FLEX:STAT:AUTO ON

**[[:SOURCE]:FLEX:CYCLE 0 to 14**

The command determines which number is assigned to the first cycle after switch on of FLEX. Frame numbering always starts with 0.

Example: :SOUR:FLEX:CYCL 0

\*RST value is 0

**[[:SOURCE]:FLEX:DEVIATION 2.0 to 10.0 kHz**

The command determines the frequency deviation of the modulation. The deviation specifies the spacing from the carrier for the two far-placed symbols in 4FSK. The FLEX standard specifies 4800 Hz for this value which may be varied for testing.

Example: :SOUR:FLEX:DEV 4.8kHz

\*RST value is 4800 Hz

**[[:SOURCE]:FLEX:ERROR:MASK 0 to 4294967295**

The command determines the erroneous bits in a 32-bit field. The transmitted decimal number (0...4294967295) is converted internally into a 32-bit binary number and thus defines the 32 bits. These bits are XORed with the word of the message which is to be falsified and thus determine which bits of this word are to be transmitted correctly or incorrectly.

**Note:** XORing precedes block interleaving (see flex standard)! It is carried out in all phases of all message frames (i.e., the 'X' marked frames under FRAME CONTENTS).

Example: :SOUR:FLEX:ERROR:MASK 0

\*RST value is 0.



**[[:SOURCE]:FLEX:ERROR:WORD 0 to 87**

This command determines the position of the word to be falsified. The words are numbered from block 0, word 0 to block 10, word 7 of a frame. The sync part and the frame information word cannot be falsified. The falsification precedes block interleaving in all transmitted phases.

Example: :SOUR:FLEX:ERROR:WORD 0 \*RST value is 0.

**[[:SOURCE]:FLEX:FCONTENT "X | blank spaces | O | A [,X] blank spaces | O | A]"**

This command determines the contents of the 128 frames. Each frame is represented by a character. If less than 128 values are indicated, the output cycle is shortened correspondingly.

X Flex useful data

SpaceFlex filler data

O Simulated data of another radiocommunication service (O for OTHER)

A "Emergency Resynchronization" specified in the FLEX standard (A stands for ASYNC)

The frame assigned to the pager is calculated from the value of FLEX:MESSAGE:CAPCODE according to the following formula:

Frame = (Integer(CAPCODE/16)) modulo 128

- Notes:**
- The SINformation:COLLapse value may cause the pager to respond to much more than merely its "own" frame.
  - As the FLEX signal generation is subject to the trigger system, the settings under TRIGger:DM, determine whether the specified frame contents or only the filler frames are output.

Example: :SOUR:FLEX:FCON "X, , ,O,O,O,O,O,X,X,X,A,A,A, ,X"

**[[:SOURCE]:FLEX:FCONTENT:AUTO ON | OFF**

This command determines the influence of changes of CAPCODE on FRAME CONTENT.

ON FRAME CONTENT is set so that in all frames evaluated by the receiver (and only in those) FLEX data are also transmitted. All the other frames only contain filler data.

OFF A change of CAPCODE has no influence on FRAME CONTENT.

Example: :SOUR:FLEX:FCON:AUTO ON \*RST value is ON

**[[:SOURCE]:FLEX:MODulation 1600, FSK2 | 3200, FSK2 | 3200,FSK4 | 6400,FSK4**

The command determines the used bit rate and modulation. FLEX recognizes four modulations:

1600bps/2FSK                      3200bps/2FSK                      3200bps/4FSK                      6400bps/4FSK

Example: :SOUR:FLEX:MOD 1600,FSK2 \*RST value is 1600,2FSK



**[[:SOURCE]:FLEX:MESSAGE:ALPHANumeric[:SELEct]** "FOX" | "ALPHA" | "USER1" | "USER2" |  
"USER3" | "USER4"

This node contains commands for the determination of the contents of the alphanumeric and the secured messages. There is one common character set for the two types of messages. These commands can only be activated if `FLEX:MESSAGE:CATegory` `ALPHAnumeric` or `SECure` is selected.:

"FOX"           The quick brown fox jumps over the lazy dog

"ALPHA"         ABCD to (complete FLEX character set)

"USER1 to 4"    Four messages that can be freely edited by command `ALPHAnumeric:DATA`.

Example:         : SOUR:FLEX:MESS:ALPH:SEL "FOX"                                 \*RST value is USER3

**[[:SOURCE]:FLEX:MESSAGE:ALPHANumeric:CATalog?**

The command queries the alphanumeric and secured alphanumeric messages available. It causes a list to be returned on which the entries are separated by commas. The command is a query command and thus has no \*RST value.

Example:         : SOUR:FLEX:MESS:ALPH:CAT?   Answer: FOX, ALPHA, USER1

**[[:SOURCE]:FLEX:MESSAGE:ALPHANumeric:DATA** "String"

The command allows any character string to be entered into one of the alphanumeric messages USER 1 to 4. This message has to be selected first with the command `ALPHAnumeric:SELEct`.

\*RST value is "" (eg, empty message)

Example:         : SOUR:FLEX:MESS:ALPH:DATA "Hallo"

**[[:SOURCE]:FLEX:MESSAGE:BINary**

This node contains commands for the determination of the contents of the binary messages. The commands can only be activated if `FLEX:MESSAGE:CATegory` `BINary` is selected.

**[[:SOURCE]:FLEX:MESSAGE:BINary[:SELEct]** "USER1" | "USER2"

The command selects the binary messages.

\*RST value is USER1

Example:         : SOUR:FLEX:MESS:BIN:SEL "USER1"

**[[:SOURCE]:FLEX:MESSAGE:BINary:BLENght** 1 to 16

The command sets the number of bits to be interpreted as a unit (character). This value has no significance for SME. It is transmitted to the pager and evaluated there.         \*RST value is 1

Example:         : SOUR:FLEX:MESS:BIN:BLEN 16

**[[:SOURCE]:FLEX:MESSAGE:BINary:CATalog?**

The command queries the binary messages available. It causes a list to be returned on which the entries are separated by commas. The command is a query command and thus has no \*RST value.

Example:         : SOUR:FLEX:MESS:BIN:CAT?   Answer: USER1

**[[:SOURCE]:FLEX:MESSAGE:BINary:DATA** "0 | 1 [,0 | 1]"

The command allows the entry of any binary data into one of the binary messages. Values 0 and 1 are available. Each value represents 1 bit. The maximum length of the message is 460 bit. This message has to be selected first with the command `BINary:SELEct`.

Example:         : SOUR:FLEX:MESS:BIN:DATA "111101"   \*RST value is "" (i.e., empty message)

**[:SOURce]:FLEX:MESSAge:BINary:DDIRection** LEFT | RIGHT

The command determines the direction of binary messages.

LEFT Display from left to right.

RIGHT Display from right to left.

\*RST value is LEFT

Example: :SOUR:FLEX:MESS:BIN:TYPE LEFT

**[:SOURce]:FLEX:MESSAge:MNUMbering** ON | OFF

The command determines whether every message is to be assigned with a number and whether this information is to be evaluated when received by the pager.

ON SME sends the number 0 for every message.

OFF No number is sent.

\*RST value is OFF

Example: :SOUR:FLEX:MESS:MNUM OFF

**[:SOURce]:FLEX:MESSAge:MDRop** ON | OFF

The command determines whether or not the messages are to be marked with a MAIL-DROP flag (see chapter 2, section "Radiocommunication Service FLEX").

ON The messages are marked as "volatile".

OFF The messages are not marked.

\*RST value is OFF

Example: :SOUR:FLEX:MESS:MDR OFF

**[:SOURce]:FLEX:MESSAge:NUMeric** "String"

The command determines the type of character string the numeric message may consist of. SME allows a maximum of 41 characters. In addition to the 10 figures "0" to "9" other characters such as square brackets right and left "[", "]", upper case letter "U", hyphen "-" and blank space " " can be used. This command can only be activated if FLEX:MESSAge:CATegory NUMeric is selected.

\*RST value is "0123456789 U-[]"

Example: :SOUR:FLEX:MESS:NUM "15-17"

**[:SOURce]:FLEX:MESSAge:REPeats** 0 to 3

The command determines the number of calls following the first call according to FLEX-TD. For the value 0 (no repeat), normal flex frames are transmitted, whereas subframes according to FLEX-TD are used with other values (cf. Section 2.6.3.12, Radiocommunication Service FLEX).

Example: :SOUR:FLEX:MESS:REP 0

\*RST value is 0

**[:SOURce]:FLEX:MESSAge:TONE** 0 to 7

The command determines which of the 8 possible tones is to be transmitted in case of an only-tone message. This command can only be activated if FLEX:MESSAge:CATegory TONE is selected.

Example: :SOUR:FLEX:MESS:TONE 7

\*RST value is 0

**[[:SOURCE]:FLEX:SI|SINFORMATION**

This node contains commands used to set the data of the transmitting system (see FLEX standard). These data are sent to the pager. CZONE, DATE, and TIME are transmitted every hour in cycle 0, frame 0.

**[[:SOURCE]:FLEX:SI|SINFORMATION:COLLAPSE 0 to 7**

The command indicates the number of bits (0 to 7) the pager uses to compare its "built-in" frame number with the received frame number. The value 7 signifies that the pager only accepts messages in one of the 128 frames (provided that its pager collapse value is not below 7). With the value 0 the pager receives messages in any frame. \*RST value is 4

Example: :SOUR:FLEX:SI:COLL 4

**[[:SOURCE]:FLEX:SI | SINFORMATION:ROAMING OFF | SSID | NID | ALL**

The command indicates Activating/Deactivating generation of roaming information in the telegram sent.

OFF None; the roaming bits in the frame information word have the value 0.

SSID BIW000 for all frames, each in one phase.

BIW111 in the first four frames, each in one phase.

NID NID in all frames which comply with the formula specified in the FLEX standard. The cycle value is however fixed to the value of START IN CYCLE; consists of a network address and a short message vector; no BIW and no message body is generated.

ALL All the information of NID and SSID together.

If ROAMING is not set to OFF, the following additional information is included in the telegram:

- TIME INFO (a BIW010 in phases 0 and 2 of frame 0 and a BIW001 in phases 1 and 3 of frame 0. As the SME is not able to differentiate between cycles, the contents of the phases does not rotate over both BIWs; moreover, *no* BIW001 is sent for 1600 bps because only one phase is present).
- CHANNEL SETUP INSTRUCTION (in one phase in each of the first four frames; for 1600 bps not in the first frame as there is no space; consists of a BIW101; has no address, no vector and no message body).
- SYSTEM EVENT NOTIFICATION (starting from frame 0 for a collapse cycle, i.e.  $2^{sc}$ , where *sc* denotes the value set under SYSTEM COLLAPSE VALUE; consists of an operator message address and a short instruction vector, has no message body and no BIW101).
- MESSAGE FOR ALL SUBSCRIBERS (is generated depending on the contents of FRAME CONTENTS, also if ROAMING is set to OFF; consists of an operator message address, a vector and a message body, has no BIW101).

IEC-bus command: :SOUR:FLEX:SINF:ROAM OFF

**[[:SOURCE]:FLEX:SI|SINFORMATION:MULTIPLIER 1 to 7**

The command sets the input value of the multiplier part of the network ID.

IEC-bus command: :SOUR:FLEX:SINF:MULT 1 \*RST value is 1

**[[:SOURCE]:FLEX:SI|SINFORMATION: COUNTRY 0 to 999**

Input value of the country code.

IEC-bus command: :SOUR:FLEX:SINF:COUN 0 \*RST value is 0

**[:SOURce]:FLEX:SI|SINFormation: CZONE 0 to 31**

This command determines the coverage zone. \*RST value is 0

Example: `:SOUR:FLEX:SI:CZON 0`

**[:SOURce]:FLEX:SI|SINFormation: STMF 0 to 31**

The command allows the entry of any input value of the four traffic management flags for SSID.

IEC-bus command: `:SOUR:FLEX:SINF:STMF 15` \*RST value is 15

**[:SOURce]:FLEX:SI|SINFormation: DATE Year, month, day**

The command sets the date. \*RST value is 1994,01,01

Example: `:SOUR:FLEX:SI:DATE 1994,01,01`

**[:SOURce]:FLEX:SI|SINFormation: FOFFset 0 to 63**

The command sets the input value of the frame offsets.

IEC-bus command: `:SOUR:FLEX:SINF:FOFFset 0` \*RST value is 0

**[:SOURce]:FLEX:SI|SINFormation: LID 0 to 511**

The command sets the input value of the local ID.

IEC-bus command: `:SOUR:FLEX:SINF:LID 0` \*RST value is 0

**[:SOURce]:FLEX:SI|SINFormation: NADDress 2058240 to 20622335**

Input value of the network address part of the network ID.

IEC-bus command: `:SOUR:FLEX:SINF:NADD 2058240` \*RST value is 2058241

**[:SOURce]:FLEX:SI|SINFormation: NTMFlags 0 to 15**

The command sets the input value of the four traffic management fags for NID

IEC-bus command: `:SOUR:FLEX:SINF:NTMF 15` \*RST value is 0

**[:SOURce]:FLEX:SI|SINFormation: SAREa 0 to 31**

The command sets the input value of the service area part of the network ID.

IEC-bus command: `:SOUR:FLEX:SINF:SAR 0` \*RST value is 15

**[:SOURce]:FLEX:SI|SINFormation: TIME 00,00 to 23,59**

This command sets the time. \*RST value is 12,00

Example: `:SOUR:FLEX:SI:TIME 12,00`

**[:SOURce]:FLEX:TACTion MESSAge | START | ONCE**

This command (Triger ACTion) determines the action which is activated by a trigger event. The valid trigger events are specified by command `TRIGger:DM:SOURce`. This command also defines the allocation between manual and remote-control operations.

**MESSAge** A trigger event switches from filler data output to useful data output for the duration of a batch (1.875 s). The filler data are then output again.

**START** Digital modulation is started by a trigger event. Useful data are then continuously output according to the settings. This setting is suitable, for example, for a synchronous start of several units.

**ONCE** The output of the FLEX telegram is only started by a valid trigger event. After recognition of this signal, exactly one frame is output in the way it has been set under `:FLEX:FCONT`. After that, the SME waits for its trigger pulse again (defined under `TRIG:DM:SOUR`).

Example: `:SOUR:FLEX:TACT MESS` \*RST value is MESSAge

### 3.6.11.6 SOURce:FM Subsystem

This subsystem contains the commands to check the frequency modulation and to set the parameters of the modulation signal. The SME can be equipped with two independent frequency modulators (option SM-B5). They are differentiated by a suffix after FM.

SOURce:FM1

SOURce:FM2

Command	Parameter	Default Unit	Remark
[:SOURce] :FM1 2 [:DEVIation] :EXTernal1 2 :COUPling :INTernal :FREQUency :PREEmphasis :SOURce :STATe	0 to 1MHz,; AC   DC 400 Hz   1 kHz   3 kHz   15 kHz 0.1 Hz to 500 kHz or 0.1 Hz to 1 MHz 0   50us   75us INT   EXT1   EXT2 ON   OFF	Hz    Hz	Option SM-B5 SME03/03E: 0 to 2MHz SME06: 0 to 4MHz   Option SM-B2 or -B6

**[:SOURce]:FM1|2[:DEVIation]** 0 to 1 MHz; SME03/03E: 0 to 2 MHz; SME06: 0 to 4 MHz

The command specifies the frequency variation caused by the FM. Although the LF generators are used as modulation sources, the frequency variation is independent of the voltage at the LF output. The maximally possible DEVIation depends on SOURce:FREQUency (cf. data sheet).

Example: :SOUR:FM1:DEV 5kHz

\*RST value is 10 kHz

#### [:SOURce]:FM1|2:EXTernal 2

The commands to set the external FM input are under this node. The settings under EXTernal for modulations AM, FM and PM are independent of each other. The settings are always related to the socket which is determined by the numeric suffix after EXTernal. The suffix after FM is ignored then. With the following commands, e.g., the settings are both related to EXT2 input:

:SOUR:FM1:EXT2:COUP AC

:SOUR:FM2:EXT2:COUP AC

A command without suffix is interpreted like a command with suffix 1.

#### [:SOURce]:FM1|2:EXTernal1|2:COUPling AC | DC

The command selects the type of coupling for the external FM input.

AC The d.c. voltage content is separated from the modulation signal.

DC The modulation signal is not altered.

\*RST value is AC

Example: :SOUR:FM:EXT:COUP AC

**[[:SOURce]:FM1|2:INTernal**

The settings for the internal FM generators are effected under this node. For FM1, this is always LF generator 1, for FM2, always LF generator 2. Here the same hardware is set for FM1, PM1, AM:INT1 as well as SOURce0, just like for FM2, PM2 and AM:INT2 as well as SOURce2. This means that, e.g., the following commands are coupled with each other and have the same effect:

```
SOUR:AM:INT2:FREQ
SOUR:FM2:INT:FREQ
SOUR:PM2:INT:FREQ
SOUR2:FREQ:CW
```

**[[:SOURce]:FM1|2:INTernal:FREQuency** 400 Hz | 1 kHz | 3 kHz | 15 kHz or 0.1 Hz to 500 kHz or 0.1 Hz to 1 MHz

The command sets the modulation frequency. There are different specified ranges depending on the equipment of the instrument:

If neither SM-B2 nor SM-B6 are fitted, only FM 1 is permissible and values 400 Hz, 1 kHz, 3 kHz and 15 kHz are valid. With option SM-B2, the specified range from 0.1 Hz to 500 kHz is valid, with SM-B6, from 0.1 Hz to 1 MHz. \*RST value is 1 kHz

Example: :SOUR:FM:INT:FREQ 10kHz

**[[:SOURce]:FM1|2:PREemphasis** 0 | 50us | 75us

The command selects the preemphasis.

0	No preemphasis	
50 us	50 µs, European standard	
75 us	75 µs, American standard	*RST value is 0

Example: :SOUR:FM:PRE 50us

**[[:SOURce]:FM1|2:SOURce** INTernal | EXTernal1 | EXTernal2

The command selects the modulation source. A command without suffix is interpreted like a command with suffix 1. LF generator 1 is INT for FM1, LF generator2 for FM2 (option SM-B5). Several modulation sources can be active at the same time (cf. example)

\*RST value for FM1: INT

Example: :SOUR:FM:SOUR INT1, EXT2 for FM2:EXT2

**[[:SOURce]:FM1|2:STATe** ON | OFF

The command switches the frequency modulation on or off. \*RST value is OFF.

Example: :SOUR:FM:STAT OFF



### 3.6.11.7 SOURce:FREQUENCY Subsystem

This subsystem contains the commands for the frequency settings of the RF source including the sweeps.

Command	Parameter	Default Unit	Remark
<b>[:SOURce]</b>			
<b>:FREQUency</b>			<b>SME03E/03/06:</b>
<b>:CENTer</b>	5 kHz to 1.5 GHz	Hz	5 kHz to 2.2/3/6 GHz
<b>[:CW]:FIXed]</b>	5 kHz to 1.5 GHz	Hz	5 kHz to 2.2/3/6 GHz
<b>:RCL</b>	INCLude   EXCLude		
<b>:MANual</b>	5 kHz to 1.5 GHz	Hz	5 kHz to 2.2/3/6 GHz
<b>:MODE</b>	CW   FIXed   SWEEp   LIST		
<b>:OFFSet</b>	-50 to +50 GHz	Hz	
<b>:SPAN</b>	0 to 1.5 GHz	Hz	0 to 2.2/3/6 GHz
<b>:STARt</b>	5 kHz to 1.5 GHz	Hz	5 kHz to 2.2/3/6 GHz
<b>:STOP</b>	5 kHz to 1.5 GHz	Hz	5 kHz to 2.2/3/6 GHz
<b>:STEP</b>		Hz	
<b>[:INCRement]</b>	0 to 1 GHz		

**[:SOURce]:FREQUency:CENTer** 5 kHz to 1.5 GHz (SME03E/03/06: 5 kHz to 2.2/3/6 GHz)

The command sets the sweep range by means of the center frequency. This command is coupled to commands `:SOURce:FREQUency:STARt` and `:SOURce:FREQUency:STOP`.

In this command, value `OFFSet` is considered as with input value `FREQUency` in the `FREQUency` menu. Thus the specified range indicated is only valid for `OFFSet = 0`. The specified range with other `OFFSet` values can be calculated according to the following formula (cf. Chapter 2, Section "Frequency Offset" as well):

$$5 \text{ kHz} + \text{OFFSet} \text{ to } 1.5 \text{ GHz} + \text{OFFSet} \quad \text{*RST value is } (\text{STARt} + \text{STOP})/2$$

Example: `:SOUR:FREQ:CENT 100kHz`

**[:SOURce]:FREQUency[:CW]:FIXed]** 5 kHz to 1.5 GHz (SME03E/03/06: 5 kHz to 2.2/3/6 GHz)

The command sets the frequency for CW operation. This value is coupled to the current sweep frequency. In addition to a numeric value, `UP` and `DOWN` can be indicated. The frequency is increased or reduced by the value set under `:SOURce:FREQUency:STEP`. (As to specified range, cf. `FREQUency:CENTer`).

Example: `:SOUR:FREQ:CW 100kHz` \*RST value is 100 MHz

**[:SOURce]:FREQUency[:CW]:FIXed]:RCL** INCLude | EXCLude

The command determines the effect of the recall function on the frequency. \*RST value has no effect to this setting.

**INCLude** The saved frequency is loaded when instrument settings are loaded with the `[RECALL]` key or with a memory sequence.

**EXCLude** The RF frequency is not loaded when instrument settings are loaded, the current settings are maintained.

Example: `:SOUR:FREQ:RCL INCL`

**[:SOURce]:FREQUENCY:MANual** 5 kHz to 1.5 GHz (SME03E/03/06: 5 kHz to 2.2/3/6 GHz)

The command sets the frequency if `SOURce:SWEep:MODE MANual` and `SOURce:FREQUENCY:MODE SWEep` are set. Only frequency values between the settings with `:SOURce:FREQUENCY:START` and `:SOURce:FREQUENCY:STOP` are permitted. (As to specified range, cf. `FREQUENCY:CENTer`) \*RST value is 100 MHz

Example: `:SOUR:FREQ:MAN 500MHz`

**[:SOURce]:FREQUENCY:MODE** CW | FIXed | SWEep | LIST

The command specifies the operating mode and hence also specifies which commands check the FREQUENCY subsystem. The following allocations are valid

**CW | FIXed** CW and FIXed are synonyms. The output frequency is specified by means of `:SOURce:FREQUENCY:CW | FIXed`.

**SWEep** The instrument operates in the SWEep operating mode. The frequency is specified by means of commands `SOURce:FREQUENCY:START; STOP; CENTer; SPAN; MANual`.

**LIST** The instrument processes a list of frequency and level settings. The settings are effected in the `SOURce:LIST` subsystem. Setting `SOURce:FREQUENCY:MODE LIST` automatically sets command `SOURce:POWER:MODE` to LIST as well.

Example: `:SOUR:FREQ:MODE LIST` \*RST value is CW.

**[:SOURce]:FREQUENCY:OFFSet** -50 to + 50 GHz

The command sets the frequency offset of an instrument which might be series-connected, e.g. a mixer. (cf. Chapter 2, Section "Frequency Offset"). If a frequency offset is entered, the frequency entered using `SOURce:FREQUENCY:to` does no longer correspond to the RF output frequency. The following connection is true:

$$\text{SOURce:FREQUENCY:to} = \text{RF output frequency} + \text{SOURce:FREQUENCY:OFFSet}.$$

Entering an offset does not alter the RF output frequency but the query value of `SOURce:FREQUENCY:..`

Example: `:SOUR:FREQ:OFFS 100MHz` \*RST value is 0

**[:SOURce]:FREQUENCY:SPAN** 0 to 1.5 GHz (SME03E/03/06: 5 kHz to 2.2/3/6 GHz)

This command indicates the frequency range for the sweep. This parameter is coupled to the start and stop frequency. Negative values for SPAN are permitted, then `START > STOP` is true. There is the following connection:

$$\text{START} = \text{CENTer} - \text{SPAN}/2$$

$$\text{STOP} = \text{CENTer} + \text{SPAN}/2 \quad \text{*RST value is (STOP - START)}$$

Example: `:SOUR:FREQ:SPAN 1GHz`

**[:SOURce]:FREQUENCY:START** 5 kHz to 1.5 GHz (SME03E/03/06: 5 kHz to 2.2/3/6 GHz)

This command indicates the starting value of the frequency for the sweep operation. Parameters `START`, `STOP`, `SPAN` and `CENTer` are coupled to each other. `START` may be larger than `STOP`. (As to specified range, cf. `FREQUENCY:CENTer`). \*RST value is 100MHz

Example: `:SOUR:FREQ:STAR 1MHz`

**[[:SOURce]:FREQuency:STOP** 5 kHz to 1.5 GHz (SME03E/03/06: 5 kHz to 2.2/3/6 GHz)

This command indicates the final value of the frequency for the sweep operation (see START as well). (As to specified range, cf. FREQuency:CENTer). \*RST value is 500MHz

Example: :SOUR:FREQ:STOP 100MHz

**[[:SOURce]:FREQuency:STEP**

The command to enter the step width for the frequency setting if frequency values UP or DOWN are used is under this node. This command is coupled to the KNOB STEP command in manual control. Only linear step widths can be set.

**[[:SOURce]:FREQuency:STEP[:INCRement]** 0 to 1 GHz

The command sets the step width for the frequency setting.

Example: :SOUR:FREQ:STEP:INCR 1MHz

\*RST value is 1MHz

### 3.6.11.8 SOURce:ILS Subsystem

This subsystem contains the commands to control the characteristics of the test signals for ILS (Instrument Landing System) (option SM-B6, multifunction generator).

Command	Parameter	Default Unit	Remark
[:SOURce]			
:ILS			Option SM-B6
:STATe	ON   OFF		
:SOURce	INT2   INT2, EXT		
:TYPE	GS   GSLOpe   LOCalizer		
[:GS   GSLOpe]			
:MODE	NORM   ULOBe   LLOBe		
:COMid			
[:STATe]	ON   OFF		
:FREQuency	0.1 to 20 000 Hz	Hz	
:DEPTH	0 to 100 PCT	PCT	
:DDM			
:CURRent	-685 uA to+685uA	A	
[:DEPTH]	-0.8 to +0.8		
:DIRection	UP   DOWN		
:LOGarithmic	-999.9 to +999.9		
:LLOBe			
[:FREQuency]	100 to 200 Hz	Hz	
:ULOBe			
[:FREQuency]	60 to 120 Hz	Hz	
:PHASe	0 to 120 deg	rad	
:PRESet	0 to 100 PCT	PCT	No query
:SODePTH			
:LOCalizer			
:MODE	NORM   LLOBe   RLOBe		
:COMid			
[:STATe]	ON   OFF		
:FREQuency	0.1 to 20 000 Hz	Hz	
:DEPTH	0 to 100 PCT	PCT	
:DDM			
:CURRent	-387 to +387 uA	A	
[:DEPTH]	-0.4 to +0.4		
:DIRection	LEFT   RIGHT		
:LOGarithmic	-999.9 to +999.9		
:LLOBe			
[:FREQuency]	60 to 120 Hz	Hz	
:RLOBe			
[:FREQuency]	100 to 200 Hz	Hz	
:PHASe	0 to 120 deg	rad	
:PRESet	0 to 100 PCT	PCT	No query
:SODePTH			

**[[:SOURce]:ILS:STATe ON | OFF**

The command switches the generation of ILS signals on or off. STATe ON is only possible if no amplitude modulation is switched on. Modulation generator 2 must not be switched simultaneously as a source for PM or FM either.

Example: :SOUR:ILS:STAT ON

\*RST value is OFF

**[[:SOURce]:ILS:SOURce INT2 | INT2, EXT**

This command determines the signal sources of the test signal.

INT2 The test signal used for ILS is generated internally by LF generator 2.

INT2 , EXT A signal from input EXT1 is added to the internal signal in addition. Switching off the internal source is not possible.

Example: :SOUR:ILS:SOUR INT2

\*RST value is INT2

**[[:SOURce]:ILS:TYPE GS|GSLope | LOCalizer**

The command switches over between the two components of the ILS method. The configuration of the signals is effected under the respective node GSLope or LOCalizer.

GD|GSLope Vertical component (Glide Slope)

LOCalizer Horizontal component (Localizer)

Example: :SOUR:ILS:TYPE GS

\*RST value is GS

**[[:SOURce]:ILS[:GS|GSLope]**

The commands to specify the characteristics of the glide slope signal are under this node. Whether this signal is output, however, is determined by command SOURce:ILS:TYPE.

**[[:SOURce]:ILS[:GS|GSLope]:MODE NORM | ULOBe | LLOBe**

The command specifies the type of the ILS-GS signal generated.

NORM ILS-GS signal

ULOBe (Upper LOBe) Amplitude modulation of the output signal using the SOURce:ILS:GS:ULOBe:FREQuency signal component (generally 90 Hz) of the ILS-GS signal.

The modulation depth for SOURce:ILS:GS:DDM :DIR DOWN results from  
 $AM(90Hz) = 0.5 * (ILS:GS:SODepth + ILS:GS:DDM * 100\%)$   
 and for SOURce:ILS:GS:DDM:DIR UP from

$AM(90Hz) = 0.5 * (ILS:GS:SODepth - ILS:GS:DDM * 100\%)$

LLOBe (Lower LOBe) Amplitude modulation of the output signal using the SOURce:ILS:GS:LLOBe:FREQuency signal component (generally 150 Hz) of the ILS-GS signal. The modulation depth for SOURce:ILS:GS:DDM :DIR DOWN results from

$AM(150Hz) = 0.5 * (ILS:GS:SODepth + ILS:GS:DDM * 100\%)$

and for SOURce:ILS:GS:DDM:DIR UP from

$AM(150Hz) = 0.5 * (ILS:GS:SODepth - ILS:GS:DDM * 100\%)$

Example: :SOUR:ILS:GS:MODE ULOB

\*RST value is NORM

**[[:SOURce]:ILS[:GS|GSLope]:COMid**

The commands to set the ComId content (communication/identification signal) of the ILS-GS signal are under this node.

**[[:SOURCE]:ILS[:GS|GSLope]:COMid[:STATe] ON | OFF**

The command activates or deactivates the ComId signal.

\*RST value is OFF

Example: :SOUR:ILS:GS:COM:STAT ON

**[[:SOURCE]:ILS[:GS|GSLope]:COMid:FREQuency 0.1 to 20 000 Hz**

The command sets the frequency of the ComId signal.

\*RST value is 1020 Hz

Example: :SOUR:ILS:GS:COM:FREQ 1020

**[[:SOURCE]:ILS[:GS|GSLope]:COMid:DEPTH 0 to 100 PCT**

The command sets the AM modulation depth of the ComId signal.

\*RST value is 10 PCT

Example: :SOUR:ILS:GS:COM:DEPT 10 PCT

**[[:SOURCE]:ILS[:GS|GSLope]:DDM**

(Difference in Depth of Modulation) The commands to set the modulation depth difference between the signal of the upper lobe (90 Hz) and the lower lobe (150 Hz) are under this node. )

**[[:SOURCE]:ILS[:GS|GSLope]:DDM:CURRent - 685 uA to + 685 uA**

The command enters the DDM value alternatively as a current by means of the ILS indicating instrument. This parameter is coupled with SOURCE:ILS:GS:DDM:DEPTH and :LOGarithmic.

Example: :SOUR:ILS:GS:DDM:CURR 0

\*RST value is 0 A

**[[:SOURCE]:ILS[:GS|GSLope]:DDM[:DEPTH] - 0.8 to + 0.8**

The command sets the difference of the modulation depth. This parameter is coupled with SOURCE:ILS:GS:DDM:CURRent.

The following is true for SOURCE:ILS:GS:DDM:DIRection DOWN

$$ILS:GS:DDM:DEPTH = (AM(90Hz) - AM(150Hz))/100\%$$

and for SOURCE:ILS:GS:DDM:DIRection UP

$$ILS:GS:DDM:DEPTH = (AM(150Hz) - AM(90Hz))/100\%$$

Example: :SOUR:ILS:GS:DDM:DEPT 0

\*RST value is 0

**[[:SOURCE]:ILS[:GS|GSLope]:DDM:DIRection UP | DOWN**

The command indicates the direction in which the pilot has to correct the course. By calculation, this setting has the same effect as a reverse of the sign of the SOURCE:ILS:GS:DDM:DEPTH-value.

UP The airplane is too low, it must climb.

DOWN The airplane is too high, it must descend.

Example: :SOUR:ILS:GS:DDM:DIR DOWN

\*RST value is UP

**[[:SOURCE]:ILS[:GS|GSLope]:DDM:LOGarithmic - 999.9 dB to + 999.9 dB**

The command enters the DDM value in dB. This parameter is coupled with SOURCE:ILS:GS:DDM:DEPTH and :CURRent.

\*RST value is 0.0 dB

Example: :SOUR:ILS:GS:DDM:LOG 0

**[[:SOURce]:ILS[:GS|GSLOpe]:LLOBe]**

The commands to configure the signal of the lower ILS-GS antenna lobe are under this node (Lower LOBe).

**[[:SOURce]:ILS[:GS|GSLOpe]:LLOBe[:FREQUENCY]** 100 to 200 Hz

The command sets the frequency. Normally, it is 150 Hz. This parameter is coupled with `SOURce:ILS:GS:ULOBe:FREQUENCY`. As the ratio of `ULOBe:FREQUENCY` and `LLOBe:FREQUENCY` must always be 3/5, `ULOBe:FREQUENCY` is readjusted accordingly.

Example: `:SOUR:ILS:GS:LLOB:FREQ 150` \*RST value is 150 Hz

**[[:SOURce]:ILS[:GS|GSLOpe]:ULOBe]**

The commands to configure the signal of the upper ILS-GS antenna lobe (Upper LOBe) are under this node.

**[[:SOURce]:ILS[:GS|GSLOpe]:ULOBe[:FREQUENCY]** 60 to 120 Hz

The command sets the frequency. Normally, it is 90 Hz. This parameter is coupled with `SOURce:ILS:GS:LLOBe:FREQUENCY`. As the ratio of `ULOBe:FREQUENCY` and `LLOBe:FREQUENCY` must always be 3/5, `LLOBe:FREQUENCY` is readjusted accordingly.

Example: `:SOUR:ILS:GS:ULOB:FREQ 90` \*RST value is 90 Hz

**[[:SOURce]:ILS[:GS|GSLOpe]:PHASe]** 0 to 120 deg

The command sets the phase between the modulation signals of the upper and the lower antenna lobe. The zero crossing of the signal of the lower lobe serves as a reference. The angle is related to the period of the signal of the lower antenna lobe. \*RST value is 0

Example: `:SOUR:ILS:GS:PHAS 0deg`

**[[:SOURce]:ILS[:GS|GSLOpe]:SODePTH]** 0 to 100 PCT

The command indicates the sum of the modulation depths of the signals of the lower lobe (90 Hz) and the upper lobe (150 Hz). \*RST value is 80PCT

Example: `:SOUR:ILS:GS:SOB 80PCT`

**[[:SOURce]:ILS[:GS|GSLOpe]:PRESet]**

This command is equivalent to the following GS defaultcommand sequence:

```
:ILS:STAT ON
:ILS:TYPE GS
:ILS:SOUR INT2
:ILS:GS:MODE NORM
:ILS:GS:COM OFF
:ILS:GS:COM:FREQ 1020Hz
:ILS:GS:COM:DEPT 10PCT
:ILS:GS:DDM 0.0
:ILS:GS:DDM:DIR UP
:ILS:GS:SOD 80PCT
:ILS:GS:ULOB 90Hz
:ILS:GS:LLOB 150Hz
:ILS:GS:PHAS 0
```

The values set correspond to the state after `SYSTem:PRESet` or \*RST. The command neither has a query form nor an \*RST value.

Example: `:SOUR:ILS:GS:PRES`

**[:SOURCE]:ILS:LOCALizer**

The commands to specify the characteristics of the LOCALizerlocalizer modulation signal are under this node. Whether this signal is output, however, is determined by command SOURCE:ILS:TYPE.

**[:SOURCE]:ILS:LOCALizer:MODE NORM | LLOBe | RLOBe**

The command specifies the type of the ILS-LOC signal generated.

**NORM** ILS-LOC-Signal

**LLOBe** (Left LOBe) Amplitude modulation of the output signal using the SOURCE:ILS:LOC:LLOBe:FREQuency signal component (generally 90 Hz) of the ILS-LOC signal. The modulation depth

$$AM(90Hz) = 0.5 * (ILS:LOC:SODepth + ILS:LOC:DDM * 100\%)$$

and for SOURCE:ILS:GS:DDM:DIR LEFT from

$$AM(90Hz) = 0.5 * (ILS:LOC:SODepth ILS:LOC:DDM * 100\%)$$

**RLOBe** (Right LOBe) Amplitude modulation of the output signal using the SOURCE:ILS:LOC:RLOBe:FREQ signal component

(generally 150 Hz) of the ILS-LOC signal. The modulation depth

for ILS:LOC:DDM:DIR RIGHT results from

$$AM(150Hz) = 0.5 * (ILS:LOC:SODepth + ILS:LOC:DDM * 100\%)$$

and for ILS:LOC:DDM:DIR LEFT from

$$AM(150Hz) = 0.5 * (ILS:LOC:SODepth ILS:LOC:DDM * 100\%)$$

Example: :SOUR:ILS:LOC:MODE LLOB \*RST value is NORM

**[:SOURCE]:ILS:LOCALizer:COMid**

The commands to set the ComId content (communication/identification signal) of the ILS-LOC signal are under this node.

**[:SOURCE]:ILS:LOCALizer:COMid[:STATe] ON | OFF**

The command activates or deactivates the ComId signal. \*RST value is OFF

Example: :SOUR:ILS:LOC:COM:STAT ON

**[:SOURCE]:ILS:LOCALizer:COMid:FREQuency 0.1 to 20 000 Hz**

The command sets the frequency of the ComId signal. \*RST value is 1020 Hz

Example: :SOUR:ILS:LOC:COM:FREQ 1020

**[:SOURCE]:ILS:LOCALizer:COMid:DEPTH 0 to 100 PCT**

The command sets the AM modulation depth of the ComId signal.

Example: :SOUR:ILS:LOC:COM:DEPT 10PCT \*RST value is 10 PCT



**[[:SOURCE]:ILS:LOCALIZER:DDM**

(Difference in Depth of Modulation) The commands to set the modulation depth difference between the signal of the left lobe (90 Hz) and the right lobe (150 Hz) are under this node.

**[[:SOURCE]:ILS:LOCALIZER:DDM:CURRENT -387 to +387 uA**

The command alternatively enters the DDM value as a current by means of the ILS indicating instrument. This parameter is coupled with `SOURCE:ILS:LOC:DDM:DEPTH`.

Example: `:SOUR:ILS:LOC:DDM:CURR 0` \*RST value is 0 A

**[[:SOURCE]:ILS:LOCALIZER:DDM[:DEPTH] -0.4 to +0.4**

The command sets the difference of the modulation depth. This parameter is coupled with `SOURCE:ILS:LOC:DDM:CURRENT`. The following is true:

for `SOURCE:ILS:LOC:DDM:DIRECTION RIGHT`

$$\text{ILS:LOC:DDM:DEPTH} = (\text{AM}(90\text{Hz}) - \text{AM}(150\text{Hz}))/100\%$$

and for `SOURCE:ILS:LOC:DDM:DIRECTION LEFT`

$$\text{ILS:LOC:DDM:DEPTH} = (\text{AM}(150\text{Hz}) - \text{AM}(90\text{Hz}))/100\%$$

Example: `:SOUR:ILS:LOC:DDM:DEPT 0` \*RST value is 0

**[[:SOURCE]:ILS:LOCALIZER:DDM:DIRECTION LEFT | RIGHT**

The command enters the DDM value in dB. This parameter is coupled with `SOURCE:ILS:LOC:DDM:DEPTH`.

LEFT The airplane is too much to the right, it must turn to the left.

RIGHT The airplane is too much to the left, it must turn to the right.

Example: `:SOUR:ILS:LOC:DDM:DIR LEFT` \*RST value is LEFT

**[[:SOURCE]:ILS:LOCALIZER:DDM:LOGarithmic -999.9 dB to +999.9 dB**

The command enters the DDM value in dB. This parameter is coupled with `SOURCE:ILS:LOC:DDM:DEPTH` and `:CURRENT`.

Example: `:SOUR:ILS:LOC:DDM:LOG 0` \*RST value is 0.0 dB

**[[:SOURCE]:ILS:LOCALIZER:LLOBE**

The commands to configure the signals of the left ILS-LOC antenna lobe (Left LOBe) are under this node.

**[[:SOURCE]:ILS:LOCALIZER:LLOBE[:FREQUENCY] 60 to 120 Hz**

The command sets the frequency. Normally, it is 90 Hz. This parameter is coupled with `SOURCE:ILS:LOC:RLOBE:FREQUENCY`. As the ratio of `LLOBE:FREQUENCY` and `RLOBE:FREQUENCY` must always be 3/5, `RLOBE:FREQUENCY` is readjusted accordingly.

Example: `:SOUR:ILS:LOC:LLOB:FREQ 90` \*RST value is 90 Hz

**[[:SOURce]:ILS:LOCalizer:RLOBe**

The commands to configure the signal of the right ILS-LOC antenna lobe (Right LOBe) are under this node.

**[[:SOURce]:ILS:LOCalizer:RLOBe[:FREQuency] 100 to 200 Hz**

The command sets the frequency. Normally, it is 150 Hz. This parameter is coupled with SOURce:ILS:LOC:LLOBe:FREQuency. As the ratio of LLOBe:FREQuency and RLOBe:FREQuency must always be 3/5, LLOBe:FREQuency is readjusted accordingly.

Example: :SOUR:ILS:LOC:RLOB:FREQ 150 \*RST value is 150 Hz

**[[:SOURce]:ILS:LOCalizer:PHASe 0 to 120 deg**

The command sets the phase between the modulation signals of the left and the right antenna lobe. The zero crossing of the signal of the right lobe serves as a reference. The angle refers to the period of the signal of the right antenna lobe. \*RST value is 0

Example: :SOUR:ILS:LOC:PHAS 0deg

**[[:SOURce]:ILS:LOCalizer:PRESet**

This command is equivalent to the following command sequence:

```
:ILS:SOUR INT2
:ILS:STAT ON
:ILS:TYPE LOC
:ILS:LOC:MODE NORM
:ILS:LOC:COM OFF
:ILS:LOC:COM:FREQ 1020Hz
:ILS:LOC:COM:DEPT 10PCT
:ILS:LOC:DDM 0.0
:ILS:LOC:DDM:DIR LEFT
:ILS:LOC:SOD 40PCT
:ILS:LOC:LLOB 90Hz
:ILS:LOC:RLOB 150Hz
:ILS:LOC:PHAS 0
```

The values set correspond to the state after SYSTEM:PRESET or \*RST. The command neither has a query form nor an \*RST value.

Example: :SOUR:ILS:LOC:PRES

**[[:SOURce]:ILS:LOCalizer:SODePTH 0 to 100 PCT**

The command indicates the sum of modulation depths of the signals of the left lobe (90 Hz) and the right lobe (150 Hz).

Example: :SOUR:ILS:LOC:SOB 40PCT \*RST value is 40 PCT



**[[:SOURce]:LIST:DWELI 1 ms to 1 s {, 1 ms to 1 s}**

For every item of the FREQUency or POWer/VOLTage list contents, the command contains the time the instrument "dwells" at this item.

**Note:** *The RF generator is not in a position to allocate different times to the individual items of the FREQUency and POWer list contents. Thus the DWELI part of the list should have length 1; the value is then valid for all items. If a list containing more than one element is indicated, all values must be equal.*

Example: :SOUR:LIST:DWEL 0.15

**[[:SOURce]:LIST:DWELI:POINts?**

The command queries the length (in items) of the DWELI-part of the list. The command is a query and thus has no \*RST value.

Example: :SOUR:LIST:DWEL:POIN? Answer: 1

**[[:SOURce]:LIST:FREE?**

The command queries two values. The first one indicates the space still vacant for lists (in items), the second one the space already occupied, also in items. The command is a query and thus has no \*RST value.

Example: :SOUR:LIST:FREE? Answer: 2400, 200

**[[:SOURce]:LIST:FREQUency 5 kHz to 1.5 GHz {, 5 kHz to 1.5 GHz}| block data  
(SME03/06: 5 kHz to 3/6 GHz)**

The command fills the FREQUency part of the list selected with data. The data can either be indicated as a list of numbers (separated by commas) of arbitrary length or as binary block data. In the case of block data transmission, always 8 (4) bytes are interpreted as a floating-point number of double accuracy (cf. command FORMat :DATA). \*RST does not influence data lists.

Example: :SOUR:LIST:FREQ 1.4GHz, 1.3GHz, 1.2GHz, ...

**[[:SOURce]:LIST:FREQUency:POINts?**

The command queries the length (in items) of the FREQUency part of the list presently selected. The command is a query and thus has no \*RST value.

Example: :SOUR:LIST:FREQ:POIN? Answer: 327

**[[:SOURce]:LIST:LEARn**

The command learns the list selected. I.e., it determines the hardware setting for the entire list. The data thus determined are stored together with the list. The command triggers an event and thus has no \*RST value.

Example: :SOUR:LIST:LEAR

**Caution:** *This command has to be given after every creating and changing of a list.*

**[ :SOURCE]:LIST:MODE AUTO | STEP**

The command indicates the mode in which the list is to be processed (by analogy with SOURCE:SWEep:MODE).

AUTO Each trigger event triggers a complete list run.

STEP Each trigger event triggers only one step in processing the list.

Example: :SOUR:LIST:MODE STEP \*RST value is AUTO

**[ :SOURCE]:LIST:POWER -144 to 16 dBm {, -144 to 16 dBm} | block data**

The command fills the LEVEL part of the RF list selected with data. The data can either be indicated as a list of numbers (separated by commas) of arbitrary length or as binary block data. As to the format of the data, cf. command :SOURCE:LIST:FREQ. \*RST does not influence data lists.

Example: :SOUR:LIST:POW 0dBm, -2dBm, -2dBm, -3dBm,...

**[ :SOURCE]:LIST:POWER:POINts?**

The command queries the length (in items) of the LEVEL part of the list presently selected. The command is a query and thus has no \*RST value

Example: :SOUR:LIST:POW:POIN? Answer: 32

**[ :SOURCE]:LIST:SElect "Name of list"**

The command selects the list indicated. If there is no list of this name, a new list is created. The name may contain up to 7 letters. The command triggers an event and thus has no \*RST value

Example: :SOUR:LIST:SEL "LIST1"

### 3.6.11.10 SOURce:MARKer Subsystem

This subsystem contains the commands to check the marker generation with sweeps. The SME has three markers each for frequency and level sweeps which are differentiated by a numeric suffix after MARKer. The settings for frequency sweep and level sweep marker are independent of each other.

Command	Parameter	Default Unit	Remark
[:SOURce] :MARKer1 2 3 [:FSweep] :AMPLitude :AOFF :FREQuency [:STATe] :PSweep :AOFF :POWer [:STATe] :POLarity	ON   OFF 5 kHz to 1.5 GHz ON   OFF -144 to+16 dBm ON   OFF NORMal   INVerted	Hz   dBm	No query <b>SME03E/03/06:</b> 5 kHz to 2.2/3/6 GHz  No query

#### [:SOURce]:MARKer1|2|3[:FSweep]

The commands for the markers with frequency sweep are under this node. Keyword :FSweep can be omitted, then the command conforms to SCPI regulations.

#### [:SOURce]:MARKer1|2|3[:FSweep]:AMPLitude ON | OFF

The command specifies whether the marker influences the signal level.

ON The output level is reduced by a constant value when the marker frequency is executed.

OFF The output level remains unchanged. \*RST value is OFF

Example: :SOUR:MARK1:FSW:AMP ON

#### [:SOURce]:MARKer1|2|3[:FSweep]:AOFF

Command (All markers off) switches off all frequency markers. This command triggers an event, thus it has no \*RST value and no query form.

Example: :SOUR:MARK:FSW:AOFF

#### [:SOURce]:MARKer1|2|3[:FSweep]:FREQuency 5 kHz to 1.5 GHz (SME03E/03/06: 5 kHz to F/3/6 GHz)

The command sets the marker selected by the numeric suffix with MARKer to the frequency indicated.

In this command, the OFFSet value of the subsystem (menu) FREQuency is considered as with input value MARKer in the SWEEP-FREQ menu. Thus the specified range indicated is only valid for SOURce:FREQuency:OFFSet = 0. The specified range with other OFFSet values can be calculated according to the following formula (cf. Chapter 2, Section "Frequency Offset", as well):

5 kHz - OFFSet to 1.5 GHz - OFFSet \*RST value for MARK1: 100 MHz

MARK2: 200 MHz

MARK3: 300 MHz

Example: :SOUR:MARK1:FSW:FREQ 30MHz

**[[:SOURCE]:MARKER1|2|3[:FSweep][:STATe] ON | OFF**

The command switches the marker selected by the numeric suffix with MARKER on or off.

Example: :SOUR:MARK1:FSW:STAT ON \*RST value is OFF

**[[:SOURCE]:MARKER1|2|3:PSweep**

The commands for the markers with level sweep are under this node (Power sweep). The three markers are differentiated by a numeric suffix after MARKER.

**[[:SOURCE]:MARKER1|2|3:PSweep:AOff**

The command switches all level markers off. This command is an event and thus has no \*RST value and no query form.

Example: :SOUR:MARK:PSW:AOff

**[[:SOURCE]:MARKER1|2|3:PSweep:POWer -144 dBm to +16 dBm**

The command sets the marker selected by the numeric suffix with MARKER to the level indicated.

In this command, the OFFSet value of subsystem (menu) POWER (LEVEL) is considered in correspondence with input value MARKER in the SWEEP LEVEL menu. Thus the specified range indicated is only valid for SOURCE:POWer:OFFSet = 0. The specified range with other OFFSet values can be calculated according to the following formula (cf. Chapter 2, Section "Level Offset" as well):

-144 dBm OFFSet to 16 dBm OFFSet \*RST value for MARK1: 1 dBm

MARK2: 2 dBm

MARK3: 3 dBm

Example: :SOUR:MARK1:PSW:POW -2dBm

**[[:SOURCE]:MARKER1|2|3:PSweep[:STATe] ON | OFF**

The command switches the marker selected by the numeric suffix with MARKER on or off.

Example: :SOUR:MARK1:PSW:STAT ON \*RST value is OFF

**[[:SOURCE]:MARKER1|2|3:POLarity NORMal | INVerted**

The command specifies the polarity of the marker signal.

NORMal When running through the marker condition, TTL level is applied at the marker output, otherwise 0 V.

INVerted When running through the marker condition, 0 V is applied at the marker output, otherwise TTL level. \*RST value is NORM

Example: :SOUR:MARK:POL INV

### 3.6.11.11 SOURce:MBEacon Subsystem

This subsystem contains the commands to control the characteristics of the marker signals (Marker B<sub>E</sub>acon) as they are used to mark the distance in the approach range of airports (option SM-B6, multifunction generator).

Command	Parameter	Default Unit	Remark
[:SOURce] :MBEacon :STATe [:MARKer] :FREQuency :DEPTH :COMid [:STATe] :FREQuency :DEPTH	ON   OFF 400 Hz   1300 Hz   3000 Hz 0 to 100 PCT ON   OFF 0.1 to 20 000 Hz 0 to 100 PCT	Hz PCT Hz PCT	Option SM-B6

**[:SOURce]:MBEacon:STATe ON | OFF**

The command switches on or off the generation of marker beacon signals. STATe ON is only possible if no amplitude modulation is switched on. Modulation generator 2 must not be inserted simultaneously as a source for PM or FM either.

Example: :SOUR:MBE:STAT ON \*RST value is OFF

**[:SOURce]:MBEacon[:MARKer]:FREQuency 400 Hz | 1300 Hz | 3000 Hz**

The command selects the frequency of the marker signal. \*RST value is 400 Hz

Example: :SOUR:MBE:MARK:FREQ 400

**[:SOURce]:MBEacon[:MARKer]:DEPTH 0 to 100 PCT**

The command selects the frequency of the marker signal. \*RST value is 95 PCT

Example: :SOUR:MBE:MARK:DEPT 95PCT

**[:SOURce]:MBEacon:COMid[:STATe] ON | OFF**

The command activates or deactivates the ComId signal. \*RST value is OFF

Example: :SOUR:MBE:COM:STAT ON

**[:SOURce]:MBEacon:COMid:FREQuency 0.1 to 20 000 Hz**

The command sets the frequency of the ComId signal. \*RST value is 1020 Hz

Example: :SOUR:MBE:COM:FREQ 1020

**[:SOURce]:MBEacon:COMid:DEPTH 0 to 100 PCT**

The command sets the AM modulation depth of the ComId signal \*RST value is 5 PCT

Example: :SOUR:MBE:COM:DEPT 5PCT



## 3.6.11.12 SOURce:PHASe Subsystem

Command	Parameter	Default Unit	Remark
[:SOURce] :PHASe [:ADJust] :REFerence	-360 deg to +360 deg	rad	No query

**[:SOURce]:PHASe[:ADJust]** -360 deg to +360 deg

The command indicates the phase between output signal and reference oscillator signal. This setting is only accepted using SOURce:PHASe:REFerence (cf. below). An indication in RADian is possible.

Example: :SOUR:PHAS:ADJ 2DEG

:SOUR:PHAS:ADJ 0.1RAD

\*RST value is 0.0 DEG

**[:SOURce]:PHASe:REFerence**

The command accepts the phase set using SOURce:PHASe:ADJust as a new reference phase. The command has no \*RST value.

Example: :SOUR:PHAS:REF

### 3.6.11.13 SOURce:PM Subsystem

This subsystem contains the commands to check the phase modulation and to set the parameters of the modulation signal. The SME can be equipped with two independent phase modulators, PM1 and PM2 (option SM-B5). They are differentiated by a suffix after PM.

SOURce:PM1

SOURce:PM2

Command	Parameter	Default Unit	Remark
[:SOURce] :PM1 2			Option SM-B5
[:DEVIation]	-360 deg to +360 deg	rad	
:EXTernal1 2			
:COUPling	AC   DC		
:INTernal			
:FREQUency	400 kHz   1 kHz   3 kHz   15 kHz or 0.1Hz to 500 kHz or 0.1Hz to 1 MHz	Hz	Option SM-B2 or -B6
:SOURce	INT   EXT1   EXT2		
:STATe	ON   OFF		

**[:SOURce]:PM1|2[:DEVIation]** -360 to +360 deg

The command sets the modulation depth in Radian. DEGREE are accepted.

\*RST value is 1 rad

Example: SOUR:PM:DEV 20DEGR

**[:SOURce]:PM1|2:EXTernal1|2**

The commands to check the external input of the PM modulators are under this node. The settings under EXTernal for modulations AM, FM and PM are independent of each other. The settings are always related to the socket determined by the suffix after EXTernal. The suffix after PM is ignored then. With the following commands, e.g., the settings are both related to socket EXT2:

:SOUR:PM1:EXT2:COUP AC

:SOUR:PM2:EXT2:COUP AC

A command without suffix is interpreted like a command with suffix 1.

**[:SOURce]:PM1|2:EXTernal1|2:COUPling** AC | DC

The command selects the type of coupling for the external PM input.

AC The d.c. voltage content is separated from the modulation signal.

DC The modulation signal is not changed.

\*RST value is AC

Example: :SOUR:PM:COUP DC

**[[:SOURce]:PM1|2:INTernal]**

The settings for the internal PM generators are effected under this node. For PM1, this is always LF generator 1, for PM2, always LF generator 2. Here the same hardware is set for FM1, PM1, AM::INT1 as well as SOURce0, for FM2, PM2 and AM:INT2 and SOURce2 as well. This means that, e.g., the following commands are coupled with each other and have the same effect:

```
SOUR:AM:INT2:FREQ
SOUR:FM2:INT:FREQ
SOUR:PM2:INT:FREQ
SOUR2:FREQ:CW
```

**[[:SOURce]:PM1|2:INTernal:FREQuency]** 400 kHz | 1 kHz | 3 kHz | 15 kHz or 0.1 Hz to 500 kHz or 0.1 Hz to 1 MHz

The command sets the modulation frequency. There are different specified ranges depending on the equipment of the instrument:

If neither SM-B2 nor SM-B6 are fitted, only INT1 is permissible and values 400 Hz, 1 kHz, 3 kHz and 15 kHz are valid. With option SM-B2, the specified range from 0.1 Hz to 500 kHz is valid, with SM-B6 from 0.1 to 1 MHz: \*RST value is 1 kHz

Example: :SOUR:PM:INT:FREQ 10kHz

**[[:SOURce]:PM1|2:SOURce]** INTernal | EXTernal1 | EXTernal2

The command selects the modulation source. A command without suffix is interpreted like a command with suffix 1. LF generator 1 is INTernal for PM1, LF generator2 for PM2 (option SM-B5). Several modulation sources can be active at the same time (see example)

\*RST value for PM1: INT

Example: :SOUR:PM:SOUR INT, EXT2 for PM2:EXT2

**[[:SOURce]:PM1|2:STATe]** ON | OFF

The command switches the phase modulation selected by the numeric suffix with PM on or off.

Example: :SOUR:PM1:STAT OFF \*RST value is OFF

### 3.6.11.14 SOURce:POCSag Subsystem

POCSAG is a standard which in its various implementations (e.g. CITYRUF, SCALL) allows convenient paging. When equipped with the SME-B42 (POCSAG), SME-B11 (DM coder) and SME B12 (DM memory extension) options, the SME generates call signals complying to the POCSAG standard. All essential parameters and the message to be transmitted are freely selectable.

Command	Parameter	Default Unit	Remark
[:SOURce] :POCSag			
:STATe	ON   OFF		
:MODulation	FSK   FFSK		
:BRATe	512bps   1200bps   2400bps		
:DEVIation	1.5   2.0   3.0   3.5   4.0   4.5 kHz	Hz	
:ERRor			
:MASK	0 to 4294967295		
:WORD	0 to 16		
:LBATches	0 to 100		
:MESSage			
:ADDRes	0 to 2097151		
:CATegory	NUMeric   TONE   ALPHanumeric		
:SWORd	POCSag   INForuf		
:TONE	A   B   C   D		
:NUMeric	"string"		
:ALPHanumeric			
[:SElect]	"FOX"   "ALPHA"   "USER1 to 4"		
:CATalog?			Query only
:DATA	"alphanumeric data"		
:POLarity	NORMal   INVerted		
:TSLice	2 to 120 s	s	
:TACTion	MESSage   START   ONCE		

#### [:SOURce]:POCSag:STATe ON| OFF

The command switches all of the other active DM modulation settings off. In contrast to ERMES, the RF frequency is not changed. Each time OFF is switched to ON, the data for the memory expansion are recalculated and written into the "XMEM" list. The data must be recalculated whenever any POCSAG parameter other than POCSag:DEVIation is changed. This means that STATe OFF should be briefly activated after every change.

Example: :SOUR:POCS:STAT ON

\*RST value is OFF

#### [:SOURce]:POCSag:MODulation FSK | FFSK

The command selects the desired modulation.

Two types are available for POCSAG, FSK und FFSK.

FSK The RF is directly modulated with the data signal.

FFSK An LF is first modulated, which is then used as the modulation signal for the RF.

Example: :SOUR:POCS:MOD FSK

\*RST value is FSK

**[[:SOURce]:POCSag:DEViation 1.5 | 2.0 | 3.0 | 3.5 | 4.0 | 4.5 kHz**

The command enters the input value of the frequency deviation for the set modulation.

For FSK 4.0 kHz and 4.5 kHz are possible, for FFSK 1.5 kHz, 2.0 kHz, 3.0 kHz, 3.5 kHz, 4.0 kHz and 4.5 kHz. The instrument stores two independent deviation values (one for each type of modulation). The value which is displayed and used depends on the modulation setting.

Example: :SOUR:POCS:DEV 4.5kHz \*RST value is 4kHz

**[[:SOURce]:POCSag:BRATe 512bps | 1200bps | 2400bps**

The command selects the bitrate, at which the data should be outputted. Possible values are: 512, 1200, and 2400 baud.

Example: :SOUR:POCS:BRAT 512bps \*RST value is 512bps

**[[:SOURce]:POCSag:ERRor:MASK 0 to 4294967295**

The command determines the erroneous bits in a 32-bit field. The transmitted decimal number (0...4294967295) is converted internally into a 32-bit binary number and thus defines the 32 bits. These bits are XORed with the word of the message which is to be falsified and thus determine which bits of this word are to be transmitted correctly or incorrectly.

Example: :SOUR:POCS:ERRor:MASK 0 \*RST value is 0.

**[[:SOURce]:POCSag:ERRor:WORD 0 to 16**

The command determines the position of the word to be falsified in the batch. Value 0 denotes the synchronization word.

Example: :SOUR:POCS:ERRor:WORD 0 \*RST value is 0.

**[[:SOURce]:POCSag:LBATches 0 to 100**

The command sets the number of filler batches which are transmitted before the message (Leading BATches). \*RST value : 0

Example: :SOUR:POCS:LBAT 0

**[[:SOURce]:POCSag:MESSage**

The parameters of this section are used for setting the destination address as well as the useful data of the message.

**[[:SOURce]:POCSag:MESSage:ADDRess 0 to 2097151**

The command sets the address of the pager to be called. The specified range is 0 to 2097151.

Example: :SOUR:POCS:MESS:ADDR 1 \*RST value is 1

**[[:SOURce]:POCSag:MESSage:CATegory NUMeric | TONE | ALPHAnumeric**

The command selects the category of the transmitted message.

TONETone-only message

NUMeric Numeric message,

ALPHAnumeric Alphanumeric message. \*RST value is TONE

Example: :SOUR:POCS:MESS:CAT TONE

**[[:SOURce]:POCSag:MESSAge:SWORd POCSag | INForuf**

The command selects the contents of the sync word. This word distinguishes between the various types of paging services.

POCSAG 0x7CD215D8; also used for CITYRUF

INFORUF 0x7CD21436.

\*RST value is POCSag

Example: :SOUR:POCS:MESS:SWOR POCS

**[[:SOURce]:POCSag:MESSAge:TONE A | B | C | D**

The command selects the tone which is transmitted during category TONE. Four tones are available (A, B, C, D).

**Note:** *Only true tone-only receivers can process all four possible values. Numerical and alphanumeric receivers react to tone-only pages only when tone number is B or C.*

Example: :SOUR:POCS:MESS:TONE B

\*RST value is TONE

**[[:SOURce]:POCSag:MESSAge:NUMeric "String"**

The command determines the type of character string the numeric message may consist of. SME allows a maximum of 41 characters. In addition to the 10 figures "0" to "9" other characters such as square brackets right and left "[", "]", upper case letter "U", hyphen "-" and blank space " " can be used.

Example: :SOUR:POCS:MESS:NUM "12-17"

\*RST value is 0123456789 U-[]

**[[:SOURce]:POCSag:MESSAge:ALPHAnumeric**

This node contains commands for the determination of the contents of the alphanumeric messages. There is one common character set for FLEX and POGSAG. These commands can only be activated if `POCS:MESSAge:CATegory ALPHAnumeric` is selected.

**[[:SOURce]:POCSag:MESSAge:ALPHAnumeric[:SElect] "FOX" | "ALPHA" | "USER 1" | "USER2" | "USER3" | "USER4"**

The command selects the alphanumeric message. The following selection can be made:

"FOX" The quick brown fox jumps over the lazy dog

"ALPHA" ABCD to (complete POGSAG character set)

"USER1 to 4" 4 messages that can be freely edited by command `ALPHAnumeric:DATA`.

Example: :SOUR:POCS:MESS:ALPH:SEL "FOX"

\*RST value is USER3

**[[:SOURce]:POCSag:MESSAge:ALPHAnumeric:CATalog?**

The command queries the alphanumeric messages available. It causes a list to be returned on which the entries are separated by commas. The command is a query command and thus has no \*RST value.

Example: :SOUR:POCS:MESS:ALPH:CAT?

Answer: FOX, ALPHA, USER1

**[[:SOURce]:POCSag:MESSAge:ALPHAnumeric:DATA "String"**

The command allows any character string to be entered into one of the alphanumeric messages USER 1 to 4. This message has to be selected first with the command `ALPHAnumeric:SElect`.

\*RST value is "" (eg, empty message)

Example: :SOUR:POCS:MESS:ALPH:DATA "Hello"

**[[:SOURCE]:POCSag:POLarity** NORMal | INVerted

The command sets the polarity of the modulation.

**NORMal** The polarity of the modulation is set according to standard POCSAG.

**INVerted** The polarity of the modulation is inverted.

Example: :SOUR:POCS:POL NORM

\*RST value is NORM

**[[:SOURCE]:POCSag:TSLice** 2 to 120 s

The command determines the length of the time slice. Possible values are: 2 to 120 sec. A preamble of 576 bits is sent at the beginning of every time slice, followed by the number of filler batches set with command *POCS:LBAT*. Each batch has the length of 544 bits.

Depending on the settings under commands *POCS:TACT* and *TRIG:DM*, zero, one or two message batches follow. Then an unmodulated signal is sent up to the end of the time slice.

Due to the fact that only complete code word groups are sent, it is possible that, depending on the set bit rate, the length of the actual time slice slightly differs from the set value of time slice length.

Example: :SOUR:POCS:TSL 10

\*RST value is 10

**[[:SOURCE]:POCSag:TACTion** MESSage | START | ONCE

This command (Trigger ACTion) determines the action which is activated by a trigger event. The valid trigger events are specified by command *TRIGger:DM:SOURCE*. This command also defines the allocation between manual and remote-control operations.

**MESSage** A trigger event switches from filler data output to useful data output for the duration of a time slice. The filler data are then output again.

**START** Digital modulation is started by a trigger event. Useful data are then continuously output according to the settings.  
This setting is suitable, for example, for a synchronous start of several units.

**ONCE** The output of a time slice is only started by a valid trigger event. After recognition of this signal, exactly one time slice is output. After that, the SME waits for its trigger pulse again (defined under *TRIG:DM:SOURCE*).

Example: SOUR:POCS:TACT MESS

\*RST value is MESSage

**3.6.11.15 SOURce:POWer Subsystem**

This subsystem contains the commands to set the output level, the level control and the level correction of the RF signal. Other units can be used instead of dBm:

- by indication directly after the numeric value (Example :POW 0.5V),
- by altering the DEFault unit in the UNIT system (see Command :UNIT:POWER)

Command	Parameter	Default Unit	Remark
[:SOURce] :POWer :ALC :BANDwidth   BWIDth :AUTO [:STATe] [:LEVel] [:IMMediate] [AMPLitude] :OFFSet :RCL :LIMit [:AMPLitude] :MANual :MODE :STARt :STOP :STEP [:INCRement]	100 kHz   500 kHz ON   OFF   ONCE ON   OFF -144 to +16 dBm -100 to +100 dB INCLude   EXCLude -144 to +16 dBm -144 to +16 dBm FIXed   SWEEp   LIST -144 to +16 dBm -144 to +16 dBm 0.1 to 10 dB	Hz    dBm dB  dBm dBm  dBm dBm  dB	

**[:SOURce]:POWer:ALC**

The commands checking the automatic level control are under this node.

**[:SOURce]:POWer:ALC:BANDwidth|BWIDth 100 kHz | 500 kHz**

The command sets the bandwidth of the level control.

\*RST value is 100 kHz

Example: :SOUR:POW:ALC:BAND 100kHz

**[:SOURce]:POWer:ALC:BANDwidth | BWIDth:AUTO ON | OFF | ONCE**

The command determines the mode in adapting the bandwidth.

ON The bandwidth is automatically adapted.

OFF No bandwidth adaptation.

ONCE The bandwidth is adapted once, then AUTO is automatically set to OFF.

Example: :SOUR:POW:ALC:BAND:AUTO ON

\*RST value is ON



**[[:SOURce]:POWER:ALC[:STATe] ON | OFF** Fehler! Textmarke nicht definiert.

The command switches level control on or off.

ON Level control is permanently switched on.

OFF Level control is switched on for a short period of time if the level changes.

Example: :SOUR:POW :ALC:STAT ON \*RST value is ON

**[[:SOURce]:POWER[:LEVel][:IMMediate][:AMPLitude] -144 to +16 dBm**

The command sets the RF output level in operating mode CW. UP and DOWN can be indicated in addition to numeric values. Then the level is increased or reduced by the value indicated under :SOURce:POWer:STEP.

In this command, the OFFSet value is considered as with input value AMPLITUDE in the LEVEL-LEVEL menu. Thus the specified range indicated is only valid for :POWer:OFFSet = 0. The specified range with other OFFSet values can be calculated according to the following formula (cf. Chapter 2, Section "Level Offset" as well):

$$-144\text{dBm} + \text{OFFSet} \text{ to } +16\text{dBm} + \text{OFFSet}$$

The keywords of this command are optional to a large extent, thus the long as well as the short form of the command is shown in the example. \*RST value is -30 dBm

Example: :SOUR:POW:LEV:IMM:AMPL 15 or  
:POW 15

**[[:SOURce]:POWER[:LEVel][:IMMediate][:AMPLitude]:OFFSet -100 to +100 dB**

The command enters the constant level offset of a series-connected attenuator/ amplifier (cf. Chapter 2, Section "Level Offset"). If a level offset is entered, the level entered using :POWer:AMPLitude does no longer conform to the RF output level. The following connection is true:

$$\text{:POWer} = \text{RF output level} + \text{POWer:OFFSet.}$$

Entering a level offset does not change the RF output level but only the query value of :POWer:AMPLitude.

Only dB is permissible as a unit here, linear units (V, W etc.) are not permitted.

**Caution:** *The level offset is also valid in the case of level sweeps!*

Example: :SOUR:POW:LEV:IMM:AMPL:OFFS 0 oder \*RST value is 0  
:POW:OFFS 0

**[[:SOURce]:POWER[:LEVel][:IMMediate][:AMPLitude]:RCL INCLude | EXCLude**

The command determines the effect of the recall function on the RF level. \*RST value has no effect to this setting.

INCLude The saved RF level is loaded when instrument settings are loaded with the [RECALL] key or with a memory sequence.

EXCLude The RF level is not loaded when instrument settings are loaded, the current settings are maintained.

Example: :SOUR:POW:RCL INCL

**[[:SOURCE]:POWER:LIMit[:AMPLitude] -144 to +16 dBm**

The command limits the maximum Rf output level in operating mode CW and SWEEP. It does not influence the display LEVEL and the answer to query POW?.

Example: :SOUR:POW:LIM:AMPL 15 \*RST value is +16 dBm

**[[:SOURCE]:POWER:MANual -144 to +16 dBm**

The command sets the level if SOURCE:POWER:MODE is set to SWEEP and SOURCE:SWEEP:MODE to MANUAL. Only level values between START and STOP are permissible. (As to specified range, cf. :POWER). \*RST value is -30 dBm

Example: :SOUR:POW:MAN 1dBm

**[[:SOURCE]:POWER:MODE FIXed | SWEEp | LIST**

The command specifies the operating mode and thus also by means of which commands the level setting is checked.

**FIXed** The output level is specified by means of commands under :SOURCE:POWER:LEVEL.

**SWEEp** The instrument operates in the SWEEP mode. The level is specified by means of :SOURCE:POWER:START; STOP; CENTer; SPAN and MANuAl.

**LIST** The instrument processes a list of frequency and level settings. The settings are effected in the SOURCE:LIST subsystem.

Setting :SOURCE:POWER:MODE LIST automatically sets command :SOURCE:FREQuency :MODE to LIST as well. \*RST value is FIXed

Example: :SOUR:POW:MODE FIX

**[[:SOURCE]:POWER:START -144 to +16 dBm**

The command sets the starting value for a level sweep. START may be larger than STOP, then the sweep runs from the high to the low level (As to specified range, cf. :POWER:AMPLitude).

Example: :SOUR:POW:STAR -20 \*RST value is -30dBm

**[[:SOURCE]:POWER:STOP -144 to +16 dBm**

The command sets the final value for a level sweep. STOP may be smaller than START. (As to specified range, cf. :POWER:AMPLitude). \*RST value is -10dBm

Example: :SOUR:POW:STOP 3

**[[:SOURCE]:POWER:STEP[:INCRement] 0.1 to 10 dB**

The command sets the step width with the level setting if UP and DOWN are used as level values. The command is coupled with KNOB STEP in the manual control, i.e., it also specifies the step width of the shaft encoder.

Only dB is permissible as a unit here, the linear units (V, W etc.) are not permitted.

Example: :SOUR:POW:STEP:INCR 2 \*RST value is 1dB

### 3.6.11.16 SOURce:PULM Subsystem

This subsystem contains the commands to check the pulse modulation and to set the parameters of the modulation signal. The internal pulse generator (option SM-B4) is set in the SOURce:PULSe subsystem.

Command	Parameter	Default Unit	Remark
[:SOURce] :PULM EXTernal :IMPedance :INTernal :FREQuency :POLarity :SOURce :STATe	50 Ohm   10 kOhm  0.01176 Hz to 10 MHz NORMal   INVerted INTernal   EXTernal ON   OFF	Ohm  Hz	Option SM-B3, SM-B4, SM-B8, and SM-B9

#### [:SOURce]:PULM:EXTernal:IMPedance 50 Ohm | 10 kOhm

The command sets the impedance of the input socket for the external pulse generator. The pulse generator has an own input socket, hence this setting is independent of the corresponding settings under PM and FM. \*RST value is 10 kOhm

Example: :SOUR:PULM:EXT:IMP 10E3

#### [:SOURce]:PULM:INTernal:FREQuency 0.01176 Hz to 10 MHz

The command sets the frequency of the pulse generator. This parameter is coupled with SOURce:PULSe:PERiod. \*RST value is 100 kHz

Example: :SOUR:PULM:INT:FREQ 1MHz

#### [:SOURce]:PULM:POLarity NORMal | INVerted

The command specifies the polarity between modulating and modulated signal.

NORMal The RF signal is suppressed during the interpulse period.

INVerted The RF signal is suppressed during the pulse.

Example: :SOUR:PULM:POL INV

\*RST value is NORMal

#### [:SOURce]:PULM:SOURce EXTernal | INTernal

The command selects the source of the modulating signal.

INTernal Internal pulse generator (option SM-B4).

EXTernal Signal fed externally

Example: :SOUR:PULM:SOUR INT

\*RST value is INTernal

#### [:SOURce]:PULM:STATe ON | OFF

The command switches on or off the pulse modulation.

\*RST value is OFF

Example: :SOUR:PULM:STAT ON

### 3.6.11.17 SOURce:PULSe Subsystem

This subsystem contains the commands to set the pulse generator (option SM-B4). The pulse generation is triggered on principle, with the trigger certainly being able to be set to "free run" using TRIGger:PULSe:SOURce AUTO as well. The pulse modulation (option SM-B3) is set in the SOURce:PULM subsystem.

Command	Parameter	Default Unit	Remark
[:SOURce] :PULSe			Option SM-B4
:DELay	40 ns to 1 s	s	
:DOUBle			
:DELay	60 ns to 1 s	s	
[:STATe]	ON   OFF		
:PERiod	100 ns to 85 s	s	
:WIDTh	20 ns to 1 s	s	

**[:SOURce]:PULSe:DELay 40 ns to 1 s**

The command specifies the time from the start of the period to the first edge of the pulse. Due to the construction of the instrument, this parameter is set to 0 if :SOURce:PULSe:DOUBle:STATe is set to ON. The old value is activated again as soon as the double pulse has been switched off.

Example: :SOUR:PULS:DEL 10us \*RST value is 1 us

**[:SOURce]:PULSe:DOUBle**

The commands to check the second pulse are under this node. If :SOURce:PULSe:DOUBle:STATe is set to ON, a second pulse whose width is identical to the first pulse is generated in every period.

**[:SOURce]:PULSe:DOUBle:DELay 60 ns to 1 s**

The command sets the time from the start of the pulse period to the first edge of the second pulse. \*RST value is 1 us

Example: :SOUR:PULS:DOUB:DEL 10us

**[:SOURce]:PULSe:DOUBle[:STATe] ON | OFF**

The command switches the second pulse on or off.

ON The second pulse is switched on. Parameter :SOURce:PULSe:DELay is set to 0 and cannot be changed. WIDTH > (PULSe:PERiod - PULSe:DOUBle:DELay)/2 results in error message -221, "Settings conflict".

OFF The second pulse is switched off. \*RST value is OFF

Example: :SOUR:PULS:DOUB:STAT OFF

**[:SOURce]:PULSe:PERiod 100 ns to 85 s**

The command sets the pulse period.

The pulse period is the reciprocal value of the pulse frequency, thus this command is coupled to command :SOURce:PULM:INTernal:FREQuency \*RST value is 10 us

Example: :SOUR:PULS:PER 2s

**[:SOURce]:PULSe:WIDTh 20 ns to 1s**

The command sets the pulse width. \*RST value is 1 us

Example: :SOUR:PULS:WIDT 0.1s

### 3.6.11.18 SOURCE:REFLEX25 Subsystem

This subsystem contains the commands for setting the ReFLEX25 signal. The telegram generated by the SME complies with the ReFLEX25 Protocol Specification Document Version 2.4 dated March 15, 1996, issued by the Motorola Advanced Messaging Group. ReFLEX25 can only be activated if the SME is equipped with the SME-B43, SME-B11 and SME-B12 options.

Command	Parameter	Default Unit	Remark
[:SOURCE]			Options SME-B11, SME-B12 and SME-B43
:REFLEX25			
:STATe	ON   OFF		
:AUTO	ON   OFF		
:MODulation	1600, FSK2   3200,FSK2   3200,FSK4   6400, FSK4	Hz	
:DEViation	2.0 to 10.0 kHz		
:MESSage			
:PADDRESS			
:ALPHAnumeric	16777216 to 1073741823		
[:SElect]			
:CATalog?	"name"		query only
:DATA	"alphanumeric data"		
:NUMeric	"numeric data"		
:RREQUIRED	ON   OFF		
:SI   SINformation			
:ZONE			
:SZONe	0 to 4091		
:PROVider	0 to 127		
:FCHannel	0 to 16383		
:BASE		Hz	
:ANUMber	0 to 8191MHz		
:RCHannel	0 to 2047		
:BASE		Hz	
:ANUMber	0 to 8191MHz		
:SPEEd	0 to 2047	bps	
:FSPacing	800   1600   6400   9600 bps	Hz	
:SCIBase	0 to 102350 Hz		
:SCICollapse	0 to 127		
:ERRor	0 to 7		
:MASK			
:WORD	0 to 4294967295		
:FCONtent	0 to 351		
:AADaptation	" A N T S R B F O 1 2 3 4 5 6 7 8 9  . A N T S R B F O 1 2 3 4 5 6 7 8 9 "		
:TACTion	ON   OFF		
	MESSage   START   ONCE		

**[:SOURce]:REFLex25:STATe ON | OFF**

This command switches on ReFLEX25. The status line displays the cycle and frame number and the type of output data as well as the word "RFLX" (see table in the Manual Operation part under FRAME CONTENTS).

When ReFLEX25 is switched on, all other DM modulations are automatically switched off.

A switchover from STAT OFF to STAT ON results in a recalculation of the telegram and its entry into the list "XMEM". Changing one of the ReFLEX parameters, except for REFL25:AAD, :TRIG:DM:SOUR and REFL25:FCON, requires a recalculation of data. The recalculation of data is effected by switchover to REFL25:STAT OFF; STAT ON

To permit easier handling, a few settings are automatically updated each time ReFLEX25 is switched on if other settings have been changed. This applies to SOUR:FREQ. Normally, automatic mode is activated, but it can be deactivated using REFL25:AAD OFF. Parameters that have been set automatically can be varied again at will, these modifications take effect immediately.

Example: :SOUR:REFL25:STAT ON \*RST value is OFF

**[:SOURce]:REFLex25:STATe:AUTO ON | OFF**

The command determines whether the ReFLEX telegram is to be recalculated after switchover from REFL25:STATE OFF to ON.

ON The data are recalculated.

OFF The previous memory extension contents are maintained.

This setting makes sense if the data in the memory extension have been altered by an external program; see also Manual Operation part under ReFLEX25, section „Further Notes: Reading Out, Modifying, Returning of Program Parts“.

Example :SOUR:REFL25:STAT:AUTO ON \*RST value is ON

**[:SOURce]:REFLex25:MODulation 1600,FSK2 | 3200,FSK2 | 3200,FSK4 | 6400,FSK4**

This command selects the used bit rate and modulation. Four modulations are available: 1600bps/2FSK, 3200bps/2FSK, 3200bps/4FSK and 6400bps/4FSK.

Example: :SOUR:REFL25:MOD 1600,FSK2 \*RST value is 1600,FSK2

**[:SOURce]:REFLex25:DEVIation 2.0 to 10.0 kHz**

This command determines the frequency deviation of the modulation. The deviation specifies the spacing from the carrier to the two further placed symbol in 4FSK. The ReFLEX25 standard specifies 2400Hz for this value which may be varied for testing. \*RST value is 2.4 kHz

Example: SOUR:REFL25:DEV 5 kHz

**[:SOURce]:REFLex25:MESSAge:PADDress 16777216 to 1073741823**

This command determines the address of the receiver to be called. The values range from 16 777 216 to 1 073 741 823. \*RST value is 16777216

Example: :SOUR:REFL25:MESS:PADD 167772168

**[[:SOURCE]:REFLEX25:MESSAGE:ALPHANumeric[:SElect] "name"**

This command selects the alphanumeric message. Valid values:

FOX Selection of an alphanumeric message.

ALPHA „ABCD..." (complete ReFLEX25 character set)

USER1 to 4 4 messages that can be freely varied using command REFL25:MESS:ALPH:DATA

The parameter is not influenced by \*RST.

Example: SOUR:REFL25:MESS:ALPH:SEL "FOX"

**[[:SOURCE]:REFLEX25:MESSAGE:ALPHANumeric:CATalog?**

The command queries the alphanumeric messages. It causes a list to be returned on which the entries are separated by commas. The list contains the values FOX, ALPHA, USER1, USER2, USER3, USER4. This is a query, it features no \*RST value.

Example: SOUR:REFL25:MESS:ALPH:CAT?

**[[:SOURCE]:REFLEX25:MESSAGE:ALPHANumeric:DATA "alphanumeric data string"**

This command is used to fill the list selected using REFL25:MESS:ALPH:SEL with the transferred data. The string may contain a maximum of 128 characters which must be part of the alphabet defined in the ReFLEX25 documentation. ReFLEX25 and Flex share a common set of messages - changing ReFLEX25 causes the message under Flex to be changed as well. The messages are not influenced by \*RST.

Example: SOUR:REFL25:MESS:ALPH:DATA "hello"

**[[:SOURCE]:REFLEX25:MESSAGE:NUMeric "numeric data string"**

This command enters the character string for a numeric message. The „numeric data string" may contain a maximum of 41 characters. In addition to the 10 figures "0" to "9" other characters such as square brackets left and right "[", "]", upper-case letter "U", hyphen "-" and blank space " " can be used. The parameter is not influenced by \*RST.

Example: SOUR:REFL25:MESS:NUM "[49-89-]1111-2222"

**[[:SOURCE]:REFLEX25:MESSAGE:RREquired ON | OFF**

This command determines whether the receiver is to confirm the message or not. The respective bit is set in the message. In the case of OFF, the vector field is reduced by one code word if this is permitted by the ReFLEX standard. \*RST value is OFF

Example: SOUR:REFL25:MESS:RREQ ON

**[[:SOURCE]:REFLEX25:SI | SINformation:ZONE 0 to 4091**

This command sets the geographical transmit zone. The significance is specified by the network operator. The value 0 is referred to as "restricted" in the ReFLEX25 documentation, but can be set for test purposes. The upper limit is 4091. \*RST value is 1

Example: SOUR:REFL25:SI:ZONE 91

**[[:SOURce]:REFLex25:SI | SINFormation:SZONe 0 to 127**

This command sets the subzone within a transmit zone. The significance is specified by the network operator. The value 0 is referred to as “restricted” in the ReFLEX25 documentation, but can be set for test purposes. The upper limit is 127. \*RST value is 1

Example: `SOUR:REFL25:SI:SZON 99`

**[[:SOURce]:REFLex25:SI | SINFormation:PROVider 0 to 16383**

This command sets the ID of the service provider. \*RST value is 0

Example: `SOUR:REFL25:SI:PROV 6383`

**[[:SOURce]:REFLex25:SI | SINFormation:FCHannel**

Together with `:REFL25:SI:FSP`, the commands under this node specify the frequency of the channel from the transmitter (SME) to the receiver. The following formula is valid:

$$:FREQ = :REFL25:SI:FCH:BASE + :REFL25:SI:FCH:ANUM * :REFL25:SI:FSPacing$$

If `:REFL25:AADaptation` is set to ON, the frequency calculated is also transferred to the RF setting of the SME when switching on ReFLEX25, provided that the formula provides a value that lies within the setting range of the SME.

The preset values for the following parameters are selected such that the default value of 929.00625MHz specified in the ReFLEX25 documentation is obtained as frequency.

**[[:SOURce]:REFLex25:SI | SINFormation:FCHannel:BASE 0 to 8191 MHz**

This command sets the base frequency of forward channel. \*RST value is 929 MHz

Example: `SOUR:REFL25:SI:FCH:BASE 81 MHz`

**[[:SOURce] :REFLex25:SI | SINFormation:FCHannel:ANUMber 0 to 2047**

This command sets the assignment number of forward channel. This is *not* the logic channel number.

Example: `SOUR:REFL25:SI:FCH:ANUM 204` \*RST value is 1

**[[:SOURce]:REFLex25:SI | SINFormation:RCHannel**

Together with `:REFL25:SI:FSPacing`, the commands under this node specify the frequency of the reverse channel from the receiver to the transmitter (SME). The following formula is valid in this case:

$$:FREQ = :REFL25:SI:RCH:BASE + :REFL25:SI:RCH:ANUM * :REFL25:SI:FSPacing$$

The preset values for the following parameters are selected such that the default value of 896.0125 MHz defined in the ReFLEX25 documentation is obtained as frequency

**[[:SOURce]:REFLex25:SI | SINFormation:RCHannel:BASE 0 to 8191 MHz**

This command sets the base frequency of reverse channel. \*RST value is 896 MHz

Example: `SOUR:REFL25:SI:RCH:BASE 550 MHz`

**[[:SOURce]:REFLex25:SI | SINFormation:RCHannel:ANUMber 0 to 204**

This command sets the assignment number of reverse channel. \*RST value is 2

Example: `SOUR:REFL25:SI:RCH:ANUM 204`



**[[:SOURCE]:REFLex25:SI | SINFORMATION:RCHannel:SPEEd 800 | 1600 | 6400 | 9600 bps**

This command selects the bit rate of the reverse channel. 800bps, 1600bps, 6400bps and 9600bps are available. The set value is transferred to the receiver and has no further effects.

Example:        SOUR:REFL25:SI:RCH:SPE 800 bps                                \*RST value is 800 bps

**[[:SOURCE]:REFLex25:SI | SINFORMATION:FSPacing 0 to 102350 Hz**

This command specifies the frequency spacing according to the formulas for FREQ given above. This parameter applies both to the forward and the reverse channel. Valid values are 0 to 102350Hz, in steps of 50Hz.                                \*RST value is 6250 Hz

Example:        SOUR:REFL25:SI:FSP 589 Hz

**[[:SOURCE]:REFLex25:SI | SINFORMATION:SCIBase 0 to 127**

System configuration information (SCI) frames are sent within each cycle of 128 frames. Their positions within the cycle are calculated according to

$INDEX = SCI\ BASE\ FRAME + 2^{SCI\ COLLAPSE\ MASK * i}$  for all i until INDEX exceeds 127.

:REFL25:SI:SCIBase and :REFL25:SI:SCICollapse are transferred to the receiver in the respective block information words.                                \*RST value is 0

Example:        SOUR:REFL25:SI:SCIB 99

**[[:SOURCE]:REFLex25:SI | SINFORMATION:SCICollapse 0 to 7**

See explanation under :REFL25:SI:SCIB.                                \*RST value is 7

Example:        SOUR:REFL25:SI:SCIC 5

**[[:SOURCE]:REFLex25:ERRor**

The SME allows for providing a 32-bit word of the transferred message with bit errors for test purposes. The following parameters specify the bits to be falsified and the position of the erroneous word within a frame. The bit errors are incorporated before the individual blocks are subjected to interleaving (see ReFLEX documentation).

**[[:SOURCE]:REFLex25:ERRor:MASK 0 to 4294967295**

This command sets the bits to be falsified. The set decimal number is converted internally into a 32-bit binary number. This binary number is XORed with the original message word. Each bit of the ERROR BIT MASK set to 1 causes the respective bit to be inverted in the transmitted word.

Example:        SOUR:REFL25:ERR:MASK 4967295                                \*RST value is 0

**[[:SOURCE]:REFLex25:ERRor:WORD 0 to 351**

This command indicates the position of the erroneous word. The erroneous word appears in each frame. Counting starts with the first word of block 0 of each frame, i.e. immediately after the sync partition; the sync partition cannot be falsified. Values from 0 to 351 can be set. Depending on the modulation, a frame (without sync partition) consists of 88, 176 or 352 words. If an excessive value is entered for REFL25:ERR:WORD for the modulation set, no bit errors are produced.

Example:        SOUR:REFL25:ERR:WORD 176                                \*RST value is 0

**[:SOURce]:REFLex25:FCONtent** "I|A|N|T|S|R|B|F|O|1|2|3|4|5|6|7|8|9  
[,I|A|N|T|S|R|B|F|O|1|2|3|4|5|6|7|8|9]"

This command specifies the contents of the max. 128 frames the SME sends during a cycle. A string with a length of max. 128 characters can be transferred. Each of the 128 frames is represented by a character which may assume one of the following values:

Character	Status display	Frame contents
I	IDLE	ReFLEX25 frame without addresses and message contents
A	ALPH	ReFLEX25 frame with alphanumeric message and address
N	NUM	ReFLEX25 frame with numeric message and address
T	TONE	ReFLEX25 frame with tone-only message and address
S	SCI	SCI frame
R	RSYN	Emergency Resynchronization Frame
B	BER	ReFLEX25 frame with a message that switches the receiver to the bit-error-test mode
F	FPAT	ReFLEX25 test filler pattern according to section 10.1 of the ReFLEX25 standard
O	OTH	Simulated data of another radiocommunication service; contains no ReFLEX structures at all.
1 to 9	CUS1 to CUS9	Custom frames, freely definable by the user (see instructions in the manual operation part)

- Notes:** – A cycle can be reduced to less than 128 frames by transferring a string with less than 128 characters. In this case, the SME starts the next cycle earlier.  
 – :REFL25:FCONtent can also be changed with ReFLEX25 being active.  
 – For using the frame types BER and FPAT, see also section „Bit Error Rate Test“ in the manual operation part.

Example: SOUR:REFL25:FCON "SAAAA...." RST value is "SAAAA..."(abbreviated)

**[:SOURce]:REFLex25:AADaptation** ON | OFF

If :REFL25:AADaptation is set to ON, the following settings are performed automatically as soon as ReFLEX25 is switched on:

:REFL25:SI:FCH:BASE, :REFL25:SI:FCH:ANUMber and :REFL25:SI:FSPacing are used to calculate and set the RF.

The values set automatically can be changed subsequently without recalculation of the telegram. These modifications take effect immediately. However, they do not react on the output parameters (:REFL25:SI:FCH:SCIBase etc., see above).

Example: SOUR:REFL25:AAD ON \*RST value is ON

**[:SOURce]:REFLex25:TACTion** MESSage | START | ONCE

This command (Trigger ACTion) determines the action triggered by a trigger event. The valid trigger events (free-running, external signal, \*TRG etc.) are specified by the command TRIGger:DM:SOURce. The assignment manual operation/remote control is also described with this command.

**MESSAge** A valid trigger event causes the next ALPH, NUM or TONE frame (see :REFL25:FCONtent) to be actually output as such and not as IDLE frame.

**START** The output of the ReFLEX telegram is only started by a valid trigger event. Then the frames are sent exactly as specified in :REFL25:FCONtent until :REFL25:STATe is switched to OFF. This setting is suitable for starting several SMEs synchronously.

**ONCE** The output of the ReFLEX telegram is only started by a valid trigger event. After recognition of this signal, exactly one cycle (up to 128 frames) is output. The frames are output exactly as specified in REFL25:FCONT. After execution of the cycle, the SME waits for its trigger pulse again (defined under TRIG:DM:SOUR).

Example: SOUR:REFL25:TACT MESS \*RST value is MESS

### 3.6.11.19 SOURce:ROSCillator Subsystem

This subsystem contains the commands to set the external and internal reference oscillator.

Command	Parameter	Default Unit	Remark
[:SOURce] :ROSCillator :EXTernal :FREQuency [:INTernal] :ADJust [:STATe] :VALue :SOURce	1 to 16 MHz  ON   OFF 0 to 4095 INTernal   EXTernal	Hz	

#### [:SOURce]:ROSCillator:EXTernal

The commands to set the external reference oscillator are under this node.

#### [:SOURce]:ROSCillator:EXTernal:FREQuency 1 to 16 MHz

The command informs the instrument about at which frequency the external reference oscillator oscillates.

Example: `:SOUR:ROSC:FREQ 5MHz` \*RST value is 10 MHz

#### [:SOURce]:ROSCillator[:INTernal]:ADJust

The commands for frequency correction (fine adjustment of the frequency) are under this node.

#### [:SOURce]:ROSCillator[:INTernal]:ADJust[:STATe] ON | OFF

The command switches the fine adjustment of the frequency on or off.

Example: `:SOUR:ROSC:INT:ADJ:STAT ON` \*RST value is OFF

#### [:SOURce]:ROSCillator[:INTernal]:ADJust:VALue 0 to 4095

The command indicates the frequency correction value (tuning value). For a detailed definition, cf. Chapter 2, Section Reference Frequency Internal/External.

Example: `:SOUR:ROSC:INT:ADJ:VAL 2048` \*RST value is 2048

#### [:SOURce]:ROSCillator:SOURce INTernal | EXTernal

The command selects the reference source.

INTernal The internal oscillator is used.

EXTernal The reference signal is fed externally.

Example: `:SOUR:ROSC:SOUR EXT`

\*RST value is INTernal

### 3.6.11.20 SOURce:STEReo Subsystem

This subsystem contains the commands to generate FM stereo multiplex signals conforming to standards according to the pilot-tone method (options SM-B5 and SM-B6). The modulation signal is output in addition at the LF output socket (cf. Section "OUTPut2 system" as well).

Command	Parameter	Default Unit	Remark
[:SOURce] :STEReo			Option SM-B6 and SM-B5
:STATe	ON   OFF		
[:DEViation]	0 Hz to 100 kHz	Hz	
:SIGNal	AUDio   ARI		
:AUDio			
[:FREQuency]	0.1 Hz to 15 kHz	Hz	
:PREemphasis	OFF   50 us   75 us		
:MODE	RIGHT   LEFT   RELeft   REMLeft		
:PILot			
:STATe	ON   OFF		
[:DEViation]	0 Hz to 10 kHz	Hz	
:PHASe	0 to 360 deg	rad	
:ARI			
[:DEViation]	0 Hz to 10 kHz		
:TYPE	BK   DK   OFF	Hz	
:BK			
[:CODE]	A   B   C   D   E   F		

**[:SOURce]:STEReo:STATe** ON | OFF

The command switches on or off the stereo signal.

\*RST value is OFF

Example: :SOUR:STER:STAT ON

**[:SOURce]:STEReo[:DEViation]** 0 Hz to 100 kHz

The command sets the frequency deviation of the FM stereo multiplex signal without considering the pilot-tone content.

Example: :SOUR:STER:DEV 40kHz

\*RST value is 40 kHz

**[:SOURce]:STEReo:SIGNal** AUDio | ARI

The command selects which signals are generated, simulated audio signals or ARI traffic channel signals with a 19-kHz pilot tone.

AUDio Audio signals are generated, ARI is switched off.

ARI ARI signals are generated.

Example: :SOUR:STER:SIGN AUD

\*RST value is AUDio

**[[:SOURce]:STEReo:AUDio]**

The commands to set the characteristics of the audio signals generated by the SME are under this node.

**[[:SOURce]:STEReo:AUDio[:FREQUENCY]]** 0.1 Hz to 15 kHz

The command sets the frequency of the audio signal. The frequency applies to both channels at the same time.

Example: `:SOUR:STER:AUD 1kHz` \*RST value is 1 kHz

**[[:SOURce]:STEReo:AUDio:PREEmphasis]** OFF | 50 us | 75 us

The command selects the preemphasis of the audio signal.

OFF Preemphasis is switched off.

50 us 0  $\mu$ s preemphasis

75 us 75  $\mu$ s preemphasis \*RST value is OFF

Example: `:SOUR:STER:AUD:PRE 50us`

**[[:SOURce]:STEReo:AUDio:MODE]** RIGHT | LEFT | RELeft | REMLeft

The command selects the operating mode in which the two channels operate.

RIGHT Audio signal only in the right channel

LEFT Audio signal only in the left channel

RELeft (Right Equals Left) Audio signals of same frequency and phase in both channels

REMLeft (Right Equals Minus Left) Audio signals of same frequency but opposite phase in both channels.

Example: `:SOUR:STER:AUD:MODE RIGH` \*RST value is RELeft

**[[:SOURce]:STEReo:PILot]**

The commands to set the characteristics of the 19-kHz pilot-tone signal are under this node.

**[[:SOURce]:STEReo:PILot:STATE]** ON | OFF

The command activates or deactivates the pilot tone. The pilot tone can be activated or deactivated independently of the setting of `SOURce:STEReo:SIGNal`.

Example: `:SOUR:STER:PIL:STAT ON` \*RST value is OFF

**[[:SOURce]:STEReo:PILot[:DEViation]]** 0 Hz to 10 kHz

The command sets the frequency deviation of the pilot tone. \*RST value is 6,72 kHz

Example: `:SOUR:STER:PIL:DEV 6720`

**[[:SOURce]:STEReo:PILot:PHASe]** 0 to 360 deg

The command sets the phase of the pilot tone. The zero crossing of the suppressed 38-kHz auxiliary carrier of the stereo multiplex signal serves as a phase reference.

Example: `:SOUR:STER:PIL:PHAS 10deg` \*RST value is 0 deg

**[[:SOURCE]:STEReo:ARI**

The commands to specify the characteristics of the ARI traffic channel signal are under this node.

**[[:SOURCE]:STEReo:ARI[:DEVIATION] 0 Hz to 10 kHz**

The command sets the deviation content of the unmodulated 57-kHz ARI auxiliary carrier.

Example: `:SOUR:STER:ARI:DEV 4kHz` \*RST value is 4 kHz

**[[:SOURCE]:STEReo:ARI:TYPE BK | DK | OFF**

The command specifies which identification is generated.

**BK** Area code. The AM modulation depth of the area code on the ARI auxiliary carrier, which has been selected under `SOURCE:STEReo:ARI:BK:CODE` is  $m = 0.6$ .

**DK** Broadcasting code. The AM modulation depth of the broadcasting code (125 Hz) on the ARI auxiliary carrier is  $m = 0.3$ .

**OFF** Area and broadcasting code are deactivated. \*RST value is DK

Example: `:SOUR:STER:ARI:TYPE BK`

**[[:SOURCE]:STEReo:ARI:BK**

The commands to specify the characteristics of the BK signal are under this node.

**[[:SOURCE]:STEReo:ARI:BK[:CODE] A | B | C | D | E | F**

The command specifies the area code.

**A** Traffic area code A 23,7500 Hz

**B** Traffic area code B 28,2738 Hz

**C** Traffic area code C 34,9265 Hz

**D** Traffic area code D 39,5833 Hz

**E** Traffic area code E 45,6731 Hz

**F** Traffic area code F 53,9773 Hz

\*RST value is A

Example: `:SOUR:STER:ARI:BK A`

### 3.6.11.21 SOURce:SWEep Subsystem

This subsystem contains the commands to check the RF sweep, i.e., sweeps of the RF generators. Sweeps are triggered on principle. The frequency sweep is activated by command `SOURce:FREQuency:MODE SWEep`, the level sweep by command `SOURce:POWer:MODE SWEep`.

Command	Parameter	Default Unit	Remark
<b>[[:SOURce]</b>			
<b>:SWEep</b>			
<b>:BTIMe</b>	NORMAl   LONG		
<b>[[:FREQuency]</b>			
<b>:DWELI</b>	10 ms to 5 s	s	
<b>:MODE</b>	AUTO   MANUal   STEP		
<b>:POINts</b>	Number		
<b>:SPACing</b>	LINear   LOGarithmic		
<b>:STEP</b>			
<b>[[:LINear]</b>	0 to 1 GHz	Hz	
<b>:LOGarithmic</b>	0.01 to 50 PCT	PCT	
<b>:POWer</b>			
<b>:DWELI</b>	10 ms to 5 s	s	
<b>:MODE</b>	AUTO   MANUal   STEP		
<b>:POINts</b>	Number		
<b>:STEP</b>			
<b>:LOGarithmic</b>	0 to 10 dB	dB	

#### **[[:SOURce]:SWEep:BTIMe** NORMAl | LONG

The command sets the blank time

(Blank TIMe) of the sweep. The setting is valid for all sweeps, i.e., also for LF sweeps.

NORMAl   Blank time as short as possible.

LONG      Blank time long enough to permit an XY recorder to return to 0.

Example:   : SOUR : SWE : BTIM LONG

\*RST value is NORM

#### **[[:SOURce]:SWEep[:FREQuency]**

The commands to set the frequency sweeps are under this node. Keyword [ :FREQuency ] can be omitted (cf. examples). The commands are SCPI compatible then unless stated otherwise.

#### **[[:SOURce]:SWEep[:FREQuency]:DWELI** 10 ms to 5 s

The command sets the dwell time per frequency step.

Example:   : SOUR : SWE : DWEL 12ms

\*RST value is 15 ms

**[:SOURce]:SWEep[:FREQUency]:MODE** AUTO | MANual | STEP

The command specifies the run of the sweep.

AUTO Each trigger triggers exactly one entire sweep cycle.

MANual Each frequency step of the sweep is triggered by means of manual control or a SOURce:FREQUency:MANual command, the trigger system is not active. The frequency increases or decreases (depending on the direction of the shaft encoder) by the value indicated under [:SOURce]:FREQUency:STEP:INCRement.

STEP Each trigger triggers only one sweep step (single-step mode). The frequency increases by the value indicated under [:SOURce]:SWEep:STEP:LOGarithmic.

Example: :SOUR:SWE:MODE AUTO \*RST value is AUTO

**[:SOURce]:SWEep[:FREQUency]:POINTs** Number

The command determines the number of steps in a sweep.

Instead of this command, commands SOURce:SWEep:FREQUency:STEP:LINear and SOURce:SWEep:FREQUency:STEP:LOGarithmic should be used, as SOURce:SWEep:FREQUency:POINTs has been adapted to the instrument characteristics in comparison to the SCPI command.

The value of POINTs depends on SPAN and STEP according to the following formulas..

The following is true for linear sweeps :  $POINTs = SPAN / STEP:LIN + 1$

The following is true for logarithmic sweeps and START < STOP:

$POINTs = ((\log STOP - \log START) / \log (1 + STEP:LOG))$

Two independent POINTs values are used for SPACing LOG and SPACing LIN. I.e., before POINTs is changed, SPACing must be set correctly. A change of POINTs results in an adaptation of STEP, but not of START, STOP and SPAN.

Example: :SOUR:SWE:POIN 100

**:SOURce2:SWEep[:FREQUency]:SPACing** LINear | LOGarithmic

The command selects whether the steps have linear or logarithmic spacings.

Example: :SOUR2:SWE:SPAC LIN \*RST value is LINear

**[:SOURce]:SWEep[:FREQUency]:STEP[:LINear]** 0 to 1 GHz

The command sets the step width with the linear sweep. If STEP[:LINear] is changed, the value of POINTs valid for SPACing:LINear also changes according to the formula stated under POINTs. A change of SPAN does not result in a change of STEP[:LINear]. Keyword [:LINear] can be omitted, then the command conforms to SCPI regulations (see example).

Example: :SOUR:SWE:STEP 1MHz \*RST value is 1 MHz

**[:SOURce]:SWEep[:FREQUency]:STEP:LOGarithmic** 0.01 to 50 PCT

The command indicates the step width factor for logarithmic sweeps. The next frequency value of a sweep is calculated according to

new frequency = prior frequency + STEP:LOG x prior frequency (if START < STOP)

STEP:LOG indicates the fraction of the prior frequency by which this is increased for the next sweep step. Usually STEP:LOG is indicated in percent, with the suffix PCT having to be used explicitly. If STEP:LOG is changed, the value of POINTs valid for SPAC:LOG also changes according to the formula stated under POINTs. A change of START or STOP does not result in a change of STEP:LOG.

Example: :SOUR:SWE:STEP:LOG 10PCT \*RST value is 1 PCT



**[[:SOURce]:SWEep:POWer:DWELI 10 ms to 5 s**

The command sets the dwell time per level step.

Example: :SOUR:SWE:POW:DWEL 12ms

\*RST value is 15 ms

**[[:SOURce]:SWEep:POWer:MODE AUTO | MANual | STEP**

The command specifies the run of the sweep.

AUTO Each trigger triggers exactly one entire sweep cycle.

MANual Each level step of the sweep is triggered by means of manual control or a :SOURce:POWer:MANual command, the trigger system is not active. The level increases or decreases (depending on the direction of the shaft encoder) by the value stated under :SOURce:POWer:STEP: INCRement.

STEP Each trigger triggers only one sweep step (single-step mode). The level increases by the value indicated under :SOURce:POWer:STEP: INCRement.

Example: :SOUR:SWE:POW:MODE AUTO

\*RST value is AUTO

**[[:SOURce]:SWEep:POWer:POINts Number**

The command determines the number of steps in a sweep. Instead of this command, command :SOURce:SWEep:POWer:STEP:LOGarithmic should be used, as POINts has been adapted to the instrument characteristics in comparison to the SCPI command.

The value of :POINts depends on .SPAN and :STEP according to the following formulas:

$$\text{POINts} = ((\log \text{STOP} - \log \text{START}) / \log \text{STEP:LOG}) + 1$$

A change of POINts results in an adaptation of STEP but not of START, STOP and SPAN.

Example: :SOUR:SWE:POW:POIN 100

**[[:SOURce]:SWEep:POWer:STEP:LOGarithmic 0 to 10 dB**

The command indicates the step width factor for logarithmic sweeps. The next level value of a sweep is calculated according to

new level = prior level + STEP:LOG × prior level

STEP:LOG indicates the fraction of the prior level by which this is increased for the next sweep step. Usually STEP:LOG is indicated in dB, with suffix dB having to be used explicitly. If STEP:LOG is changed, the value of POINts also changes according to the formula indicated under POINts. A change of START or STOP does not result in a change of STEP:LOG. Keyword :LOG can be omitted, then the command conforms to SCPI regulation (see example).

Example: :SOUR:SWE:STEP 10dB

\*RST value is 1dB

### 3.6.11.22 SOURce:VOR Subsystem

This subsystem contains the commands to control the characteristics of the test signals for VOR (VHF Omnidirectional Range) (option SM-B6, multifunction generator).

Command	Parameter	Default Unit	Remark
[:SOURce]			
:VOR			Option SM-B6
:STATe	ON   OFF		
:SOURce	INT2   INT2, EXT		
:MODE	NORM   VAR   SUBCarrier   FMSubcarrier		
[:BANGLE]	0 to 360 deg	rad	
:DIRection	FROM   TO		
:VAR			
[:DEPTh]	0 to 100 PCT	PCT	
:FREQuency	20 to 40 Hz	Hz	
:SUBCarrier			
:DEPTh	0 to 100 PCT	PCT	
[:FREQuency]	5 to 15 kHz	Hz	
:REFerence			
[:DEViation]	0 to 960 Hz	Hz	
:PRESet			No query
:COMid			
[:STATe]	ON   OFF		
:FREQuency	0.1 to 20 000 Hz	Hz	
:DEPTh	0 to 100 PCT	PCT	

**[:SOURce]:VOR:STATe ON | OFF**

The command switches on or off the generation of VOR signals. STATe ON is only possible if no amplitude modulation is switched on. Modulation generator 2 must not be switched simultaneously as a source for PM or FM either. \*RST value is OFF

Example:   : SOUR:VOR:STAT ON

**[:SOURce]:VOR:SOURce INT2 | INT2, EXT**

This command determines the signal sources of the test signal.

INT2           The test signal used for VOR is generated internally by LF generator 2 (SOURce INT2).

INT2 , EXT    A signal from input EXT1 is added to the internal signal in addition. Switching off the internal source is not possible. \*RST value is INT2

Example:   : SOUR:VOR:SOUR INT2

**[[:SOURCE]:VOR:MODE NORM | VAR | SUBCarrier**

The command specifies the type of VOR signal generated.

**NORM** VOR signal

**VAR** Amplitude modulation of the output signal with the SOURCE:VOR:VAR:FREQUENCY signal component (usually 30 Hz) of the VOR signal. The modulation depth is set under SOURCE:VOR:VAR:DEPTH.

**SUBCarrier** Amplitude modulation of the output signal with the unmodulated SOURCE:VOR:SUBCarrier:FREQUENCY-FM carrier (usually 9960 Hz) of the VOR signal. The modulation depth is set under SOURCE:VOR:SUBCarrier:DEPTH.

**FMSubcarrier (FM-modulated subcarrier)** Amplitude modulation of the output signal with the frequency-modulated SOURCE:VOR:SUBCarrier:FREQUENCY FM carrier (usually 9960 Hz) of the VOR signal. The frequency deviation is set under SOURCE:VOR:REFERENCE:DEVIATION, the modulation depth under SOURCE:VOR:SUBCarrier:DEPTH. \*RST value is NORM

Example: :SOUR:VOR:MODE VAR

**[[:SOURCE]:VOR[:BANGLE] 0 to 360 deg**

The command sets the Bearing ANGLE between the VAR signal and the reference signal. The orientation of the angle depends on the setting under SOURCE:VOR:BANGLE:DIRECTION.

Example: :SOUR:VOR:BANG 0deg \*RST value is 0 Grad

**[[:SOURCE]:VOR[:BANGLE]:DIRECTION FROM | TO**

The command determines the orientation of the bearing angle.

**FROM** The bearing angle is measured between the geographic north and the connection line from beacon to airplane.

**TO** The bearing angle is measured between the geographic north and the connection line from airplane to beacon.

Example: :SOUR:VOR:BANG:DIR TO \*RST value is FROM

**[[:SOURCE]:VOR:VAR[:DEPTH] 0 to 100 PCT**

The command sets the AM modulation depth of the VAR signal.

Example: :SOUR:VOR:VAR:DEPT 30PCT \*RST value is 30PCT

**[[:SOURCE]:VOR:VAR:FREQUENCY 20 to 40 Hz**

The command sets the frequency of the VAR signal. As VAR and reference signal must always have the same frequency, this setting is also valid for the reference signal.

Example: :SOUR:VOR:VAR:FREQ 30 \*RST value is 30 Hz

**[[:SOURCE]:VOR:SUBCarrier:DEPTH 0 to 100 PCT**

The command sets the AM modulation depth of the FM carrier.

\*RST value is 30PCT

Example: :SOUR:VOR:SUBC:DEPT 30PCT

**[[:SOURCE]:VOR:SUBCarrier:FREQUENCY 5 to 15 kHz**

The command sets the frequency of the FM carrier.

\*RST value is 9960 Hz

Example: :SOUR:VOR:SUBC:FREQ 9960

**[[:SOURce]:VOR:REFerence[:DEViation] 0 to 960 Hz**

The command sets the frequency deviation of the reference signal on the FM carrier.

Example: :SOUR:VOR:REF:DEV 480 \*RST value is 480 Hz

**[[:SOURce]:VOR:PRESet**

The command sets the frequency deviation of the reference signal on the FM carrier.

```
:VOR:MODE NORM
:VOR:SOUR INT2
:VOR 0deg
:VOR:DIRection FROM
:VOR:VAR:FREQ 30Hz
:VOR:VAR 30PCT
:VOR:SUBC 9960Hz
:VOR:SUBC:DEPTh 30PCT
:VOR:REF:DEV 480Hz
:VOR:COM OFF
:VOR:COM:FREQ 1020Hz
:VOR:COM:DEPTh 10PCT
```

The values set correspond to the state after SYSTEM:PRESET or \*RST. The command neither has a query form nor an \*RST value.

Example: :SOUR:VOR:PRES

**[[:SOURce]:VOR:COMid[:STATe] ON | OFF**

The command activates or deactivates the ComId signal.

\*RST value is OFF

Example: :SOUR:VOR:COM:STAT ON

**[[:SOURce]:VOR:COMid:FREQuency 0.1 to 20 000 Hz**

The command sets the frequency of the ComId signal.

\*RST value is 1020 Hz

Example: :SOUR:VOR:COM:FREQ 1020

**[[:SOURce]:VOR:COMid:DEPTh 0 to 100 PCT**

The command sets the AM modulation depth of the ComId signal.

Example: :SOUR:VOR:COM:DEPT 10PCT

\*RST value is 10 PCT

### 3.6.12 SOURce0|2 System

The SOURce0|2 system contains the commands to configure the LF signal sources. The following allocation is valid:

- SOURce0:** Standard generator.  
Designated as INT1 if used as a modulation source (cf. command SOURce:AM:SOURce INT1, e.g.). The numbering as SOURce0 is different from the manual control.  
Second optional LF generator (option SM-B2).  
Replaces the standard generator which is cut out by this option. Is designated as INT1 if it is used as a modulation source; if it is used as an LF generator, it is designated as SOURce0 differently from the numbering of the manual control.
- SOURce2:** First optional LF or modulation generator (option SM-B2 or SM-B6).  
Is designated as INT2 if it is used as a modulation source; if it is used as an LF generator, it is designated as SOURce2.

The commands to set the output voltage of the LF generators are in the OUTPut2 system (see Section 3.6.10)

Subsystems	Settings
<b>: SOURce0   2</b> <b>:FREQUency</b> <b>:FUNCTion</b> <b>:MARKer</b> <b>:SWEep</b>	Frequency with CW and sweep operation. Waveform of the output signal Marker for LF sweeps (only possible using SOURce2) LF sweep (only possible using SOURce2)

#### 3.6.12.1 SOURce0|2:FREQUENCY Subsystem

This subsystem contains the commands for the frequency settings in operating modes CW and SWEep. Only command SOURce0:FREQUency:CW|FIXed is effective for the standard LF generator (SOURce0). For LF generator2 (SOURce2), sweep commands are effective as well.

Command	Parameter	Default Unit	Remark
<b>: SOURce0   2</b> <b>:FREQUency</b> <b>[:CW :FIXed]</b> <b>:MANual</b> <b>:MODE</b> <b>:START</b> <b>:STOP</b>	400 Hz   1 kHz   3 kHz   15 kHz or 0.1 Hz to 500 kHz or 0.1 Hz to 1 MHz 0.1 Hz to 500 kHz or 0.1 Hz to 1 MHz CW FIXed   SWEep 0.1 Hz to 500 kHz or 0.1 Hz to 1 MHz 0.1 Hz to 500 kHz or 0.1 Hz to 1 MHz	Hz Hz Hz Hz	Option SM-B2 or B6 Option SM-B2 or B6 Option SM-B2 or B6 Option SM-B2 or B6

**:SOURce0|2:FREQUENCY[:CW | :FIXed]** 400 Hz | 1 kHz | 3 kHz | 15 kHz or 0.1 Hz to 500 kHz or 0.1 Hz to 1 MHz

The command sets the frequency for the CW mode.

If neither SM-B2 nor SM-B6 are fitted, the values 400 Hz, 1 kHz, 3 kHz and 15 kHz are permissible for SOURce0. With option SM-B2, values from 0.1 Hz to 500 kHz are permissible, with SM-B6 from 0.1 Hz to 1 MHz. RST-Wert is 1 kHz

Example: :SOUR2:FREQ: CW 1kHz

**SOURce0|2:FREQUENCY:MANual** 0.1 Hz to 500 kHz or 0.1 Hz to 1 MHz

The command sets the frequency if SOURce2:SWEep:MODE MANual and SOURce2:FREQUENCY: MODE SWEep are set. In this case, only frequency values between the settings SOURce2: FREQUENCY:START and to :STOP are allowed.

Example: :SOUR2:FREQ:MAN 1kHz \*RST value is 1kHz

**SOURce0|2:FREQUENCY:MODE** CW|FIXed | SWEep

The command specifies the operating mode and hence by means of which commands the FREQUENCY subsystem is checked. The following allocations are valid:

**CW |FIXed** CW and FIXed are synonyms. The output frequency is specified by means of SOURce0|2:FREQUENCY: CW |FIXed.

**SWEep** The generator operates in the SWEep mode. The frequency is specified by means of commands SOURce2:FREQUENCY:START; STOP; MANual. The SWEep setting is only possible for SOURce2-

Example: :SOUR2:FREQ:MODE CW \*RST value is CW

**SOURce0|2:FREQUENCY:START** 0.1 Hz to 500 kHz or 0.1 Hz to 1 MHz

This command indicates the starting value of the frequency for the sweep.

Example: :SOUR2:FREQ:STAR 100kHz \*RST value is 1kHz

**SOURce0|2:FREQUENCY:STOP** 0.1 Hz to 500 kHz or 0.1 Hz to 1 MHz

This command indicates the end value of the frequency for the sweep.

Example: :SOUR2:FREQ:STOP 200kHz \*RST value is 100 kHz

### 3.6.12.2 SOURce 0|2:FUNCTION-Subsystem

This subsystem contains the commands specifying the waveform of the output signal.

Command	Parameter	Default Unit	Remark
:SOURce0 2 :FUNCTION [:SHAPE]	SINusoid   SQUare   TRIangle   PRNoise   SAWTooth		Option SM-B2 / B6 Option SM-B6

**:SOURce0|2:FUNCTION[:SHAPE]** SINusoid | SQUare | TRIangle | PRNoise | SAWTooth

The command specifies the waveform of the output signal. In the case of the standard generator, the waveform is specified to be sine. Option SM-B2, LF generator can be converted to the signal forms sine, square, triangle and periodic noise, option SM-B6, multifunction generator to all signal forms. If two options SM-B2 are installed, SOURce0 can be set to the signal forms of option SM-B2 as well.

SINusoid      Sine

SQUare        Square

TRIangle      Triangle

PRNoise       Periodic noise

SAWtooth     Sawtooth

\*RST value is SIN

Example:      :SOUR2:FUNC:SHAP SQU

**3.6.12.3 SOURce2:MARKer-Subsystem**

This subsystem contains the commands to check the marker generation in the case of LF sweeps. Operating mode SWEEP is only possible for SOURce2. The three markers existing are differentiated by a numeric suffix after marker.

Command	Parameter	Default Unit	Remark
<b>:SOURce2</b> <b>:MARKer 1   2   3</b> <b>[:FSWweep]</b> <b>:AOFF</b> <b>:FREquency</b> <b>[:STATe]</b> <b>:POLarity</b>	0.1 Hz to 500 kHz ON   OFF NORMal   INVerted	Hz	Option SM-B2/B6  No query

**:SOURce2:MARKer 1 | 2 | 3[:FSWweep]**

The commands for the markers with the LF frequency sweep (Frequency SWEEP) are under this node. Keyword [:FSWweep] can also be omitted, then the command conforms to SCPI regulation (see examples).

**:SOURce2:MARKer1|2|3[:FSWweep]:AOFF**

The command switches off all LF frequency markers. This command triggers an event, thus is has no \*RST value and no query form.

Example: :SOUR2:MARK:AOFF

**:SOURce2:MARKer1|2|3[:FSWweep]:FREquency** 0.1 Hz to 500 kHz

The command sets the marker selected by the numeric suffix at MARKer to the frequency indicated.

\*RST value for MARK1: 100kHz  
 MARK2: 10kHz  
 MARK3: 1kHz

Example: :SOUR2:MARK1:FREQ 9000

**:SOURce2:MARKer1|2|3[:FSWweep][:STATe]** ON | OFF

The command switches on or off the marker selected by the numeric suffix at MARKer.

Example: :SOUR2:MARK1:STAT ON \*RST value is OFF

**:SOURce2:MARKer1|2|3:POLarity** NORMal | INVerted

The command specifies the polarity of the marker signal as follows:

NORMal When running through the marker condition, TTL level is applied at the marker output, otherwise 0 V.

INVers When running through the marker condition, 0 V is applied at the marker output, otherwise TTL level. \*RST value is NORM

Example: :SOUR2:MARK1:POL INV



### 3.6.12.4 SOURce2:SWEep-Subsystem

This subsystem contains the commands to check the LF sweep of SOURce2. Sweeps are triggered on principle.

Command	Parameter	Default Unit	Remark
:SOURce2			Option SM-B2
:SWEep			
:BTIMe	NORMal   LONG		
[:FREQuency]			
:DWELI	1 ms to 1 s	s	
:MODE	AUTO   MANual   STEP		
:POINts	Number		
:SPACing	LINear   LOGarithmic		
:STEP			
[:LINear]	0 to 500 kHz	Hz	
:LOGarithmic	0.01 PCT to 50 PCT	PCT	

#### :SOURce2:SWEep:BTIMe NORMal | LONG

The command sets the blank time (Blank TIMe) of the sweep. The setting is valid for all sweeps, i.e., also for RF sweeps

NORMal Blank time as short as possible.

LONG Blank time long enough to permit an X/Y recorder to return to 0.

Example: :SOUR2:SWE:BTIM LONG \*RST value is NORM

#### :SOURce2:SWEep

The commands to set the frequency sweeps are under this node. Keyword [:FREQuency] can be omitted. Then the commands are SCPI-compatible unless stated otherwise (see examples).

#### :SOURce2:SWEep[:FREQuency]:DWELI 1 ms to 1 s

The command sets the time per frequency step (dwell).

Example: :SOUR2:SWE:DWEL 20ms \*RST value is 15 ms

#### :SOURce2:SWEep[:FREQuency]:MODE AUTO | MANual | STEP

The command specifies the run of the sweep.

AUTO Each trigger triggers exactly one entire sweep cycle.

STEP Each trigger triggers only one sweep step (single-step mode). The frequency increases by the value indicated under :SOURce2:SWEep

Example: :SOUR2:SWE:MODE AUTO \*RST value is AUTO

**:SOURce2:SWEep[:FREQUENCY]:POINTS** Number

The command determines the number of steps in a sweep. Instead of this command, commands :SOURce2:FREQUENCY:STEP:LINEar and :SOURce2 :FREQUENCY:STEP:LOGarithmic should be used, as :SOURce2:SWEep:FREQUENCY: POINTs has been adapted to the instrument characteristics in comparison to the SCPI command. The value of POINTs depends on SPAN and STEP according to the following formulas.

The following is true of linear sweeps :  $POINTS = SPAN / STEP:LIN + 1$

The following is true of logarithmic sweeps and START < STOP:

$$POINTS = ((\log STOP \log START) / \log STEP:LOG) + 1$$

Two independent POINTs values are used for SPACing LOG and SPACing LIN. That is to say, before POINTs is changed, SPACing must be set correctly. A change of POINTs causes an adaption of STEP, but not of START, STOP and SPAN.

Example: :SOUR2:SWE:POIN 50

**:SOURce2:SWEep[:FREQUENCY]:SPACing** LINEar | LOGarithmic

The command selects whether the steps have linear or logarithmic spacings.

Example: :SOUR2:SWE:SPAC LOG \*RST value is LINEar

**:SOURce2:SWEep[:FREQUENCY]:STEP**

The commands to set the step width with linear and logarithmic sweeps are under this node. The settings of STEP:LIN and STEP:LOG are independent of each other.

**:SOURce2:SWEep[:FREQUENCY]:STEP[:LINEar]** 0 to 500 kHz

The command sets the step width with the linear sweep. If STEP:LINEar is changed, the value of POINTs valid for SPACing:LINEar also changes according to the formula indicated under POINTs. A change of SPAN does not cause a change of STEP:LINEar. Keyword [:LINEar] can be omitted, then the command conforms to SCPI regulation (see example)

Example: :SOUR2:SWE:STEP 10kHz \*RST value is 1 kHz

**:SOURce2:SWEep[:FREQUENCY]:STEP:LOGarithmic** 0.01 to 50PCT

The command indicates the step width factor for logarithmic sweeps. The next frequency value of a sweep is calculated according to (if START < STOP) :

$$\text{new frequency} = \text{prior frequency} + \text{STEP:LOG} \times \text{prior frequency}$$

Thus STEP:LOG indicates the fraction of the prior frequency by which this is increased for the next sweep step. Usually STEP:LOG is indicated in percent, with the suffix PCT having to be used explicitly. If STEP:LOG is changed, the value of POINTs valid for SPACing:LOGarithmic also changes according to the formula stated unde

Example: :SOUR2:SWE:STEP:LOG 5PCT \*RST value is 1 PCT





### 3.6.14 SYSTem-System

In this system, a number of commands for general functions which are not immediately related to signal generation, are combined.

Command	Parameter	Default Unit	Remark
<b>:SYSTem</b>			
<b>:BEEPer</b>			
<b>:STATe</b>	ON   OFF		
<b>:COMMunicate</b>			
<b>:GPIB</b>			
<b>[:SELF]</b>			
<b>:ADDRess</b>	0 to 30		
<b>:SERial</b>			
<b>:CONTRol</b>	ON   IBFull   RFR		
<b>:RTS</b>	1200   2400   4800   9600   19200   38400   57600   115200		
<b>:BAUD</b>	XON   NONE		
<b>:PACE</b>			
<b>:ERRor?</b>	ON   OFF		Query only
<b>:KLOCK</b>	FIXed   MSEquence		
<b>:MODE</b>			
<b>:MSEquence</b>			
<b>:CATalog?</b>	"Name of sequence"		Query only
<b>:DELeTe</b>			
<b>:ALL</b>	50 ms to 60 s {,50 ms to 60 s}	s	
<b>:DWELI</b>			
<b>:FREE?</b>	AUTO   STEP		
<b>:MODE</b>	1 to 50 {,1 to 50}		
<b>[:RCL]</b>			
<b>:POINts?</b>	"Name of sequence"		Query only
<b>:SElect</b>			No query
<b>:PRESet</b>			
<b>:PROTect</b>	ON   OFF , password		
<b>[:STATe]</b>			
<b>:SECurity</b>	ON   OFF		
<b>[:STATe]</b>			Query only
<b>:SERRor?</b>			Query only
<b>:VERSion?</b>			Query only

**:SYSTem:BEEPer:STATe** ON | OFF

This node contains the commands to set the beeper fitted.

\*RST value is OFF

Example:       :SYST:BEEP:STAT OFF

**:SYSTem:COMMunicate**

The commands to set the remote control interfaces are under this node.

**:SYSTem:COMMunicate:GPIB**

The commands to check the IEC bus are under this node (GPIB = General Purpose Interface Bus)

**:SYSTem:COMMunicate:GPIB[:SELF]:ADDRess 1 to 30**

The command sets the IEC bus instrument address. \*RST value is 28

Example:       :SYST:COMM:GPIB:ADDR 1

**:SYSTem:COMMunicate:SERial**

The command to set the serial interface are under this node. The data format is fixedly set to 8 data bits, no parity and 1 stop bit. These values cannot be changed. The device represents a DTE (Data Terminal Equipment) in relation to the serial interface. Therefore the the controller must be connected via a 0-modem.

**:SYSTem:COMMunicate:SERial:BAUD 1200|2400|4800|9600|19200|38400|57600|115200**

The commands sets the baud rate for both the transmit and the receive direction. \*RST has no influence on this parameter.

Example:       :SYST:COMM:SER:BAUD 1200 \*RST value is 9600

**:SYSTem:COMMunicate:SERial:CONTrol:RTS ON | IBFull | RFR**

he commands sets the hardware handshake. \*RST has no influence on this parameter.

ON             Interface line RTS is always active.

IBFull | RFR   Input Buffer Full | Ready For Receiving.  
Interface line RTS remains active as long as the instrument is ready to receive data

Example:       :SYST:COMM:SER:CONT:RTS ON \*RST value is RFR

**:SYSTem:COMMunicate:SERial:PACE XON | NONE**

The command sets the software handshake. \*RST has no influence on this parameter.

XON            Software handshake using the ASCII codes 11h (XON) and 13h (XOFF).

**Note:** *This mode is not recommended for binary data and for baud rates above 9600 bauds.*

NONE           No software handshake.

Example:       :SYST:COMM:SER:PACE NONE \*RST value is NONE

**:SYSTem:ERRor?**

The command queries the entry that has been in the error queue for the longest time. Positive error numbers denote errors specific of the instrument, negative error numbers denote error messages specified by SCPI (see annex B). If the error queue is empty, 0, "No error", is returned. The command is identical to `STATUS:QUEUE:NEXT?`

Example:       :SYST:ERR?                               Response: -221, "Settings conflict"







**:SYSTem:PROTect1|2|3 [:STATe] ON | OFF, password**

The command switches a protection level on or off. The passwords are 6-digit numbers. They are fixedly stored in the firmware. The password for the first level is 123456.

ON disables the functions belonging to this protection level. A password need not be indicated.

OFF deactivates the disabling again if the correct password is indicated. Otherwise an error -224, "Illegal parameter value" is generated and STATe remains ON.

Example: :SYST:PROT1:STAT OFF, 123456

**:SYSTem:SECurity**

The commands setting the security characteristics of the instrument are under this node.

**:SYSTem:SECurity[:STATe] ON | OFF**

The command switches the security state on or off. The command is not influenced by \*RST and \*RCL.

ON The following commands cannot be executed:

```
:DISPlay:ANNotation:ALL ON
:DISPlay:ANNotation:FREQ ON
:DISPlay:ANNotation:AMPLitude ON
:SYSTem:KLOCK OFF
```

OFF In the transition from ON to OFF all data existing in the instrument except for the calibrating data are deleted, especially all status registers, all instrument states and all lists.

Example: :SYST:SEC:STAT ON

**:SYSTem:SERRor?**

This command returns a list of all errors existing at the point of time of the query. This list corresponds to the indication on the ERROR page with manual control (cf. Section Error Messages).

Example: :SYST:SERR?

Response: -221, "Settings conflict", 153, "Input voltage out of range"

**:SYSTem:VERSion?**

The command returns the SCPI version number the instrument acts in accordance with. This command is a query and thus has no \*RST value.

Example: :SYST:VERS?

Response: 1994.0

### 3.6.15 TEST-System

This system contains the commands to execute the selftest routines (RAM?, ROM? and BATTERY?) as well as to directly manipulate the hardware modules (:TEST:DIRect). The selftests return a "0" if the test has been executed successfully, otherwise a value unequal to "0". All commands of this system do not have an \*RST value.

**Caution:** *The commands under node :TEST:DIRect directly act on the respective hardware module circumventing any security mechanisms. They are provided for service purposes and should not be used by the user. Improper use of the commands may damage the module.*

Command	Parameter	Default Unit	Remark
<b>:TEST</b>			
<b>:DIRect</b>			
<b>:ATTC</b>	Subaddress, hex data string		
<b>:DCOD</b>	Subaddress, hex data string		
<b>:DSYN0MUX</b>	Subaddress, hex data string		
<b>:DSYN1MUX</b>	Subaddress, hex data string		
<b>:FMOD</b>	Subaddress, hex data string		
<b>:LFGENA</b>	Subaddress, hex data string		
<b>:LFGENB</b>	Subaddress, hex data string		
<b>:MGEN</b>	Subaddress, hex data string		
<b>:OPU1M</b>	Subaddress, hex data string		
<b>:OPU3M</b>	Subaddress, hex data string		
<b>:OPU6M</b>	Subaddress, hex data string		
<b>:PUM</b>	Subaddress, hex data string		
<b>:REFSS</b>	Subaddress, hex data string		
<b>:ROSC</b>	Subaddress, hex data string		
<b>:SUM</b>	Subaddress, hex data string		
<b>:RAM?</b>			Query only
<b>:ROM?</b>			Query only
<b>:BATTERY[:RAM]?</b>			Query only
<b>:BATTERY :XMEM?</b>			Query only

#### **:TEST:DIRect**

This node contains the commands directly acting on the respective hardware module circumventing any security mechanisms. The commands under this node have no short form.

#### **:TEST:DIRect:SUM** Subaddress, hex data string

The command directly acts on module SUM. A subaddress (0 or 1) must be indicated as a parameter. The data are indicated as a <string> (i.e., an ASCII character string enclosed in quotation marks) representing hexadecimal numbers. Thus characters 0 to 9 A to F may occur in the character string.

Example: `:TEST:DIR:SUM 0, "0010AF1F"`

Query: `:TEST:DIR:SUM? 0`

#### **:TEST:DIRect:ATTC** Subaddress, hex data string

The command acts on module ATTC. (cf. `:TEST:DIR:SUM`)

- :TEST:DIRect:DCOD** Subaddress, hex data string  
The command acts on module DCOD. (cf. :TEST:DIR:SUM)
- :TEST:DIRect:DSYN0MUX** Subaddress, hex data string  
The command acts on module DSYN. (cf. :TEST:DIR:SUM)
- :TEST:DIRect:DSYN1MUX** Subaddress, hex data string  
The command acts on module DSYN. (cf. :TEST:DIR:SUM)
- :TEST:DIRect:FMOD** Subaddress, hex data string  
The command acts on module FMOD. (cf. :TEST:DIR:SUM)
- :TEST:DIRect:LFGENA** Subaddress, hex data string  
The command acts on module LFGENA. (cf. :TEST:DIR:SUM)
- :TEST:DIRect:LFGENB** Subaddress, hex data string  
The command acts on module LFGENB. (cf. :TEST:DIR:SUM)
- :TEST:DIRect:MGEN** Subaddress, hex data string  
The command acts on module MGEN. (cf. :TEST:DIR:SUM)
- :TEST:DIRect:OPU1M** Subaddress, hex data string  
The command acts on module OPU1. (cf. :TEST:DIR:SUM)
- :TEST:DIRect:OPU3M** Subaddress, hex data string  
The command acts on module OPU3. (cf. :TEST:DIR:SUM)
- :TEST:DIRect:OPU6M** Subaddress, hex data string  
The command acts on module OPU6. (cf. :TEST:DIR:SUM)
- :TEST:DIRect:PUM** Subaddress, hex data string  
The command acts on module PUM. (cf. :TEST:DIR:SUM)
- :TEST:DIRect:REFSS** Subaddress, hex data string  
The command acts on module REFSS. (cf. :TEST:DIR:SUM)
- :TEST:DIRect:ROSC** Subaddress, hex data string  
The command acts on module ROSC. (cf. :TEST:DIR:SUM)
- :TEST:RAM?**  
The command triggers a test of the RAM.
- :TEST:ROM?**  
The command triggers a test of the main memory (EEPROM).
- :TEST:BATTery[:RAM]?**  
The command triggers a test of the RAM battery voltage. The voltage should be at least 2.1 V.
- :TEST:BATTery:XMEM?**  
The command triggers a test of the XMEM battery voltage. The voltage should be at least 2.1 V.

### 3.6.16 TRIGger-System

The TRIGger system contains the commands to select the trigger source and to configure the external trigger socket. The suffix is only important for the SWEEP subsystem and conforms to the numbering of the SOURce system:

TRIGger1 = RF generator

TRIGger2 = LFGEN2

The trigger system of the SME is a simplified implementation of the SCPI trigger system. Compared to SCPI, the TRIGger system shows the following differences:

- No INITiate command, the instrument behaves as if INITiate:CONTInuous ON was set.
- There are several subsystems denoting the different parts of the instrument under TRIGger (SWEep, LIST, PULSe, MSequence, DM).

Further commands as to the trigger system of the SME can be found in the ABORt system.

Command	Parameter	Default Unit	Remark
<b>:TRIGger1 2</b>			
<b>[:SWEep]</b>			
<b>[:IMMediate]</b>			No query
<b>:SOURce</b>	SINGle   EXTernal   AUTO		
<b>:DM</b>			Option SME-B11
<b>[:IMMediate]</b>			No query
<b>:SOURce</b>	SINGle   EXTernal   AUTO		
<b>:LIS</b>			
<b>[:IMMediate]</b>			No query
<b>:SOURce</b>	SINGle   EXTernal   AUTO		
<b>:MSequence</b>			
<b>[:IMMediate]</b>			No query
<b>:SOURce</b>	SINGle   EXTernal   AUTO		
<b>:PULSe</b>			
<b>:SOURce</b>	EXTernal   AUTO		
<b>:SLOPe</b>	POSitive   NEGative		
<b>:SLOPe</b>	POSitive   NEGative		

#### **:TRIGger1|2[:SWEep]**

All commands to trigger a sweep are under this node. The settings here act on level and frequency sweeps for RF generator (TRIG1) and LF generator (TRIG2).

#### **:TRIGger1|2[:SWEep][:IMMediate]**

The command immediately starts a sweep. Which sweep is executed depends on the respective MODE setting, e.g. :SOURce:FREQuency:MODE SWEEp. The command corresponds to manual-control command EXECUTE SINGLE SWEEP. This command triggers an event and thus has no \*RST value.

Example:       :TRIG:SWE:IMM

**:TRIGger1[2]:SWEep]:SOURce** AUTO | SINGle | EXTernal

The command specifies the trigger source. The naming of the parameters directly corresponds to the different settings with manual control. SCPI uses other designations for the parameters the instrument accepts as well. These designations are to be preferred if compatibility is important. The following table provides an overview.

SME designation	SCPI designation	Command with manual control
AUTO	IMMediate	MODE AUTO
SINGle	BUS	MODE SINGLE or STEP
EXTernal	EXTernal	MODE EXT TRIG SINGLE or EXT TRIG STEP

**AUTO** The trigger is free-running, i.e., the trigger requirement is permanently met. As soon as a sweep has been terminated, the next one is started.

**SINGle** Triggering is effected by means of IEC-bus commands `:TRIGger:SWEep:IMMediate` or `*TRG`. If `:SOURce:SWEep:MODE` is set to `STEP`, a step, in the case of the `AUTO` setting a complete sweep, is executed.

**EXTernal** Triggering is effected from outside via the `EXT.TRIG` socket or by the `GET` command via IEC/IEEE-bus (see annex A). The action triggered depends on the setting of the sweep mode as in the case of `SINGle`.

Example: `:TRIG:SWE:SOUR AUTO` \*RST value is `SINGle`

**:TRIGger:DM**

The commands for the autorun control of digital modulations are under this is node.

These commands are only valid for `TRIGger1`.

**:TRIGger:DM[:IMMediate]**

In case of basic digital modulations, this command immediately starts the processing of the data list of the DM data generator. The command acts on the type of modulation presently set using `SOURce:DM:TYPE`.

In case of complex digital modulations (`FLEX`, `ERMes`, `POCSag`), the command immediately triggers the action set using `TACTion` (`Trigger ACTION`, in the subsystem of the corresponding modulation).

It corresponds to the `EXECUTE SINGLE` command of the manual control in the associated `DIGITAL MOD` menu. This command is an event and thus has no \*RST value.

Example: `:TRIG:DM:IMM`

**:TRIGger:DM:SOURce** AUTO | SINGle | EXTernal

The command specifies the valid trigger events. See following table for effect on complex modulations

**AUTO** The trigger condition is always fulfilled. In case of basic digital modulations, the list is processed repeatedly, the RF signal is continuously DM-modulated.

**SINGle** The trigger condition can be fulfilled by manual control or by using the commands `TRIG:DM:IMM` or `*TRG`. The list is processed only once. DM is subsequently inactive.

**EXTernal** This setting has no effect on the basic digital modulations.

Effect of TRIGger:DM:SOURce and SOURce:ERMeS|FLEX|REFL25|POCSag:TACTion on the sequence of complex digital modulations.

:SOURce:ERM FLEX REFI25 POCS:TACTion			
TRIGger:DM:SOURce	MESSAge	STARt	ONCE
AUTO	MODE ALWAYS The frames are continuously repeated in the set sequence; the setting under ERMeS FLEX REFLeX25 POCSag:TACTion is irrelevant		
SINGle	MODE SINGLE A trigger event (key; IEC/IEEE-bus- command) switches once from IDLE frame output to ALPH-, NUM and TONE frame output.	—	—
EXT	MODE EXT-SINGLE An external trigger event (signal edge at the trigger connector) switches once from IDLE frame output to ALPH-, NUM and TONE frame output.	MODE EXTTRIG-ALWAYS An external trigger event starts digital modulation. Subsequently, the frames are continuously repeated in the set sequence.	MODE EXTTRIG An external trigger event starts the digital modulation. After the output of a cycle (FLEX/REFLeX25), a time slice (POCSAG) or a subsequence (ERMES) the modulation is stopped, the SME waits for the next trigger event.

Example: :TRIG:DM:SOUR AUTO

\*RST value is AUTO

**:TRIGger:LIST**

This node contains all commands to trigger a list in the LIST mode.

The commands are only valid for TRIGger1.

**:TRIGger:LIST[:IMMediate]**

The command immediately starts the processing of a list of the LIST mode. It corresponds to command EXECUTE SINGLE MODE of the manual control in the LIST menu. This command is an event and thus has no \*RST value.

Example: :TRIG:LIS:IMM

**:TRIGger1|2:LIST:SOURce** AUTO | SINGle | EXTernal

The command specifies the trigger source. The naming of the parameters corresponds to the one with sweep mode. SCPI uses other designations for the parameters the instrument accepts as well. These designations are to be preferred if compatibility is important. The following table provides an overview:

SME designation	SCPI designation	Command with manual control
AUTO	IMMediate	MODE AUTO
SINGle	BUS	MODE SINGLE or STEP
EXTernal	EXTernal	MODE EXT TRIG SINGLE or EXT TRIG STEP

**AUTO** The trigger is free-running, i.e., the trigger condition is permanently fulfilled. As soon as the list selected has been finished in the LIST mode, it is started anew.

**SINGle** Triggering is executed by means of IEC-bus command `:TRIGger:LIST :IMM`. The list is executed once.

**EXTernal** Triggering is carried out from outside via the EXT.TRIG. socket or by the GET command via IEC/IEEE-bus (see annex A). The list is executed once

Example: `:TRIG:LIS:SOUR AUTO` \*RST value is SINGle

**:TRIGger:MSEquence**

This node contains all commands to trigger a memory sequence. The commands are only valid for TRIGger1.

**:TRIGger:MSEquence[:IMMediate]**

The command immediately starts a memory sequence. It corresponds to the EXECUTE SINGLE MODE command of the manual control in the MEMORY SEQUENCE menu. This command is an event and thus has no \*RST value.

Example: `:TRIG:MSEQ:IMM`

**:TRIGger:MSEquence:SOURce** AUTO | SINGle | EXTernal

The command specifies the trigger source (cf. `:TRIGger:SWEep:SOURce`)

Example: `:TRIG:MSEQ:SOUR AUTO` \*RST value is SINGle

**:TRIGger:PULSe**

This node contains all commands to trigger the pulse generator (option SM-B4). The commands are only valid for TRIGger1.

**:TRIGger:PULSe:SOURce** EXTernal | AUTO

The command specifies the trigger source.

EXTernal      Triggering is effected from outside via the PULSE socket.

AUTOTrigger is free-running (see above)

\*RST value is AUTO

Example:      :TRIG:PULS:SOUR AUTO

**:TRIGger:PULSe:SLOPe** POSitive | NEGative

The command indicates whether the action triggered is triggered at the positive or the negative edge of the trigger signal.

\*RST value is POSitiv

Example:      :TRIG:PULS:SLOP NEG

**:TRIGger:SLOPe** POSitive | NEGative

The command indicates whether the external trigger input only responds to the positive, the negative or to both edges of the trigger signal. The command acts on TRIGger:SWEep, TRIGger:LIST and TRIGger:MSEquence. The pulse generator has an own trigger input and thus also an own SLOPe command.

\*RST value is POSitiv

Example:      :TRIG:SLOP NEG



### 3.6.17 UNIT-System

This system contains the commands specifying which units are valid if no unit is indicated in a command. These settings are valid for the entire instrument.

Command	Parameter	Default Unit	Remark
<b>:UNIT</b> <b>:ANGLE</b> <b>:POWER</b>	DEGR <sub>ee</sub>   DEGR <sub>ee</sub>   RADian DBM   DBW   DBMW   DBUW   DBV   DBMV   DBUV   V		

**:UNIT:ANGLE** DEGR<sub>ee</sub> | DEGR<sub>ee</sub> | RADian

The command indicates the unit for angles.

\*RST value is RADian

Example:       :UNIT:ANGL DEGR

**:UNIT:POWER** DBM | DBW | DBMW | DBUW | DBV | DBMV | DBUV | V

The command indicates the unit for power.

\*RST value is DBM

Example:       :UNIT:POW V

### 3.7 Instrument Model and Command Processing

The instrument model shown in Fig. 3-2 has been made viewed from the standpoint of the servicing of IEC-bus commands. The individual components work independently of each other and simultaneously. They communicate by means of so-called "messages".

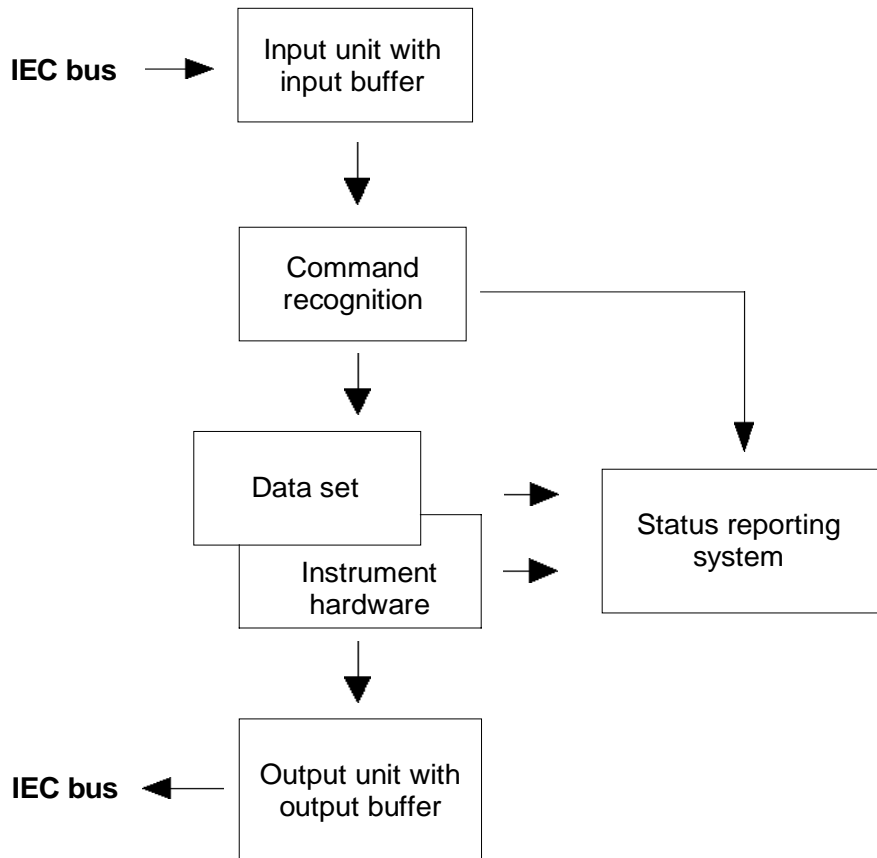

Fig. 3-2 Instrument model in the case of remote control by means of the IEC bus

#### 3.7.1 Input Unit

The input unit receives commands character by character from the IEC bus and collects them in the input buffer. The input buffer has a size of 256 characters. The input unit sends a message to the command recognition as soon as the input buffer is full or as soon as it receives a delimiter, <PROGRAM MESSAGE TERMINATOR>, as defined in IEEE 488.2, or the interface message DCL.

If the input buffer is full, the IEC-bus traffic is stopped and the data received up to then are processed. Subsequently the IEC-bus traffic is continued. If, however, the buffer is not yet full when receiving the delimiter, the input unit can already receive the next command during command recognition and execution. The receipt of a DCL clears the input buffer and immediately initiates a message to the command recognition.

### 3.7.2 Command Recognition

The command recognition analyses the data received from the input unit. It proceeds in the order in which it receives the data. Only a DCL is serviced with priority, a GET (Group Execute Trigger), e.g., is only executed after the commands received before as well. Each recognized command is immediately transferred to the data set but without being executed there at once.

Syntactical errors in the command are recognized here and supplied to the status reporting system. The rest of a command line after a syntax error is analyzed further if possible and serviced.

If the command recognition recognizes a delimiter or a DCL, it requests the data set to set the commands in the instrument hardware as well now. Subsequently it is immediately prepared to process commands again. This means for the command servicing that further commands can already be serviced while the hardware is still being set ("overlapping execution").

### 3.7.3 Data Set and Instrument Hardware

Here the expression "instrument hardware" denotes the part of the instrument fulfilling the actual instrument function - signal generation, measurement etc. The controller is not included.

The data set is a detailed reproduction of the instrument hardware in the software.

IEC-bus setting commands lead to an alteration in the data set. The data set management enters the new values (e.g. frequency) into the data set, however, only passes them on to the hardware when requested by the command recognition. As this is always only effected at the end of a command line, the order of the setting commands in the command line is not relevant.

The data are only checked for their compatibility among each other and with the instrument hardware immediately before they are transmitted to the instrument hardware. If the detection is made that an execution is not possible, an "execution error" is signaled to the status reporting system. All alterations of the data set are canceled, the instrument hardware is not reset. Due to the delayed checking and hardware setting, however, it is permissible to set impermissible instrument states within one command line for a short period of time without this leading to an error message (example: simultaneous activation of FM and PM). At the end of the command line, however, a permissible instrument state must have been reached again.

Before passing on the data to the hardware, the settling bit in the STATus:OPERation register is set (cf. Section 3.8.3.4). The hardware executes the settings and resets the bit again as soon as the new state has settled. This fact can be used to synchronize command servicing.

IEC-bus queries induce the data set management to send the desired data to the output unit.

### 3.7.4 Status Reporting System

The status reporting system collects information on the instrument state and makes it available to the output unit on request. The exact structure and function are described in Section 3.8.

### 3.7.5 Output Unit

The output unit collects the information requested by the controller, which it receives from the data set management. It processes it according to the SCPI rules and makes it available in the output buffer. The output buffer has a size of 256 characters. If the information requested is longer, it is made available "in portions" without this being recognized by the controller.

If the instrument is addressed as a talker without the output buffer containing data or awaiting data from the data set management, the output unit sends error message "Query UNTERMINATED" to the status reporting system. No data are sent on the IEC bus, the controller waits until it has reached its time limit. This behavior is specified by SCPI.

### 3.7.6 Command Sequence and Command Synchronization

What has been said above makes clear that all commands can potentially be carried out overlapping. Equally, setting commands within one command line are not absolutely serviced in the order in which they have been received.

In order to make sure that commands are actually carried out in a certain order, each command must be sent in a separate command line, that is to say, with a separate IBWRT()-call.

In order to prevent an overlapping execution of commands, one of commands \*OPC, \*OPC? or \*WAI must be used. All three commands cause a certain action only to be carried out after the hardware has been set and has settled. By a suitable programming, the controller can be forced to wait for the respective action to occur (cf. table 3-3).

Table 3-3 Synchronization with \*OPC?, \*OPC? And \*WAI

Com-mand	Action after the hardware has settled	Programming the controller
*OPC	Setting the operation-complete bit in the ESR	- Setting bit 0 in the ESE - Setting bit 5 in the SRE - Waiting for service request (SRQ)
*OPC?	Writing a "1" into the output buffer	Addressing the instrument as a talker
*WAI	Executing the next command Note: The IEC-bus handshake is not stopped	Sending the next command

An example as to command synchronization can be found in annex D "Program Examples".

### 3.8 Status Reporting System

The status reporting system (cf. Fig. 3-4) stores all information on the present operating state of the instrument, e.g. that the instrument presently carries out an AUTORANGE and on errors which have occurred. This information is stored in the status registers and in the error queue. The status registers and the error queue can be queried via IEC bus.

The information is of a hierarchical structure. The register status byte (STB) defined in IEEE 488.2 and its associated mask register service request enable (SRE) form the uppermost level. The STB receives its information from the standard event status register (ESR) which is also defined in IEEE 488.2 with the associated mask register standard event status enable (ESE) and registers STATUS:OPERation and STATUS:QUESTionable which are defined by SCPI and contain detailed information on the instrument.

The IST flag ("Individual S<sub>T</sub>atus") and the parallel poll enable register (PPE) allocated to it are also part of the status reporting system. The IST flag, like the SRQ, combines the entire instrument status in a single bit. The PPE fulfills an analog function for the IST flag as the SRE for the service request.

The output buffer contains the messages the instrument returns to the controller. It is not part of the status reporting system but determines the value of the MAV bit in the STB and thus is represented in Fig. 3-4.

#### 3.8.1 Structure of an SCPI Status Register

Each SCPI register consists of 5 parts which each have a width of 16 bits and have different functions (cf. Fig. 3-3). The individual bits are independent of each other, i.e. each hardware status is assigned a bit number which is valid for all five parts. For example, bit 3 of the STATUS:OPERation register is assigned to the hardware status "wait for trigger" in all five parts. Bit 15 (the most significant bit) is set to zero for all parts. Thus the contents of the register parts can be processed by the controller as positive integer.

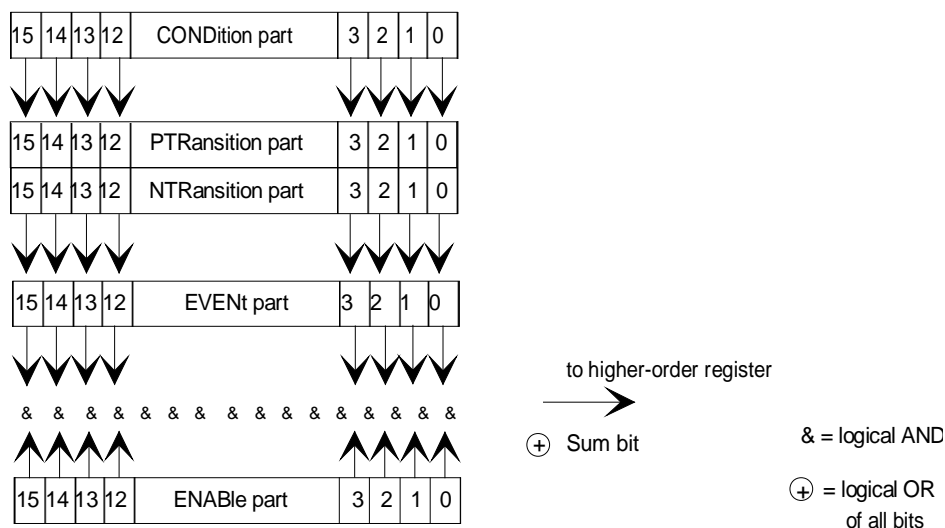

Fig. 3-3 The status -register model

<b>CONDition part</b>	The CONDition part is directly written into by the hardware or the sum bit of the next lower register. Its contents reflects the current instrument status. This register part can only be read, but not written into or cleared. Its contents is not affected by reading.
<b>PTRansition part</b>	The <u>P</u> ositive- <u>T</u> Ransition part acts as an edge detector. When a bit of the CONDition part is changed from 0 to 1, the associated PTR bit decides whether the EVENT bit is set to 1. PTR bit =1: the EVENT bit is set. PTR bit =0: the EVENT bit is not set. This part can be written into and read at will. Its contents is not affected by reading.
<b>NTRansition part</b>	The <u>N</u> egative- <u>T</u> Ransition part also acts as an edge detector. When a bit of the CONDition part is changed from 1 to 0, the associated NTR bit decides whether the EVENT bit is set to 1. NTR bit =1: the EVENT bit is set. NTR bit =0: the EVENT bit is not set. This part can be written into and read at will. Its contents is not affected by reading. With these two edge register parts the user can define which state transition of the condition part (none, 0 to 1, 1 to 0 or both) is stored in the EVENT part.
<b>EVENT part</b>	The EVENT part indicates whether an event has occurred since the last reading, it is the "memory" of the condition part. It only indicates events passed on by the edge filters. It is permanently updated by the instrument. This part can only be read by the user. During reading, its contents is set to zero. In linguistic usage this part is often equated with the entire register.
<b>ENABLE part</b>	The ENABLE part determines whether the associated EVENT bit contributes to the sum bit (cf. below). Each bit of the EVENT part is ANDed with the associated ENABLE bit (symbol '&'). The results of all logical operations of this part are passed on to the sum bit via an OR function (symbol '+'). ENAB bit =0: the associated EVENT bit does not contribute to the sum bit ENAB bit =1: if the associated EVENT bit is "1", the sum bit is set to "1" as well. This part can be written into and read by the user at will. Its contents is not affected by reading.
<b>Sum bit</b>	As indicated above, the sum bit is obtained from the EVENT and ENABLE part for each register. The result is then entered into a bit of the CONDition part of the higher-order register. The instrument automatically generates the sum bit for each register. Thus an event, e.g. a PLL that has not locked, can lead to a service request throughout all levels of the hierarchy.
<b>Note:</b>	<i>The service request enable register SRE defined in IEEE 488.2 can be taken as ENABLE part of the STB if the STB is structured according to SCPI. By analogy, the ESE can be taken as the ENABLE part of the ESR.</i>

### 3.8.2 Overview of the Status Registers

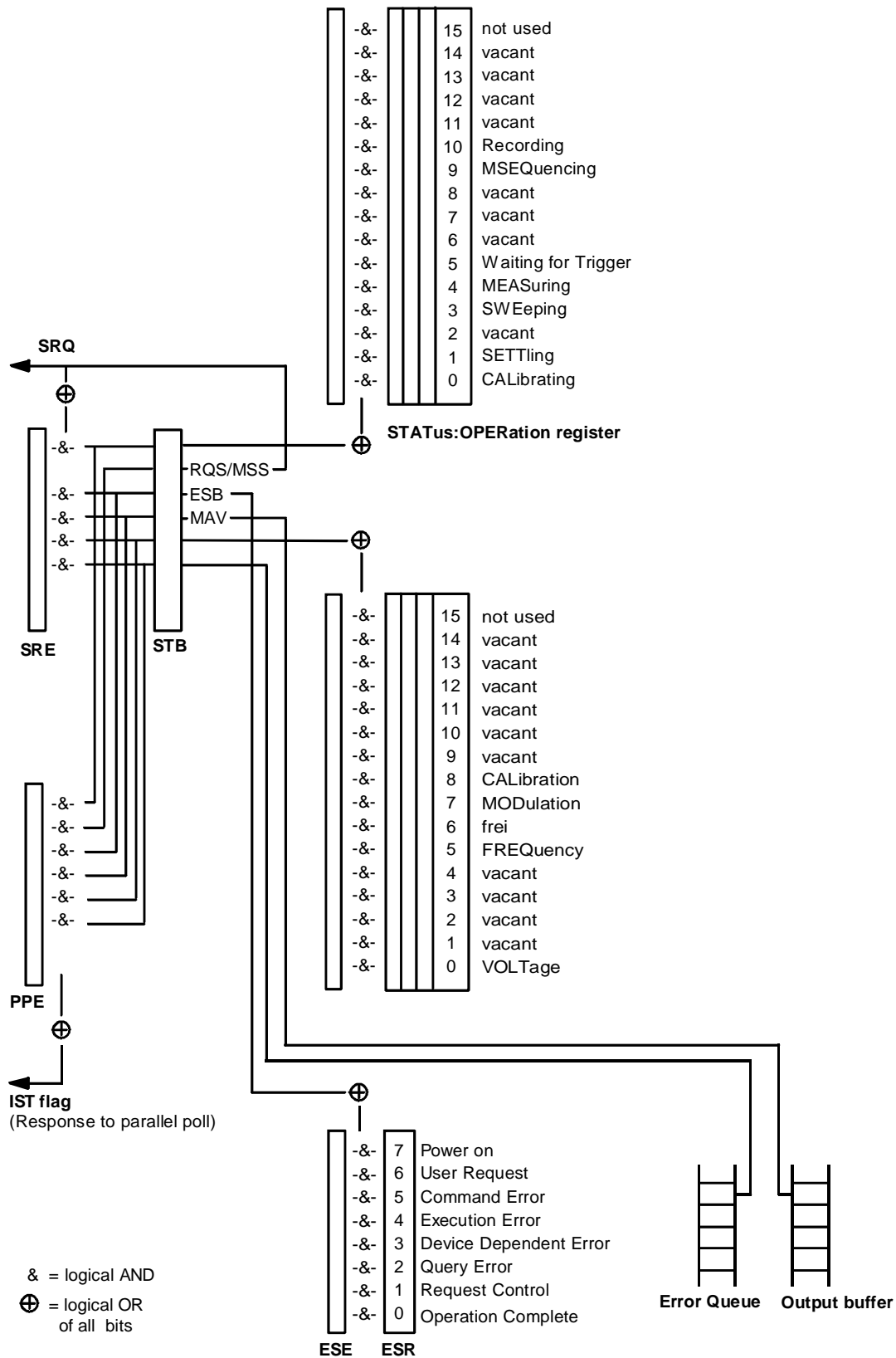

Fig. 3-4 Overview of the status register

### 3.8.3 Description of the Status Registers

#### 3.8.3.1 Status Byte (STB) and Service Request Enable Register (SRE)

The STB is already defined in IEEE 488.2. It provides a rough overview of the instrument status by collecting the pieces of information of the lower registers. It can thus be compared with the CONDition part of an SCPI register and assumes the highest level within the SCPI hierarchy. A special feature is that bit 6 acts as the sum bit of the remaining bits of the status byte.

The STATUS BYTE is read out using the command "**\*STB?**" or a serial poll.

The STB implies the SRE. It corresponds to the ENABLE part of the SCPI registers as to its function. Each bit of the STB is assigned a bit in the SRE. Bit 6 of the SRE is ignored. If a bit is set in the SRE and the associated bit in the STB changes from 0 to 1, a Service Request (SRQ) is generated on the IEC bus, which triggers an interrupt in the controller if this is appropriately configured and can be further processed there.

The SRE can be set using command "**\*SRE**" and read using "**\*SRE?**".

Table 3-4 Overview of the status register

Bit no.	Meaning
2	<p><b>Error Queue not empty</b></p> <p>The bit is set when an entry is made in the error queue. If this bit is enabled by the SRE, each entry of the error queue generates a Service Request. Thus an error can be recognized and specified in greater detail by polling the error queue. The poll provides an informative error message. This procedure is to be recommended since it considerably reduces the problems involved with IEC-bus control.</p>
3	<p><b>QUESTionable status sum bit</b></p> <p>The bit is set if an EVENT bit is set in the QUESTionable status register and the associated ENABLE bit is set to 1. A set bit indicates a questionable instrument status, which can be specified in greater detail by polling the QUESTionable status register.</p>
4	<p><b>MAV-Bit (Message AVailable)</b></p> <p>The bit is set if a message is available in the output buffer which can be read. This bit can be used to enable data to be automatically read from the instrument to the controller (cf. annex D, program examples).</p>
5	<p><b>ESB bit</b></p> <p>Sum bit of the event status register. It is set if one of the bits in the event status register is set and enabled in the event status enable register. Setting of this bit implies a serious error which can be specified in greater detail by polling the event status register.</p>
6	<p><b>MSS-Bit (Master Status Summary bit)</b></p> <p>The bit is set if the instrument triggers a service request. This is the case if one of the other bits of this register is set together with its mask bit in the service request enable register SRE.</p>
7	<p><b>OPERation status register sum bit</b></p> <p>The bit is set if an EVENT bit is set in the OPERation status register and the associated ENABLE bit is set to 1. A set bit indicates that the instrument is just performing an action. The type of action can be determined by polling the OPERation status register.</p>



### 3.8.3.2 IST Flag and Parallel Poll Enable Register (PPE)

By analogy with the SRQ, the IST flag combines the entire status information in a single bit. It can be queried by means of a parallel poll (cf. Section 3.8.4.3) or using command "\*IST?".

The parallel poll enable register (PPE) determines which bits of the STB contribute to the IST flag. The bits of the STB are ANDed with the corresponding bits of the PPE, with bit 6 being used as well in contrast to the SRE. The Ist flag results from the ORing of all results. The PPE can be set using commands "\*PRE" and read using command "\*PRE?".

### 3.8.3.3 Event Status Register (ESR) and Event Status Enable Register (ESE)

The ESR is already defined in IEEE 488.2. It can be compared with the EVENT part of an SCPI register. The event status register can be read out using command "\*ESR?".

The ESE is the associated ENABLE part. It can be set using command "\*ESE" and read using command "\*ESE?".

Table 3-5 Meaning of the bits used in the event status register

Bit No.	Meaning
0	<b>Operation Complete</b> This bit is set on receipt of the command *OPC exactly when all previous commands have been executed.
2	<b>Query Error</b> This bit is set if either the controller wants to read data from the instrument without having sent a query, or if it does not fetch requested data and sends new instructions to the instrument instead. The cause is often a query which is faulty and hence cannot be executed.
3	<b>Device-dependent Error</b> This bit is set if a device-dependent error occurs. An error message with a number between -300 and -399 or a positive error number, which denotes the error in greater detail, is entered into the error queue (cf. annex B, Error Messages).
4	<b>Execution Error</b> This bit is set if a received command is syntactically correct, however, cannot be performed for other reasons. An error message with a number between -200 and -300, which denotes the error in greater detail, is entered into the error queue (cf. annex B, Error Messages).
5	<b>Command Error</b> This bit is set if a command which is undefined or syntactically incorrect is received. An error message with a number between -100 and -200, which denotes the error in greater detail, is entered into the error queue (cf. annex B, Error Messages).
6	<b>User Request</b> This bit is set on pressing the LOCAL key, i.e., when the instrument is switched over to manual control.
7	<b>Power On</b> (supply voltage on) This bit is set on switching on the instrument.

### 3.8.3.4 STATus:OPERation Register

In the CONDition part, this register contains information on which actions the instrument is being executing or, in the EVENt part, information on which actions the instrument has executed since the last reading. It can be read using commands "STATus:OPERation:CONDition?" or "STATus:OPERation [:EVENT]?"..

Table 3-6 Meaning of the bits used in the STATus:OPERation register

Bit-No.	Meaning
0	<b>CALibrating</b> This bit is set as long as the instrument is performing a calibration.
1	<b>SETTling</b> This bit is set as long as the new status is settling after a setting command. It is only set if the settling time is longer than the command processing time.
3	<b>SWEeping</b> This bit is set while the instrument is performing a sweep.
4	<b>MEASuring</b> This bit is set while the instrument is performing a measurement.
5	<b>WAIT for TRIGGER</b> This bit is set as long as the instrument is waiting for a trigger event.
8	<b>LEARning</b> This bit is set while the instrument is "learning" a list.
9	<b>MSEQuencing</b> This bit is set while the instrument is performing a memory sequence.
10	<b>RECording</b> This bit is set while the instrument is recording external data via the DATA input.

### 3.8.3.5 STATus:QUEStionable Register

This register contains information on questionable instrument states. They can occur, e.g. if the instrument is operated out of its specifications. It can be queried using commands "STATus:QUEStionable:CONDition?" or "STATus:QUEStionable[:EVENT]?".

Table 3-7 Meaning of the bits used in the STATus:QUEStionable register

Bit-No.	Meaning
0	<p><b>VOLTage</b></p> <p>This bit is set if the voltage at an output connector is not correct, if the voltage is above or below the specified limit values, if the level limit has responded, if the overvoltage protection has responded.</p>
5	<p><b>FREQuency</b></p> <p>The bit is set if a frequency at the RF output is not correct or if it is lower or higher than the specified values</p>
7	<p><b>MODulation</b></p> <p>The bit is set if a modulation is not correct or is operated outside the specifications.</p>
8	<p><b>CALibration</b></p> <p>The bit is set if a calibration is not performed properly.</p>

### 3.8.4 Application of the Status Reporting Systems

In order to be able to effectively use the status reporting system, the information contained there must be transmitted to the controller and further processed there. There are several methods which are represented in the following. Detailed program examples are to be found in annex D, Program Examples.

#### 3.8.4.1 Service Request, Making Use of the Hierarchy Structure

Under certain circumstances, the instrument can send a service request (SRQ) to the controller. Usually this service request initiates an interrupt at the controller, to which the control program can react with corresponding actions. As evident from Fig. 3.4 (Section 3.8.2), an SRQ is always initiated if one or several of bits 2, 3, 4, 5 or 7 of the status byte are set and enabled in the SRE. Each of these bits combines the information of a further register, the error queue or the output buffer. The corresponding setting of the ENABLE parts of the status registers can achieve that arbitrary bits in an arbitrary status register initiate an SRQ. In order to make use of the possibilities of the service request, all bits should be set to "1" in enable registers SRE and ESE.

Examples (cf. Fig. 3.4, Section 3.8.2 and Program Examples, annex D as well):

Use of command "`*OPC`" to generate an SRQ

- Set bit 0 in the ESE (Operation Complete)
- Set bit 5 in the SRE (ESB)

After its settings have been completed, the instrument generates an SRQ.

Indication of the end of a sweep by means of an SRQ with the controller

- Set bit 7 in the SRE (sum bit of the STATus:OPERation register)
- Set bit 3 (sweeping) in the STATus:OPERation:ENABLE.
- Set bit 3 in the STATus:OPERation:NTRansition so as to make sure that the transition of sweeping bit 3 from 1 to 0 (sweep end) is recorded in the EVENT part.

After a sweep has been completed, the instrument generates an SRQ.

The SRQ is the only possibility for the instrument to become active on its own. Each controller program should set the instrument such that a service request is initiated in the case of malfunction. The program should react appropriately to the service request. A detailed example for a service request routine is to be found in annex D, Program Examples.

#### 3.8.4.2 Serial Poll

In a serial poll, just as with command "`*STB`", the status byte of an instrument is queried. However, the query is realized via interface messages and is thus clearly faster. The serial-poll method has already been defined in IEEE 488.1 and used to be the only standard possibility for different instruments to poll the status byte. The method also works with instruments which do not adhere to SCPI or IEEE 488.2.

The quick-BASIC command for executing a serial poll is "`IBRSP()`". Serial poll is mainly used to obtain a fast overview of the state of several instruments connected to the IEC bus.

### 3.8.4.3 Parallel Poll

In a parallel poll, up to eight instruments are simultaneously requested by the controller by means of a single command to transmit 1 bit of information each on the data lines, i.e., to set the data line allocated to each instrument to logically "0" or "1". By analogy to the SRE register which determines under which conditions an SRQ is generated, there is a parallel poll enable register (PPE) which is ANDed with the STB bit by bit as well considering bit 6. The results are ORed, the result is then sent (possibly inverted) as a response in the parallel poll of the controller. The result can also be queried without parallel poll by means of command `*IST`.

The instrument first has to be set for the parallel poll using quick-BASIC command `IBPPC()`. This command allocates a data line to the instrument and determines whether the response is to be inverted. The parallel poll itself is executed using `IBRPP()`.

The parallel-poll method is mainly used in order to quickly find out after an SRQ which instrument has sent the service request if there are many instruments connected to the IEC bus. To this effect, SRE and PPE must be set to the same value. A detailed example as to the parallel poll is to be found in annex D, Program Examples.

### 3.8.4.4 Query by Means of Commands

Each part of every status register can be read by means of queries. The individual commands are indicated in the detailed description of the registers in Section 3.8.3. What is returned is always a number which represents the bit pattern of the register queried. Evaluating this number is effected by the controller program.

Queries are usually used after an SRQ in order to obtain more detailed information on the cause of the SRQ.

### 3.8.4.5 Error Queue Query

Each error state in the instrument leads to an entry in the error queue. The entries of the error queue are detailed plain-text error messages which can be looked at in the ERROR menu via manual control or queried via the IEC bus using command `SYSTEM:ERROR?`. Each call of `SYSTEM:ERROR?` provides one entry from the error queue. If no error messages are stored there any more, the instrument responds with 0, "No error"

The error queue should be queried after every SRQ in the controller program as the entries describe the cause of an error more precisely than the status registers. Especially in the test phase of a controller program the error queue should be queried regularly since faulty commands from the controller to the instrument are recorded there as well.

### 3.8.5 Resetting Values of the Status Reporting Systems

Table 3-8 comprises the different commands and events causing the status reporting system to be reset. None of the commands, except for \*RST and SYSTem:PRESet influences the functional instrument settings. In particular, DCL does not change the instrument settings.

Table 3-8 Resetting instrument functions

Event	Switching on supply voltage		DCL,SDC  (Device Clear, Selected Device Clear)	*RST or SYSTem:PRESet	STATus:PRESet	*CLS
	Power-On-Status-Clear					
	0	1				
Effect						
Clear STB,ESR	—	yes	—	—	—	yes
Clear SRE,ESE	—	yes	—	—	—	—
Clear PPE	—	yes	—	—	—	—
Clear EVENT parts of the registers	—	yes	—	—	—	yes
Clear ENABLE parts of all OPERation-and QUESTionable registers, Fill ENABLE parts of all other registers with "1".	—	yes	—	—	yes	—
Fill PTRansition parts with „1“ Clear NTRansition parts	—	yes	—	—	yes	—
Clear error queue	yes	yes	—	—	—	yes
Clear output buffer	yes	yes	yes	1)	1)	1)
Clear command processing and input buffer	yes	yes	yes	—	—	—

1) Every command being the first in a command line, i.e. immediately following a <PROGRAM MESSAGE TERMINATOR> clears the output buffer.

### 3.9 Fast Restore Mode

The Fast Restore mode is available with **SME03A** and units that are equipped with option Fast CPU for SMIQ **SM-B50**. Device settings can be saved and recalled very quickly via the IEC/IEEE bus using the commands described below. 1000 memory locations are available.

In contrast to the SAVE/RECALL function, not the unit parameters but only the setting data of the modules are stored in the Fast Restore mode. RESTORE by means of the ':SYSTem:SREStore' or '!..' command has an immediate effect on the module. The database (which stores all entries and delivers the display data) is bypassed. This allows a very high setup speed.

#### Commands:

##### **:SYSTem:SSAVe 1...1000**

This command saves the current device setting at the memory location indicated.

##### **:SYSTem:SREStore 1...1000**

This command loads a device status that was stored using the :SYSTem:SSAVe command (RESTORE). One of 1000 available memory locations is selected by entering a numeral.

##### **! <least significant byte> <most significant byte>**

This command has the same effect as the:SYSTem:SREStore command. The setting time however is 300  $\mu$ s less. It is optimized for highest speed and does not comply with the SCPI syntax regulations. Exactly 3 bytes are transmitted including the '!' (which is the identifier of this command). With the last byte, EOI has to be activated as delimiter.

The memory location is binary-coded in the 2 bytes indicated.

#### **Example:**

RESTORE at memory location 268 (-> 010C hex) corresponds to the following binary command:

```
0010 0001  0000 1100  0000 0001
   '!'      hex 0C      hex 01
```

Binary-coded bytes can usually not be written as printable ASCII characters.

When programmed in C, the above command has the following form:

```
char sendstring[3] = {'!', 0x0C, 0x01}
```

In BASIC, the command string to be output is as follows:

```
'!' + CHR$(12) + CHR$(1)
```

(The pros for CHR\$ are decimal numbers, therefore 12 for 0C hex.)

Since binary-coded bytes may also have the value of the LF (line feed) character which is interpreted as a delimiter, switch over to 'only EOI' as delimiter by selecting ':SYSTem:COMMunicate:GPIB:LTERminator EOI' prior to using this command.

## Call-up and termination of operating mode

After a RESTORE, the database does no longer reflect the device setting which means

- the displayed values are no longer relevant,
- the desired result is not obtained by a query of setup values.
- normal setting commands may not be executed properly (see below 'Alternative ...')

It is therefore recommended either

- to use the \*RST command or
- to store the device setting prior to using the first RESTORE command by means of the :SYSTEM:SSAVe n command and to restore it after the last RESTORE command using :SYSTEM:SRESTore n. The database and the device setting will then match again.

No other commands are required to activate or deactivate this mode.

- Note:**
- *Since the module setting depends on the temperature of the unit, any temperature variation of more than 5°C should be avoided between storage and call-up to ensure the accuracy of the unit.*
  - *If the mechanically switched attenuator is switched over due to a RESTORE command, the setting time increases by 15 ms. This can be avoided by setting one of the two functions for interruption-free level setting (:OUTPUT:AMODE FIXed) prior to storing the setting.*

## Effects on device settings:

The Fast Restore commands have an effect on almost all device settings (see table).

Device settings stored and called up by Fast Restore:	Device settings not stored or called up by Fast Restore:
<ul style="list-style-type: none"> <li>• Frequency incl. reference oscillator</li> <li>• Level - incl. mech. switched attenuator, - incl. user correction, - incl. ALC modes</li> <li>• Analog modulation: AM, FM, PM</li> <li>• Switch-on/off of digital modulation</li> <li>• Standard LF generator (4 fixed frequencies)</li> </ul>	<ul style="list-style-type: none"> <li>• Settings of digital modulation</li> <li>• Functions not regarding the RF output signal, eg commands under :SYSTEM:... (except for SYSTEM:PRESet) or :UNIT:...</li> <li>• Sweep</li> <li>• List mode</li> <li>• Memory sequence</li> <li>• Options LF generator (SM-B2) and multifunction generator (SM-B6) incl. LF output stereo and VOR/ILS modulation</li> <li>• Pulse modulation and pulse generator</li> </ul>

## Alternative use with other IEC/IEEE-bus commands:

The alternative use of the RESTORE commands (:SYSTEM:SRESTore' or '!..') and normal IEC/IEEE-bus commands is

- useful in case of digital modulation:  
First, the digital modulation is configured and switched on by means of normal commands. Then, digital modulation can be switched on/off by means of the RESTORE .
- possible for all commands that do not regard the RF output signal (eg :SYSTEM:..., :UNIT:...),
- normally not possible for all the functions listed in the left column of the above table. In case of doubt, we recommend testing.

## Synchronization signal

In the Fast Restore mode a synchronization signal is available at the rear-panel BLANK connector to synchronize other devices.

The BLANK signal is high during settling of the RF output signal and low in the settled state.





### 4.1.3.1 Exchange of RAM Battery



*Caution:*

*Before opening the unit, disconnect power plug. When working on the open unit make sure to meet applicable ESD regulations.*

#### Opening the instrument

- Remove all cable connections.
- Screw off front panel (4 Phillips screws at the corners) and tilt towards the front.  
The shielding cover (cf. Fig. 4-1) of the controller and the front panel modules is now freely accessible.
- Detach cable connection to the IEC bus (Fig. 4-1, pos. 3) and to the RS-232 interface (Fig. 4.1, pos. 4). The connection to the motherboard (Fig. 4-1, pos. 2) can remain plugged in.
- Screw off cover (6 screws (Fig. 4-1, pos. 1)) and lift off.  
The computer PCB is now accessible from the top.

#### Exchanging the battery

The position of the battery on the computer PCB is evident from Fig.4-2.

- Detach jumper X300 (cf. Fig. 4-2, pos. 2).
- Cut off cable tie.
- Unsolder battery.
- Detach cable at plug connector X312 (cf. Fig. 4-2, pos. 1). The remaining cable connections can remain plugged in.
- Remove 2 fastening screws (cf. Fig. 4-2, pos. 5) on the computer PCB.
- Lift computer PCB and thread new battery clamp.
- Screw on computer PCB (cf. Fig. 4-2, pos. 5), establish plug connection X312 (cf. Fig. 4-2, pos. 1).
- Fix new battery in position using cable tie.

**Caution!** *Observe the polarity when fixing and soldering the battery (cf. Fig. 4-2 and marking on the PCB). A wrong polarity will lead to the destruction of components.*

- Shorten connection wires to the necessary length and solder battery.
- Plug jumper X300 (cf. Fig. 4-2, pos. 2).

#### Closing the instrument

Closing the instrument is effected in the reverse order as opening it.

**Caution!** *Ensure that the braided cord in the casing slots is fitted correctly.*

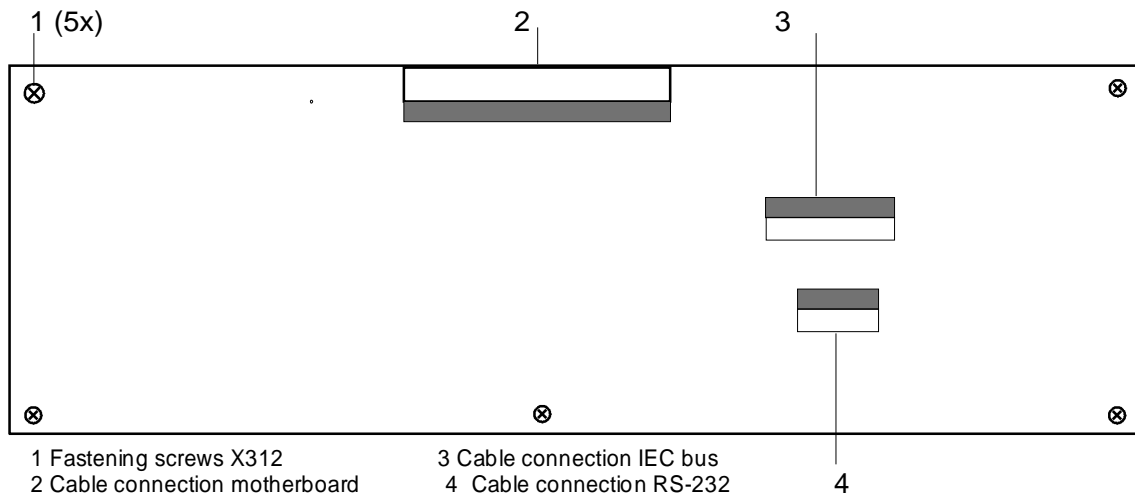

Fig. 4-1 Shielding cover of controller and front panel module

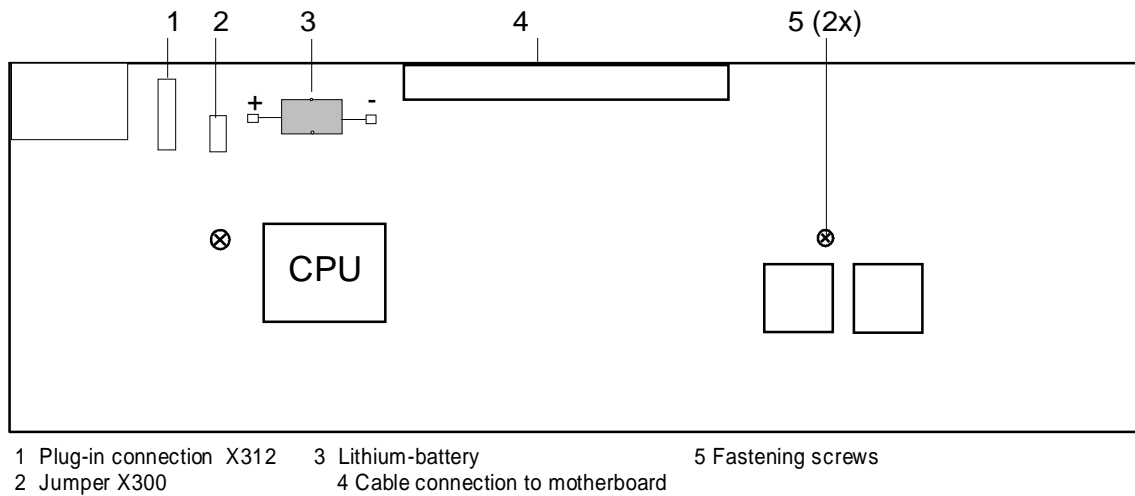

Fig. 4-2 Position of the RAM battery on the PCB (side where the components are fitted)

### 4.1.3.2 Exchange of XMEM Battery

**Caution!**

*Before opening the unit, disconnect power plug. When working on the open unit make sure to meet applicable ESD regulations.*

**Removing  
Option SME-B12**

- Switch off unit and disconnect power plug.
- Remove all cable connections.
- Undo the four screws of the rear-panel feet and remove feet.
- Push top panelling towards the rear and remove.
- Turn unit upside down.
- Remove bottom panelling.
- On each locking rail, undo two screws in the oblong holes.
- Push the locking rails towards the front by using a screwdriver.
- Withdraw option SME-B12.

**Exchanging  
the battery**

For the location of the battery on the computer PCB refer to Fig. 4-3.

- Unplug jumper X2 (cf. Fig. 4-3, item 1).
- Cut off cable ties.
- Unsolder battery G1 (cf. Fig. 4-3, item 2).
- Fix new battery with cable ties.

**Caution!** *Observe the polarity when fixing and soldering the battery (cf. Fig. 4-3 and marking on the PCB). The solder tag for the positive pole is located close to jumper X2. A wrong polarity will lead to the destruction of components.*

- Shorten connection wires to the necessary length and solder battery.
- Plug jumper X2 (cf. Fig. 4-3, pos. 1).

**Fitting  
Option SME-B12**

- Shorten connection wires to the necessary length and solder battery.
- Plug jumper X2 (cf. Fig. 4-3, pos. 1).

**Caution!** *Ensure that the braided cord in the casing slots is fitted correctly.*

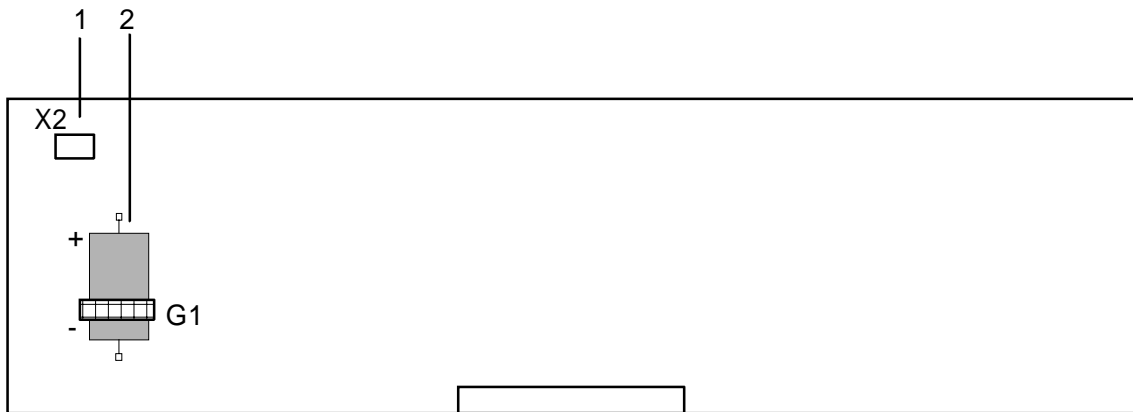

1 Jumper X2      2 Lithium battery

Fig. 4-3 Position of the XMEM battery on option SME-B12 (side where the components are fitted)

## 4.2 Functional Test

The SME carries out a selftest on switching on the instrument and permanently during operation. On switching on, the RAM and ROM contents are checked and the batteries of the non-volatile RAMs and of the memory extension are tested. If an error is detected, this is indicated through a corresponding error message. The most important instrument functions are automatically monitored during operation.

If a faulty function is detected in the selftest, ERROR is displayed in the status line. To identify the error, the ERROR menu, in which the error messages are entered, can be called by pressing the [ERROR] key (cf. Chapter 2, Section "Error Messages").

The tests can additionally be called via the menu.

Access to the tests is offered by the UTILITIES - TEST menu.

Menu selection:      UTILITIES - TEST

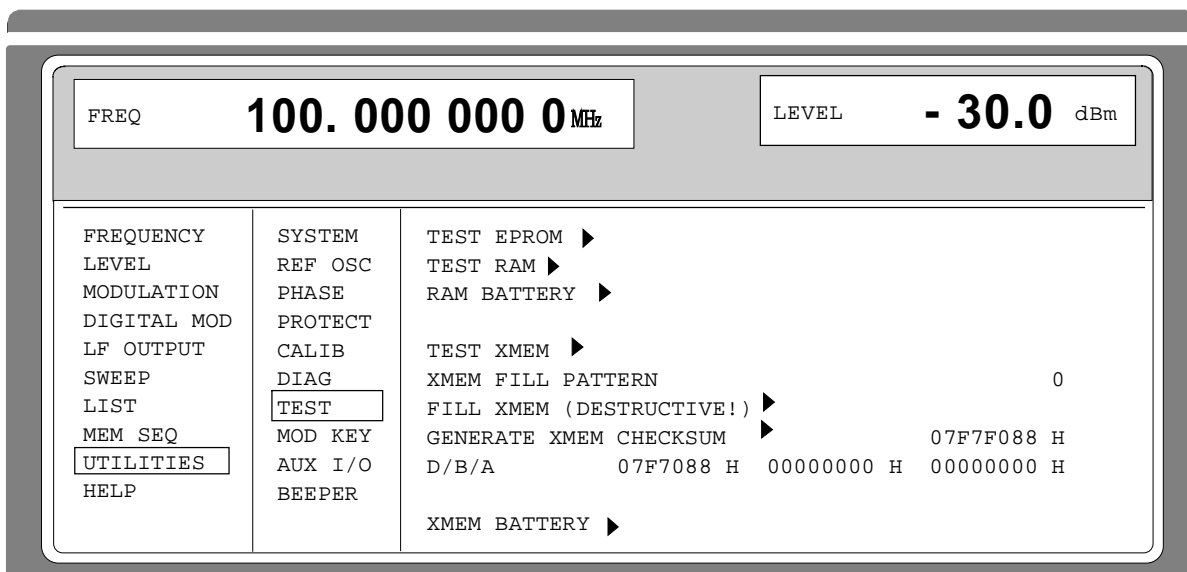

Fig. 4-4 UTILITIES-TEST menu, fitted with Option SME-B11, DM Coder, and SME-B12, Memory Extension.

---

<b>TEST EPROM ►</b>	Tests the EPROM. The test result is displayed in a window.
<b>TEST RAM ►</b>	Tests the RAM. The test result is displayed in a window.
<b>RAM BATTERY →</b>	Tests the RAM battery. The test result is displayed in a window.
<b>TEST XMEM →</b>	Tests the memory of option SME-B12 (8 MBit) without overwriting the contents. The test result is displayed in a window.  <b>Caution:</b> <i>The unit must not be switched off during the test run.</i>
<b>XMEM FILL PATTERN</b>	Input value of the 8-bit pattern to fill the memory of option SME-B12. This value is entered as a decimal equivalent (0-255). If the input value = 256, the memory is continuously filled with the sequence from 0 to 255.
<b>FILL XMEM (DESTRUCTIVE!)→</b>	Fills the complete memory of option SME-B12 with the 8-bit pattern entered under XMEM FILL PATTERN.  <b>Caution:</b> <i>Stored data will be overwritten.</i>
<b>GENERATE XMEM CHECKSUM →</b>	Calculates the checksum of the active memory area of option SME-B12. The active memory area is fixed by parameters START ADDRESS, LENGTH and MEM MODE in the submenu CONFIG XMEM... . The checksum for the first line applies to the data in the MEM MODE = 8M*1. The checksums for the second line (D/B/A) apply to the DATA, BURST and LEV ATT memory in the MEM MODE = 1M*3.
<b>XMEM BATTERY →</b>	Tests the XMEM battery (Memory extension, option SME-B12). The test result is displayed in a window.

## 5 Performance Test

### 5.1 Test Instruments and Utilities

Table 5-1 Test Instruments and Utilities

Item	Type of instrument	Specifications required	Suitable R&S instrument	R&S order no.	Application
1	Frequency counter (included item 2)	1Hz to 1.5 GHz (SME02) 1Hz to 3 GHz (SME03), 1Hz to 6 GHz (SME06), Resolution 0.1 Hz			5.2.2 5.2.4
2	RF spectrum analyzer	100 Hz to 5 GHz (SME02/03), 100 Hz to 18 GHz (SME06) synthesizer tuning, dynamic range >80 dB	FSB FSM	0848.0020.52 1020.7020.52	5.2.3 5.2.5 5.2.6 5.2.7 5.2.8 5.2.11 5.2.12 5.2.32 5.2.33 5.2.34 5.2.35
3	Storage oscilloscope	100-M samples/s, averaging function			5.1.1.5 5.2.3
4	Controller	Industrial standard PC/XT/AT with IEC-625 interface R&S Basic	PSA 15	1012.1003.03	5.2.3 5.2.35
5	Signal generator of high spectral purity	0.1 MHz to 1.5 GHz (SME02) 0.1 MHz to 3 GHz (SME03), 0.1 MHz to 6 GHz (SME06), SSB noise level <-126 dBc with 1GHz/20 kHz	SME02, SME03, SME06	1038.6002.02/03/0 6	5.1.1.3 5.1.1.4 5.1.1.5 5.2.7 5.2.8 5.2.12 5.2.14
6	Phase noise test setup	Mixer: 10 MHz to 1.5 GHz (SME02) 10 MHz to 3 GHz (SME03), 10 MHz to 6 GHz (SME06), separating filter 2 MHz, preamplifier with 40-dB changeover switch, input noise <2nV (1Hz)			5.2.7 5.2.8
7	Oscilloscope	Bandwidth > 100 MHz, two channels with d.c. coupling			5.1.1.4 5.2.7 5.2.8 5.2.40
8	RF power meter	5 kHz to 1.5 GHz (SME02) 5 kHz to 3 GHz (SME03), 5 kHz to 6 GHz (SME06),	NRVS NRVS-Z51	1020.1809.02 857.9004.02	5.2.11 5.2.13
9	Precision attenuation set	Attenuation 0 to 120 dB, resolution 5 dB	DPSP RSG	8334.6010.02	5.2.11

Item	Type of instrument	Specification required	Suitable R&S instrument	R&S order no.	Application
10	Low-noise preamplifier	5 kHz to 1.5 GHz (SME02) 5 kHz to 3 GHz (SME03), 5 kHz to 6 GHz (SME06), amplification > 20 dB, noise factor < 10 dB			5.2.11
11	VSWR bridge	1 MHz to 1.5 GHz (SME02) 1 MHz to 3 GHz (SME03/06), directivity > 40 dB	ZRC	1039.9492.55/52	5.2.12
12	D.c. voltage source	Setting range 0 to 10 V	NGT 20	117.7133.02	5.2.14 5.2.33
13	RF power amplifier	10 MHz to 1.5 GHz (SME02) 10 MHz to 3 GHz (SME03/06), Power > 1W			5.2.14
14	Audio analyzer	Generator up to 100 kHz, level meter, distortion meter	UPD	1030.7500.04/05	5.1.1.2 5.2.31 5.2.39
15	Modulation analyzer	100 kHz to 1.5 GHz (SME02) 100 kHz to 3 GHz (SME03/06) AM, FM, PhiM, stereo coder, stereo decoder, distortion meter weighting filter CCIR, CCITT	FMB	856.5005.52	5.1.1.1 5.1.1.2
16	Mixer	10 MHz to 1.5 GHz (SME02) 10 MHz to 3 GHz (SME03), 10 MHz to 6 GHz (SME06), "high level"			5.1.1.3 5.1.1.4 5.1.1.5
17	Pulse generator	Pulse repetition frequency up to 10 MHz, level TTL	AFG	377.2100.02	5.1.1.4 5.2.32 5.2.33 5.2.40
18	Sine-wave generator	10 Hz to 2 MHz, 1 V (U peak)	AMS, ADS, AFG	1013.0000.02, 1013.1494.02, 377.2100.02	5.1.1.3
19	AC voltmeter	10 Hz to 2 MHz	URE3	350.5315.03	5.1.1.3 5.2.39
20	Broadband FM demodulator	Delay line discriminator, input frequency 50 MHz, slope 5 V/MHz, demodulation bandwidth 2 MHz			5.1.1.3 5.1.1.5
21	RF attenuator pad	D.c. to 1.5 GHz (SME02), D.c. to 3 GHz (SME03), D.c. to 6 GHz (SME06) 3 dB			5.1.1.3 5.1.1.4 5.1.1.5
22	Lowpass filter	Attenuation up to 50 MHz < 1 dB with 100 MHz > 20 dB with 200 MHz > 40 dB			5.1.1.3 5.1.1.4 5.1.1.5



Item	Type of instrument	Specification required	Suitable R&S instrument	R&S order no.	Application
23	Demodulator for digital modulations	Vector error measurement with QPSK modulation Phase error measurement with GMSK modulation	FSEA20 with option FSE-B7	1065.6000.20 1066.4317.02	5.2.34.2 5.2.35.2
25	VSWR directional coupler	3 GHz to 6 GHz (SME06)			5.2.12
26	RF attenuator	D.c. to 6 GHz (SME06) 20 dB			5.1.1.6

### 5.1.1 Test Systems to Measure Modulation Characteristics

#### 5.1.1.1 Standard Test System

Test equipment

- Modulation analyzer (Section 5.1, item 15)
- Oscilloscope for 5.2.35 to 5.2.37 (Section 5.1, item 7)

Test setup

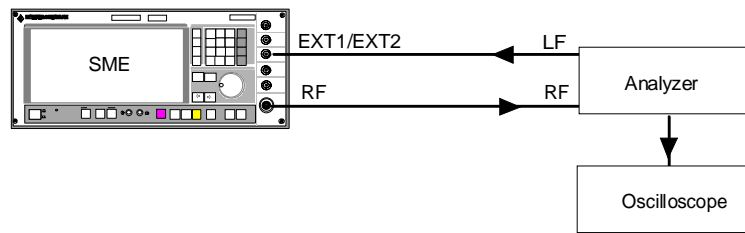

#### 5.1.1.2 Test System with Audio Analyzer

Test equipment

- Modulation analyzer (Section 5.1, item 15)
- Audio analyzer (Section 5.1, item 14)

Test setup

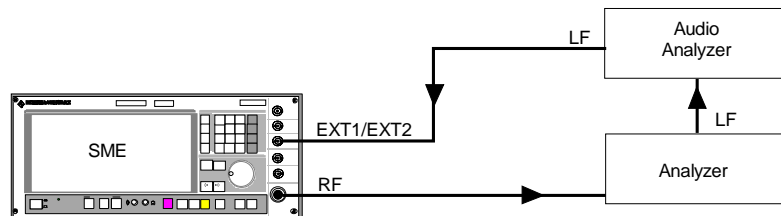

### 5.1.1.3 Test System for Broadband FM

Test equipment

- Second signal generator (Section 5.1, item 5)
- Mixer (Section 5.1, item 16)
- Sine-wave generator (Section 5.1, item 18)
- AC voltmeter (Section 5.1, item 19)
- Broadband FM demodulator (Section 5.1, item 20)
- RF attenuator pad (Section 5.1, item 21)
- Lowpass filter (Section 5.1, item 23)

Test setup

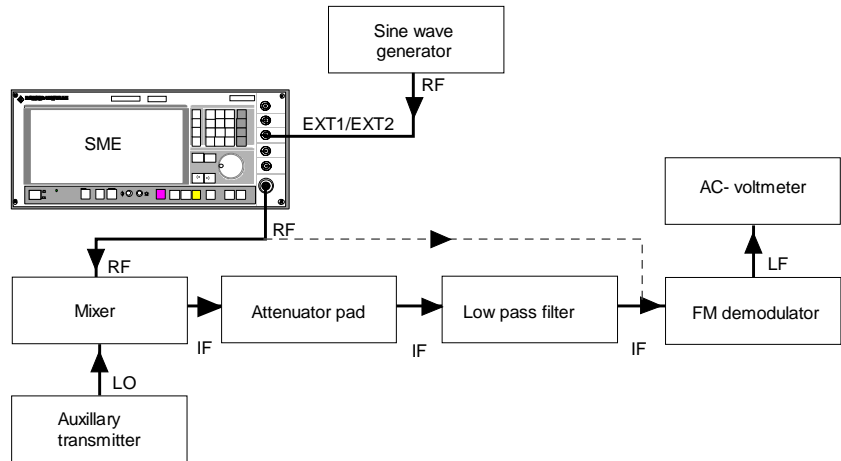

### 5.1.1.4 Test System for Pulse Modulation

Test equipment

- Second signal generator (Section 5.1, item 5)
- Oscilloscope (Section 5.1, item 7)
- Mixer (Section 5.1, item 16)
- Pulse generator (Section 5.1, item 17)
- RF attenuator pad (Section 5.1, item 21)
- Lowpass filter (Section 5.1, item 23)

Test setup

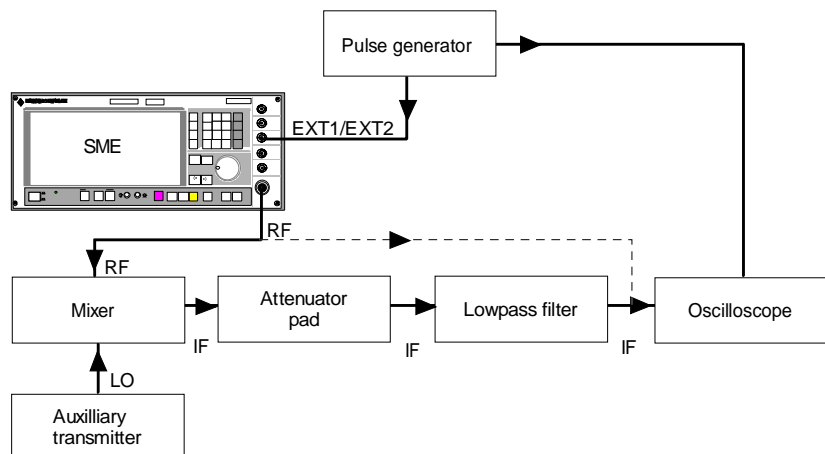

### 5.1.1.5 Test System for GFSK

- Test equipment
- Storage oscilloscope (Section 5.1, item 3)
  - Second signal generator (Section 5.1, item 5)
  - Mixer (Section 5.1, item 16)
  - Broadband FM demodulator (Section 5.1, item 20)
  - RF attenuator pad (Section 5.1, item 21)
  - Lowpass filter (Section 5.1, item 23)

Test setup

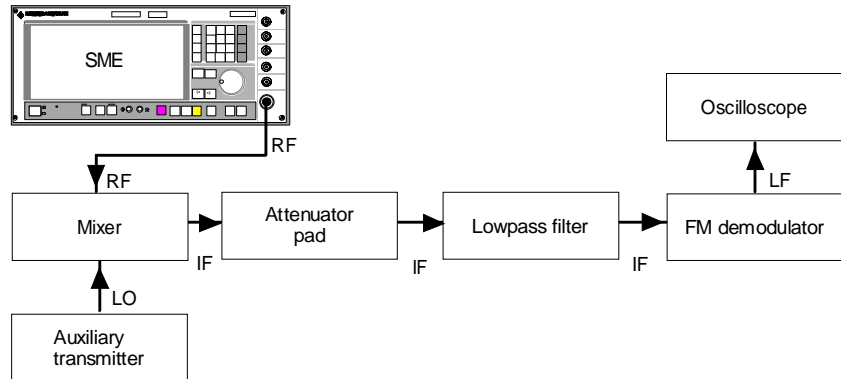

### 5.1.1.6 Test System Extension by Down Conversion

- Test equipment
- Second signal generator (Section 5.1, item 5)
  - Mixer (Section 5.1, item 16)
  - RF attenuator (Section 5.1, item 21)
  - RF attenuator (Section 5.1, item 26)
  - Lowpass (Section 5.1, item 23)

Test setup

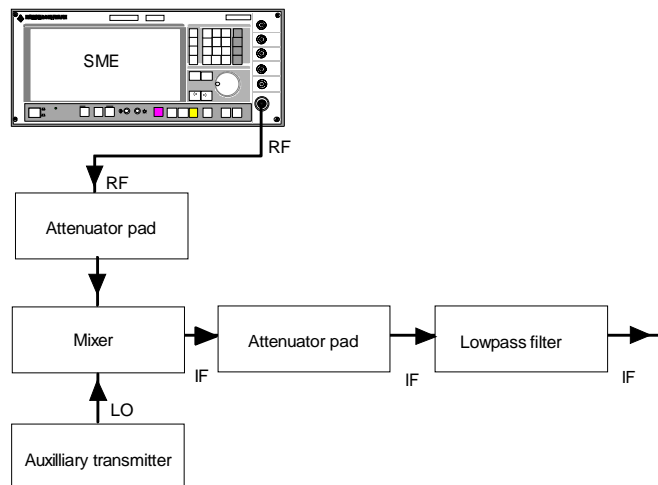

## 5.2 Test Procedure

The rated specifications of the generator are tested after the instrument has warmed up for at least 30 minutes and a total calibration has been carried out (c.f. Section 2.11.8, Calibration). This is the only way to make sure that the guaranteed data are observed.

The values in the following sections are not guaranteed; only the technical data in the data sheet are binding.

### 5.2.1 Display and Keyboard

Testing	Display	<ul style="list-style-type: none"> <li>➤ Switch on instrument. The basic menu is displayed after several seconds.</li> <li>➤ Rotate contrast control (left-hand potentiometer at the lower edge). The contrast is varied from dark to bright.</li> <li>➤ Rotate brightness control (right-hand potentiometer at the lower edge) The brightness of the background illumination is varied.</li> </ul>
	Keyboard	<ul style="list-style-type: none"> <li>➤ Press keys and check response at the display.</li> </ul>

### 5.2.2 Frequency Setting

Test equipment	Frequency counter (Section 5.1, item 1)
Test principle	The frequency setting is checked using a frequency counter whose reference frequency is synchronized with the one of the SME.
Measurement	<ul style="list-style-type: none"> <li>➤ Setting at the SME                             <ul style="list-style-type: none"> <li>- Test frequency unmodulated,</li> <li>- Level 0 dBm</li> </ul> </li> </ul> <p>The values measured must be exact within the frame of the counter resolution.</p>
Test frequencies recommended	see table 5-2

Table 5-2 shows the synthesis-dependent changeover limits. In order to fully test the function of the instrument, we recommend measurements at these range limits.

Table 5-2a Changeover limits of the SME

Range	from	to
Doubler1 (SME03\06) (SME03E)	1500.000 000 1 MHz 1500.000.000 2MHz	3000.000 000 0 MHz 2297.200 000 0 MHz
Doubler2 (SME06)	3000.000 000 1 MHz	6000.000 000 0 MHz
Synthesis octave	750.000 000 1 MHz	1500.000 000 0 MHz

Divider :2	375.000 000 1 MHz	750.000 000 0 MHz
Divider :4	187.500 000 1 MHz	375.000 000 0 MHz
Divider :8	93.750 000 1 MHz	187.500 000 0 MHz
Mixer range	0.001 000 0 MHz	93.750 000 0 MHz
Mixer range with a large deviation	0.001 000 0 MHz	130.700 000 0 MHz

Table 5-2b Changeover limits of the SME

Range			from	to
Lowpass filters OPU1	No	0	1045.600 000 1 MHz	1500.000 000 0 MHz
		1	750.000 000 1 MHz	1045.600 000 0 MHz
		2	522.800 000 1 MHz	750.000 000 0 MHz
		3	375.000 000 1 MHz	522.800 000 0 MHz
		4	261.400 000 1 MHz	375.000 000 0 MHz
		5	187.500 000 1 MHz	261.400 000 0 MHz
		6	130.700 000 1 MHz	187.500 000 0 MHz
		7	93.750 000 1 MHz	130.700 000 0 MHz
Bandpass filters OPU3 (SME03E/03/06) (SME03/06)	No.	1	1500.000 000 1 MHz	1885.200 000 0 MHz
		2	1885.200 000 1 MHz	2297.200 000 0 MHz
		3	2297.200 000 1 MHz	3000.000 000 0 MHz
Bandpass filters OPU6 (SME06)	Nr.	1	3000.000 000 1 MHz	3770.400 000 0 MHz
		2	3770.400 000 1 MHz	4594.400 000 0 MHz
		3	4594.400 000 1 MHz	6000.000 000 0 MHz
Oscillators SUM	Nr.	1	750.000 000 1 MHz	1100.000 000 0 MHz
		2	1100.000 000 1 MHz	1500.000 000 0 MHz
Rectifier	before mixer at output OPU1 at output OPU3 (SME03E) at output OPU3 (SME03) at output OPU6 (SME06)		0.001 000 0 MHz	9.362 500 0 MHz
			9.362 500 1 MHz	1500.000 000 0 MHz
			1500.000 000 1 MHz	2297.200 000 0 MHz
			1500.000 000 1 MHz	3000.000 000 0 MHz
			1500.000 000 1 MHz	6000.000 000 0 MHz

### 5.2.3 Settling Time

Test equipment

- Spectrum analyzer with video output (Section 5.1, item 2)
- Storage oscilloscope (Section 5.1, item 3)
- Controller (Section 5.1, item 4)

Test principle

The spectrum analyzer is operated as an edge demodulator with a 0-Hz span. A controller transmits starting and stop frequency via the IEC bus. The storage oscilloscope is connected to the video output of the analyzer and triggered by the positive edge on the EOI line of the IEC bus. If the controller switches over from the starting to the stop frequency, the settling procedure is displayed on the screen of the storage oscilloscope..

Test setup

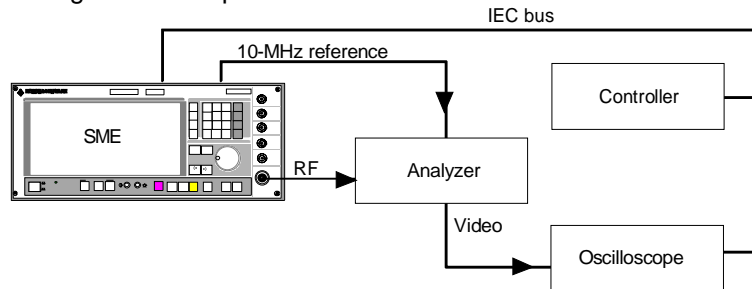

Preparing measurement

- Synchronize the reference frequencies of SME and analyzer.
- Establish IEC bus and RF connections.
- Connect storage oscilloscope to the video output of the analyzer.
- Apply trigger connection to the EOI-line (pin 5) of the IEC bus.
- Settings at the SME
  - Stop frequency unmodulated
  - Level 0 dBm
- Settings at the storage oscilloscope
  - Time base 2 ms/div
  - Sensitivity corresponding to the video output of the analyzer,
  - Trigger free-running with respect to calibration.
  - Settings at the spectrum analyzer
    - Reference level 5 dBm,
    - Amplitude scale 1 dB/div,
    - Resolution bandwidth to 3 kHz,
    - Video bandwidth 100 kHz,
    - Span 10 kHz
- Now increase the center frequency, starting from the stop frequency, until the visible filter edge runs through the central point of the screen.
- The span can now be reduced to 0 Hz and the frequency scale be calibrated at the (free-running) oscilloscope by means of steps of 100 Hz at the SME.

## Measurement

- Setting at the storage oscilloscope
  - Time base 2 ms/div
  - Sensitivity corresponding to the video output of the analyzer
  - Triggering externally by the positive edge at 1.5 V.
- Send the starting frequency first and then the stop frequency from the controller.
 

The settling curve is displayed on the screen of the oscilloscope triggered externally.  
Relative deviation from the rated frequency after 10 ms <math><1E-7</math>
- Repeat measurement with exchanged starting and stop frequencies.

## Recommended measuring frequencies

Starting frequency	Stop frequency
749 MHz	751 MHz
751 MHz	1101 MHz
93 MHz	1500 MHz
840 MHz	942 MHz
1350.2 MHz	1351.4 MHz
751 MHz	2200 MHz (SME03E)
751 MHz	3000 MHz (SME03)
751 MHz	6000 MHz (SME06)

## Quick-Basic program for the controller

```

CLS
iecadresse% = 28
CALL IBFIND("DEV1", generator%)
CALL IBPAD(generator%, iecadresse%)
iecterm% = &HA '
CALL IBEOS(generator%, iecterm% + &H800)
CALL IBWRT(generator%, "POW 0dBm")
DO
  INPUT "Start frequency in MHz";F1$
  INPUT "Stop frequency in MHz";F2$
  DO
    CALL IBWRT(generator%, "FREQ" + F1$ + "MHz")
    PRINT "frequency:";F1$; "MHz"
    DO '
      kbd$ = INKEY$
      LOOP UNTIL LEN(kbd$)
      SWAP F1$, F2$
    LOOP UNTIL kbd$ = CHR$(27) '
    INPUT "Repeat (y/n)"; w$
  LOOP UNTIL NOT UCASES$(w$) = "Y"
END

```

IEC-bus address of the SME (28)  
Open DEV1 and obtain access number  
Set IEC-bus address of the DEV1 to 28  
Set EOS to LINE FEED

Wait for key

Exit using ESCAPE

### 5.2.4 Reference Frequency

**Caution:** Allow the SME to warm up for at least 2 hours before measurement.

Test equipment	Frequency counter (Section 5.1, item 1)
Test setup	Connect a calibrated frequency counter to output REF (socket at the rear).
Measurement	<ul style="list-style-type: none"> <li>➤ Measure frequency.</li> </ul> <p>Relative frequency error in the rated temperature range with standard.....&lt;1E-6, per year of service period +2E-6 with option SM-B1.....&lt;1E-9, per year of service period +5E-8</p>

### 5.2.5 Harmonics Suppression/Subharmonics

**Note:** As subharmonics occur at frequencies >1.5 GHz, only SME03 and SME06 have to be tested for subharmonics.

Test equipment	Spectrum analyzer (Section 5.1, item 2)
Test setup	Connect the spectrum analyzer to the RF output of the SME.
Measurement	<ul style="list-style-type: none"> <li>➤ Settings at the SME02/03E/03/06             <ul style="list-style-type: none"> <li>- Test frequencies 5 kHz to 1500/2200/3000/6000 MHz, unmodulated</li> <li>- Level 10 dBm or 13 dBm.</li> </ul> </li> <li>➤ Check the harmonics suppression using the spectrum analyzer. Make sure that the spectrum analyzer is not overdriven.             <p>Harmonics level</p> <ul style="list-style-type: none"> <li>at 10 dBm .....max. -30 dBc</li> <li>at 13 dBm .....max. . - 26 dBc</li> </ul> </li> <li>➤ Measure the subharmonics using a spectrum analyzer. Make sure not to overdrive the spectrum analyzer (only for SME03/06).             <p>Level of subharmonics at</p> <ul style="list-style-type: none"> <li>Frequency settings &gt;1.5 GHz .....max. -40 dBc</li> <li>Frequency settings &gt;3.0 GHz .....max. -34 dBc</li> </ul> </li> </ul>



## 5.2.6 Suppression of Nonharmonics

Test equipment and setup See Section 5.2.5, Harmonics Suppression.  
The test level should be 8.1 dBm unmodulated.

Measurement Nonharmonics level with

Frequency settings $\leq$ 1.5 GHz .....	<-80 dBc
Frequency settings > 1.5 GHz (SME03/03E) .....	<-74 dBc
Frequency settings > 3.0 GHz (SME06) .....	<-68 dBc

Recommended settings at the spectrum analyzer

- Span 5 kHz,
- Resolution bandwidth 1 kHz,
- Video bandwidth 30 Hz,
- Synchronize reference frequencies of analyzer and test object.

Recommended test and search frequencies

Nonharmonics of the  
step synthesis

Setting at the SME	Search in the ratio
831.0 MHz	689.6 kHz
832.7 MHz	699.3 kHz
1044.5 MHz	598.8 kHz
1043.0 MHz	591.7 kHz
1139.6 MHz	518.1 kHz
1141.0 MHz	523.5 kHz
1457.5 MHz	917.4 kHz
1349.6 MHz	934.5 kHz
1444.0 MHz	826.4 kHz
1446.0 MHz	840.3 kHz
1430.5 MHz	751.9 kHz
1434.1 MHz	763.4 kHz

Mixer nonharmonics of the output part

Setting at the SME	Search at frequency
93.75 MHz	131.25 MHz
93.75 MHz	37.5 MHz
93.75 MHz	56.25 MHz
70.0 MHz	40.0 MHz

Nonharmonics of the summing loop

Setting at the SME	Search in the ratio
1412.9 MHz	300.0 kHz
1305.4 MHz	300.0 kHz
1197.9 MHz	300.0 kHz
1090.4 MHz	300.0 kHz
838.25 MHz	117,6 kHz
380 MHz	425.5 kHz
1495.59 MHz	15.59 MHz
1354.0625 MHz	14.2567 MHz
1354.0625 MHz	28.5133 MHz

### 5.2.7 SSB Phase Noise

Test equipment

- Second signal generator (Section 5.1 item 5),
- Phase noise test system, consisting of mixer with lowpass filter and preamplifier (Section 5.1 item 6),
- Oscilloscope (Section 5.1 item 7)
- Spectrum analyzer (Section 5.1 item 2).

Test principle

The two signal generators are set to the test frequency and synchronized with a phase offset of 90 deg (phase quadrature). Mixing to 0 Hz suppresses the RF carrier and due to the phase quadrature the mixer supplies a voltage corresponding to the phase difference between the input signals. This is measured by the LF spectrum analyzer and can be converted into SSB phase noise.

Test setup

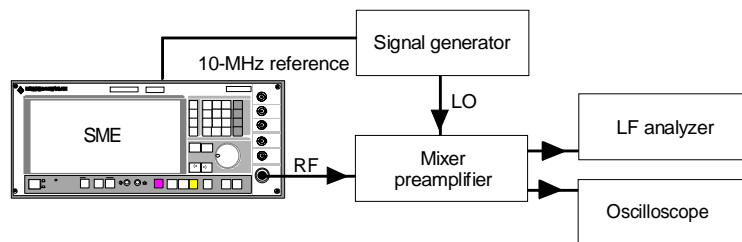

## Measurement

- Set the levels of the two signal generators according to the specifications of the mixer used (unmodulated)
- For calibration, set the preamplifier to 0 dB and detune a signal generator by 20 kHz. Measure and note down the reference value at 20 kHz at the analyzer.
- Cancel the detuning and make the phase quadrature. Call menu UTILITIES/PHASE to this effect. Observe the output voltage of the mixer at the oscilloscope and vary the phase until the voltage becomes 0.
- Set the preamplifier to 40 dB and read the noise voltage at the analyzer, normalized to a bandwidth of 1 Hz (noise level).

## Evaluation

- Subtract from the reference value and add 6 dB for the second side band measured (correlated) and 40 dB for the amplification switchover to the ratio found. If the signal-to-noise ratio of the second signal generator is not better than the one of the test object by at least 10dB, the noise component of the reference transmitter must be determined and subtracted as well.

**Example:**

Let the reference level be measured to be 12dBm. A noise level of -78dBm (1Hz) is determined at 20kHz. The difference is 90dB, in addition to the correction for the second side band (6dB) and the amplification switchover (40dB) there is a signal-to-noise ratio of 136dB or a noise level of -136dBc (dB with respect to the carrier power). If two identical signal transmitters have been used, the result must be decreased by 3dB for the (uncorrelated) noise power of the reference transmitter.

*The final result is then -139dBc.*

The following noise levels should be measured and/or not be exceeded:

Test frequency	Noise in 20-kHz ratio
6000 MHz	-110 dBc (only SME06)
3000 MHz	-116 dBc (only SME03/06)
2000 MHz	-120 dBc (only SME03E/03/06)
1000 MHz	-126 dBc
500 MHz	-132 dBc
250 MHz	-137 dBc
125 MHz	-140 dBc
< 93.75 MHz	-129 dBc

### 5.2.8 Broadband Noise

Test equipment	Broadband noise is measured using the test setup of 5.2.7 (SSB Phase Noise).
Test principle	Calibration is effected in the same way as in Section 5.2.7, SSB Phase Noise. For measurement, the signal generators are detuned until the difference frequency falls into the stop band of the lowpass filter (> 10 MHz). A 1-MHz section of the sum of the broadband noise powers of both signal generators is to be measured at the spectrum analyzer then, which corresponds to the carrier frequency offset from the difference frequency up to the difference frequency minus 1MHz. Due to the mirror inversion of the spectrum at the zero line, the power measured must be halved.
Measurement	<ul style="list-style-type: none"> <li>➤ Calibration see Section 5.2.7.</li> <li>➤ Increase the detuning to the measurement offset frequency (≥ 10MHz, recommended offset frequency 10MHz).</li> <li>➤ Set the preamplifier to 40dB and read the noise voltage at the analyzer at a center frequency of approx. 100kHz, normalized to a bandwidth of 1Hz (noise level).</li> </ul>
Evaluation	<ul style="list-style-type: none"> <li>➤ Subtract from the reference level and add 43dB for the amplification switchover and the mirror image. The measured value is the sum of the noise powers of both signal generators. If the signal-to-noise ratio of the second signal generator is not better than the one of the test object by at least 10dB, the noise component of the reference transmitter must be determined and subtracted as well. In the case of two identical transmitters, the correction is further 3dB.</li> </ul> <p style="margin-left: 40px;">Corrected measured value ..... ≤ -140 dBc</p>
Recommended test frequencies	see table 5-2.

### 5.2.9 Residual FM

**Note:** *The measurement of SSB phase noise usually makes a measurement of unwanted deviation superfluous as it is more sensitive.*

Test equipment	Test system 5.1.1.1
Measurement	<ul style="list-style-type: none"> <li>➤ Settings at the SME             <ul style="list-style-type: none"> <li>- 1GHz, unmodulated,</li> <li>- Level 8.1dBm.</li> </ul> </li> <li>➤ Settings at the analyzer             <ul style="list-style-type: none"> <li>- FM, RMS value</li> </ul> <p style="margin-left: 40px;">Unwanted deviation in the case of CCITT filtering 1Hz and with a measuring bandwidth of 30Hz to 23kHz ..... ≤ 4 Hz</p> </li> </ul>

### 5.2.10 Residual AM

Test equipment	Test system 5.1.1.1
Measurement	See Section 5.2.9, but demodulation AM Residual AM with a measuring bandwidth of 30 Hz to 23 kHz ..... $\leq 0.02\%$

### 5.2.11 Output Level

Test equipment	-Power meter (Section 5.1, item 8) - Precision attenuator (Section 5.1, item 9) - Spectrum analyzer (Section 5.1, item 2) - Low-noise preamplifier (Section 5.1, item 10)
----------------	--

#### Test Methods for Level in the Measuring Range of the Power Meter

Test setup	Connect power meter to the RF output socket.
Measurement	<ul style="list-style-type: none"> <li>➤ Setting at the SME           <ul style="list-style-type: none"> <li>- RF level to be measured (see below), unmodulated.</li> </ul> </li> <li>➤ Measure the level at output frequencies of 5 kHz to 1500 MHz (2200/3000/6000 MHz with SME03E/03/06). Deviation of the output level from the rated value at frequency <math>\leq 3</math> GHz ..... max. <math>\leq 1</math> dB at frequency <math>&gt; 3</math> GHz ..... max. <math>\leq 2</math> dB Frequency response at 0 dBm (difference between the lowest and the highest level) ..... max. <math>\leq 1</math> dB</li> </ul>
Recommended test level	13, 10, 8, 7.9, 5, 0, -5, -10, -20, -30 dBm

#### Test Methods for Low Levels

Test principle	Levels below the measuring range of the power meter can be carried out by means of a comparison measurement using a precision attenuator and a sensitive test receiver or spectrum analyzer.
Test setup	Connect a precision attenuator to the RF output of the SME and a spectrum analyzer with screened RF measurement cables to its output.

- Measurement
- Settings at the SME
    - Test frequency
    - Level 10 dBm, unmodulated
  - Setting at the analyzer
    - Test frequency
  - Setting at the attenuator
    - Attenuation 120 dB.
  - Read the level at the analyzer and note down as a reference value. It should be approx. -110 dBm. Select the measurement bandwidth small enough to ensure an exact reading.
  - Now repeat the measurement with the settings given in the table.  
 Deviation of the indication at the analyzer from the reference value, in each case .....max. 1dB

Settings

Level at the SME	Attenuation of the attenuator
10 dBm	120 dB
5 dBm	115 dB
0 dBm	110 dB
-10 dBm	100 dB
-30 dBm	80 dB
-50 dBm	60 dB
-70 dBm	40 dB
-90 dBm	20 dB
-110 dBm	0 dB

**Measurement of Lowest Levels**

**Caution:** No RF leakage of the components used is the prerequisite for a correct measurement

- Test setup
- Insert a low-noise preamplifier between SME and precision attenuator.
- Measurement
- Perform a subsequent calibration with a level already measured (-30dBm). This allows measuring levels up to the lower setting limit of the SME.

## 5.2.12 Output Reflection Coefficient

### Test equipment

- VSWR bridge (Section 5.1, item 11)
- VSWR directional coupler (Section 5.1, item 25) for SME06
- Second signal generator (Section 5.1, item 5)
- Spectrum analyzer (Section 5.1, item 2) .

### Test setup

**Note:** For test frequencies >3 GHz use a VSWR directional coupler instead of a VSWR bridge.  
The test port of the bridge or the directional coupler has to be screwed directly to the DUT.

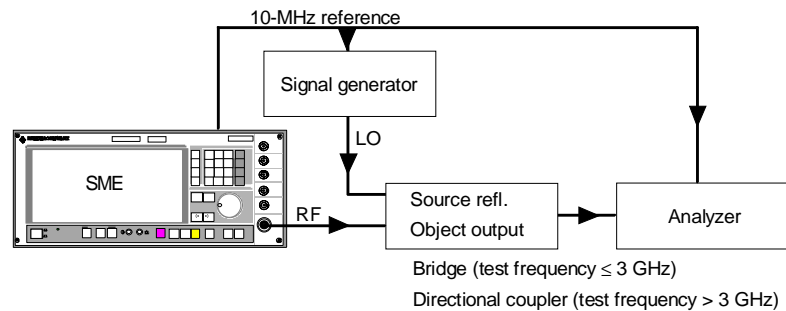

### Measurement

- Settings at the SME
  - Test level
  - Test frequency, unmodulated.
- Settings at the Spectrum analyzer
  - Test frequency
  - Test level
  - Resolution and video bandwidth 10kHz,
  - Span 0 Hz,
  - linear scale
  - Sweep time 30 ms.
- Settings at the second signal generator
  - Detune by 100 Hz compared to the test frequency,
  - first minimal level, unmodulated.
- At the spectrum analyzer, now bring the line indicated approx. into the center of the screen by varying the reference level and read and note down the level as a reference level.
- Screw off the bridge or the directional coupler from the SME and increase the level at the second signal generator until the reference level is measured again at the analyzer.

- Screw the bridge or the directional coupler onto the SME again.
- A more or less wavy line representing the VSWR of the SME is to be seen now at the spectrum analyzer. The VSWR is to be calculated from the maximal and the minimal voltage according to

$$VSWR = v_{max}/v_{min}$$

- VSWR with test levels ≤ 0 dBm, f ≤ 3 GHz ..... max. 1.5
- VSWR with test levels ≤ 0 dBm, f > 3 GHz ..... max. 2.0
- VSWR with test levels > 0 dBm ..... max. 2.0
- VSWR with test levels > 0 dBm, f > 5 GHz, with SM-B9 .... max. 2.5

Passive measurement of the VSWR with output levels of the SME below -30 dBm

- Settings at the second signal generator
  - Test frequency
  - Level 10 dBm.
- Screw off VSWR bridge or directional coupler from the test object and note down the level measured at the analyzer as a reference value.
- Screw on the bridge or directional coupler again and determine the new level at the analyzer.
- The output reflection coefficient r of the test object is the voltage ratio test level/reference level. It serves to determine the voltage standing wave ratio (VSWR) according to the formula

$$VSWR=(1+r)/(1-r)$$

### 5.2.13 Interrupt-free Level Setting (ATTEN FIXED)

Test equipment

Power meter (Section 5.1, item 8)

Test setup

Connect the power meter to the RF output of the SME.

Measurement

- Settings at the SME
  - 1000 MHz, unmodulated,
  - Level 8.0 dBm,
  - Select FIXED in the LEVEL/LEVEL ATTEN menu.
- Note down the level read at the power meter as a reference level or set the power meter to 0 dB for relative measurement.
- Now reduce the level in steps of 5 dB at the SME. The following deviations should not be exceeded:

Attenuation	Tolerance
-5 dB	±0.2 dB
-10 dB	±0.4 dB
-15 dB	±0.6 dB
-20 dB	±0.8 dB



### 5.2.14 Overvoltage Protection (SME02 and SME03 only)



**Caution:**

*SME06 is not protected against overvoltage. To prevent damages to the unit*

- *never apply a DC. voltage to the RF output connector*
- *never apply more than the maximum permissible RF power (30 dBm) to the RF output connector.*

Test equipment	<ul style="list-style-type: none"> <li>- Adjustable d.c. voltage source (Section 5.1, item 12)</li> <li>- Signal generator (Section 5.1, item 5)</li> <li>- Power amplifier (Section 5.1, item 13)</li> </ul>
Test setup	Connect an adjustable d.c. voltage source to the RF output socket of the SME via a 50-Ohm resistor or a signal generator with a subsequent power amplifier with a power output of more than 1 Watt.
Testing	<ul style="list-style-type: none"> <li>➤ Settings at the SME           <ul style="list-style-type: none"> <li>- 100 MHz, unmodulated,</li> <li>- Level -120 dBm.</li> </ul> </li> <li>➤ Apply the d.c. voltage via the 50-Ohm resistance. The overvoltage protection must respond at a voltage of &gt;4V and &lt;7V with both polarities.</li> <li>➤ Connect the signal generator to the RF output socket of the SME via the power amplifier and feed frequencies of up to 1500 MHz (in the case of SME03E/03 2200/3000 MHz).  The overvoltage protection must respond at a supplied RF power of 0.5 to 1W.</li> </ul>

### 5.2.15 Level Monitoring at Input EXT1

Test equipment	Test system 5.1.1.2
Test setup	Connect the generator output of the audio analyzer to external modulation input EXT1.
Testing	<ul style="list-style-type: none"> <li>➤ Setting at the SME           <ul style="list-style-type: none"> <li>- Select EXT1 in the MODULATION/AM/AM SOURCE menu. Gen. level under <math>0.98 \pm 0.01 V(v_{peak})</math> .....indication EXT1 LOW Gen. level over <math>1.02 \pm 0.01 V(v_{peak})</math> .....indication EXT1 HIGH Gen. level between 0.99 and <math>1.01 V(v_{peak})</math> ..... no indication</li> </ul> </li> </ul>

### 5.2.16 Modulation Depth of AM

Test equipment	Test system 5.1.1.1 Test system 5.1.1.6 (SME06)
Measurement	<ul style="list-style-type: none"> <li>➤ Settings at the SME           <ul style="list-style-type: none"> <li>- Level 0 dBm</li> <li>- Select LFGEN1 in the MODULATION/AM/AM SOURCE INT menu,</li> <li>- Modulation depth 0.1% to 80% (recommended values 30% and 80%)</li> <li>- Modulation frequency 1 kHz</li> </ul> </li> <li>➤ Vary the carrier frequency from 5 MHz to 1500 MHz (2200/3000/6000 MHz with SME03E/03/06). For recommended setting values, see table 5-2.</li> <li>➤ Read off the modulation depth at the modulation analyzer. Deviation of the modulation depth measured from the setting value n</li> </ul>

### 5.2.17 AM Frequency Response

Test equipment	Test system 5.1.1.2 Test system 5.1.1.6 (SME06)
Measurement	<ul style="list-style-type: none"> <li>➤ Settings at the SME           <ul style="list-style-type: none"> <li>- Level 0 dBm,</li> <li>- Select EXT1 in the MODULATION/AM/AM SOURCE menu,</li> <li>- Modulation depth 60%.</li> </ul> </li> <li>➤ Vary the carrier frequency from 5kHz to 1500MHz (2200/3000/6000MHz with SME03E/03/06). For recommended setting values, see table 5-2.</li> <li>➤ Setting at the audio analyzer           <ul style="list-style-type: none"> <li>- Generator level 1 V(u<sub>peak</sub>).</li> </ul> </li> <li>➤ Determine the modulation frequency response (difference between the highest and the lowest modulation depth) by varying the generator frequency. Modulation frequency response from 20 Hz to 50 kHz ..... max.1dB</li> </ul>

**Note:** If option SM-B2 LF generator is fitted, LFGEN2 can be selected in the MODULATION/AM/AM SOURCE menu and the test frequency be set using the internal generator for this measurement.

### 5.2.18 AM Distortion Factor

Test equipment	Test system 5.1.1.1. Test system 5.1.1.6 (SME06)
Measurement	<ul style="list-style-type: none"> <li>➤ Settings at the SME           <ul style="list-style-type: none"> <li>- Level 0 dBm</li> <li>- Select LFGEN1 in the MODULATION/AM/AM SOURCE INT menu,</li> <li>- Modulation depth 30%</li> <li>- Modulation frequency 1 kHz.</li> </ul> </li> <li>➤ Vary the carrier frequency from 1 MHz to 1500 MHz (2200/3000/6000 MHz with SME03E/03/06). For recommended setting values, see table 5-2.</li> <li>➤ Read off the distortion factor at the modulation analyzer. Distortion factor ..... max. 1%</li> <li>➤ Repeat measurement with an AM of 80%. Distortion factor ..... max. 2%</li> </ul>

### 5.2.19 Residual PhiM with AM

Test equipment	Test system 5.1.1.1. Test system 5.1.1.6 (SME06)
Measurement	<ul style="list-style-type: none"> <li>➤ Settings at the SME           <ul style="list-style-type: none"> <li>- Various test frequencies (for recommended setting values, see table 5-2)</li> <li>- Level 0 dBm</li> <li>- Select LFGEN1 in the MODULATION/AM/AM SOURCE INT menu,</li> <li>- Modulation depth 30%</li> <li>- Modulation frequency 1 kHz.</li> </ul> </li> <li>➤ Measure the phase modulation resulting by means of a 23-kHz lowpass filter and peak weighting at the modulation analyzer. Unwanted modulation with frequencies <math>\leq 3</math> GHz..... max. 0.1 rad Unwanted modulation with frequencies <math>&gt; 3</math> GHz..... max. 1.0 rad</li> </ul>

**5.2.20 Level Monitoring at Input EXT2 (Option SM-B5)**

Test equipment	Test system 5.1.1.2
Test setup	Connect the generator output of the audio analyzer to external modulation input EXT2.
Testing	<ul style="list-style-type: none"> <li>➤ Setting at the SME</li> <li>- Select EXT2 in the MODULATION/FM/FM1 SOURCE menu.</li> <li>Gen. level under <math>0.98 \pm 0.01 V(u_{peak})</math> .....indication EXT2 LOW</li> <li>Gen. level over <math>1.02 \pm 0.01 V(u_{peak})</math> .....indication EXT2 HIGH</li> <li>Gen. level 0,99 to 1,01 <math>V(u_{peak})</math> ..... no indication</li> </ul>

**5.2.21 FM Deviation Setting**

Test equipment	Test system 5.1.1.1
Measurement	<ul style="list-style-type: none"> <li>➤ Settings at the SME             <ul style="list-style-type: none"> <li>- RF 200 MHz</li> <li>- Level 0 dBm</li> <li>- Select LFGEN1 in the MODULATION/FM/FM1 SOURCE menu,</li> <li>- Modulation frequency</li> <li>- Hub 300 Hz to 250 kHz (see below).</li> </ul> </li> <li>➤ Read off the FM deviation at the modulation analyzer.              Deviation of the deviation measured from the setting value              ..... max. 3 % of the indication +20 Hz</li> </ul>
Recommended setting values	300 Hz ,1 , 3, 10, 30, 100 and 250 kHz.

## 5.2.22 FM Frequency Response

### 5.2.22.1 FM Frequency Response up to 100 kHz

- Test equipment                      Test system 5.1.1.2
- Measurement
- Settings at the SME
    - Test frequency 100 MHz
    - Level 0 dBm
    - Select EXT1 in the MODULATION/FM/FM1 SOURCE menu,
    - Deviation 50 kHz .
  - Setting at the audio analyze
    - Generator level 1 V( $V_{peak}$ ) .
  - Determine the modulation frequency response (difference between the highest and lowest modulation depth) by varying the generator frequency of the audio analyzer from 10Hz to 100kHz.  
Modulation frequency response ..... max. 0.5 dB
  - Repeat measurement when frequency is fed at socket EXT2 and with setting MODULATION/FM/FM2 SOURCE EXT2.

**Note:** If option SM-B2 LF generator is fitted, LFGEN2 can be selected in the MODULATION/FM FM2 SOURCE menu and the test frequency be set using the internal generator for this measurement.

### 5.2.22.2 FM Frequency Response up to 2 MHz

- Test equipment                      Test system 5.1.1.3  
Test system 5.1.1.6 (SME06)
- Measurement
- Setting at the SME
    - Select EXT1 in the MODULATION/FM/FM1/SOURCE menu.
  - Vary the frequency from 10Hz to 2 MHz and measure the modulation frequency response (difference between highest and lowest modulation depth) using an AC voltmeter at the sine-wave generator.  
Modulation frequency response ..... max. 3 dB
  - Repeat measurement when frequency is fed at socket EXT2 and with setting MODULATION/FM/FM2 SOURCE EXT2.

Settings recommended

<b>F (RF)</b>	50 MHz	750.1 MHz	1099 MHz	1101 MHz	1500 MHz	3000 MHz	6000 MHz
<b>Deviation</b>	125 kHz	250 kHz	250 kHz	250 kHz	250 kHz	250 kHz	250 kHz
<b>Mixer</b>		X	X	X	X	X	X
<b>F (LO)</b>		800.1 MHz	1149 MHz	1151 MHz	1550 MHz	2950 MHz (SME03/06)	5950 MHz (SME06)

**5.2.23 FM Distortion Factor**

Test equipment	Test system 5.1.1.1
Measurement	<ul style="list-style-type: none"> <li>➤ Settings at the SME             <ul style="list-style-type: none"> <li>- Carrier frequency 250 MHz</li> <li>- Level 0 dBm</li> <li>- Select INT in the MODULATION/FM/FM1 SOURCE menu,</li> <li>- Deviation 62.5 kHz</li> <li>- Modulation frequency 1 kHz.</li> </ul> </li> <li>➤ Read off distortion factor at the modulation analyzer. Distortion factor ..... max. 0.5%</li> </ul>

**5.2.24 FM Preemphasis**

Test equipment	Test system 5.1.1.1
Measurement	<ul style="list-style-type: none"> <li>➤ Settings at the SME             <ul style="list-style-type: none"> <li>- Carrier frequency 100 MHz</li> <li>- Select LFGEN1 in the MODULATION/FM/FM1 SOURCE menu,</li> <li>- Deviation 25 kHz.</li> </ul> </li> <li>➤ Read off the deviation at the modulation analyzer and note down as a reference value with a modulation frequency of 100 Hz.</li> <li>➤ Switch on preemphasis 50 μs at the SME and at the modulation analyzer and increase the modulation frequency to 15 kHz. Deviation of the deviation measured now from the reference value &lt; 5%</li> <li>➤ Repeat measurement with a preemphasis of 75 μs.</li> </ul>

**5.2.25 Residual AM with FM**

Test equipment	Test system 5.1.1.1
Measurement	<ul style="list-style-type: none"> <li>➤ Settings at the SME             <ul style="list-style-type: none"> <li>- Various test frequencies &gt;10 MHz (for recommended settings, see table 5-2)</li> <li>- Level 0 dBm,</li> <li>- Select LFGEN1 in the MODULATION/FM/FM1 SOURCE menu,</li> <li>- Deviation 40 kHz ,</li> <li>- Modulation frequency 1 kHz.</li> </ul> </li> <li>➤ Measure the amplitude modulation resulting by means of a 23-kHz lowpass filter and peak weighting at the modulation analyzer. Unwanted modulation measured..... max. 0.1%</li> </ul>

### 5.2.26 Carrier frequency Deviation with FM

Test equipment	Test system 5.1.1.1
Measurement	<ul style="list-style-type: none"> <li>➤ Settings at the SME           <ul style="list-style-type: none"> <li>- 400 MHz</li> <li>- Level 0 dBm</li> <li>- Select LFGEN1 in the MODULATION/FM/FM1 SOURCE menu,</li> <li>- Deviation 0 kHz.</li> </ul> </li> <li>➤ Setting at the modulation analyzer           <ul style="list-style-type: none"> <li>- Counter function</li> </ul> </li> <li>➤ Observe change when switching on and off FM. Frequency deviation when switching on FM..... &lt; 50 Hz</li> <li>➤ Increase the deviation at the SME to 200 kHz. Frequency deviation when switching on FM..... &lt; 2050 Hz.</li> </ul>

### 5.2.27 FM Stereo Modulation

Test equipment	Test system 5.1.1.1
Test setup	Connect the stereo coder output of the modulation analyzer with socket EXT1 of the SME.
Measurement	<ul style="list-style-type: none"> <li>➤ Settings at the SME           <ul style="list-style-type: none"> <li>- Carrier frequencies 10.7 MHz and 85 MHz to 108 MHz</li> <li>- Select EXT1, DC coupled, in the MODULATION/FM/FM1 SOURCE menu,</li> <li>- Deviation 46 kHz.</li> </ul> </li> <li>➤ Setting at the stereo coder           <ul style="list-style-type: none"> <li>- Set the level such that neither EXT1 HIGH nor EXT1 LOW is indicated.</li> </ul> </li> <li>➤ Modulate both channels with 1 kHz, determine the distortion factor of both channels using the distortion meter in the modulation analyzer. Distortion factor ..... &lt; 0.1%</li> <li>➤ Switch over deviation measurement to relative measurement and operate both channels without a signal.</li> <li>➤ Measure the signal to noise ratio in both channels according to CCIR. The unweighted and weighted signal to noise ratio must be more than 76 dB.</li> <li>➤ Modulate only one channel with 1 kHz. Measure the crosstalk modulation in the unmodulated channel. It should be more than 50 dB under the reference value of the wanted modulation.</li> </ul>

### 5.2.28 PhiM Deviation Setting

Test equipment	Test system 5.1.1.1
Measurement	<ul style="list-style-type: none"> <li>➤ Settings at the SME             <ul style="list-style-type: none"> <li>- Carrier frequency 1000 MHz</li> <li>- Level 0 dBm</li> <li>- Select INT in the MODULATION/PM/PM1 SOURCE menu,</li> <li>- Deviation 0.03 to 10 rad</li> <li>- Modulation frequency 1 kHz.</li> </ul> </li> <li>➤ Read off PhiM deviation at the modulation analyzer.              Deviation of the deviation measured from the setting value              .....max. 3% of the indication +0.01 rad</li> </ul>
Recommended setting values	0.03, 0.1, 0.3, 1, 3, 10 rad

### 5.2.29 PhiM Frequency Response

**Note:** If option SM-B2 LF generator is fitted, LFGEN2 can also be selected in the MODULATION/PM PM2 SOURCE menu and the test frequency be set using the internal generator for this measurement.

Test equipment	Test system 5.1.1.2
Measurement	<ul style="list-style-type: none"> <li>➤ Settings at the SME             <ul style="list-style-type: none"> <li>- Carrier frequency 1000 MHz,</li> <li>- Level 0 dBm</li> <li>- Select EXT1, AC coupled, in the MODULATION/PM/PM1 SOURCE menu,</li> <li>- Select EXT1, AC coupled, in the MODULATION/PM/PM1 5 rad.</li> </ul> </li> <li>➤ Setting at the audio analyzer             <ul style="list-style-type: none"> <li>- Generator level 1 V(<math>v_{peak}</math>).</li> </ul> </li> <li>➤ Determine the modulation frequency response (difference between t               Modulation frequency response 10 Hz to 100 kHz..... max. 3 dB</li> <li>➤ Repeat measurement using setting PM2 SOURCE EXT2.</li> </ul>



### 5.2.30 PhiM Distortion Factor

Test equipment	Test system 5.1.1.1
Measurement	<ul style="list-style-type: none"> <li>➤ Settings at the SME           <ul style="list-style-type: none"> <li>- Carrier frequency 1 GHz</li> <li>- Level 0 dBm</li> <li>- Select INT in the MODULATION/PM/PM1 SOURCE menu,</li> <li>- Deviation 5 rad</li> <li>- Modulation frequency 1 kHz.</li> </ul> </li> <li>➤ Read off the distortion factor at the modulation analyzer. Distortion factor ..... max. 1%</li> </ul>

### 5.2.31 Internal Modulation Generator

Test equipment	Audio analyzer (Section 5.1, Pos. 14)
Test setup	Connect an audio analyzer to socket LF of the SME to test the internal modulation generator.
Measurement	<ul style="list-style-type: none"> <li>➤ Settings at the SME           <ul style="list-style-type: none"> <li>- Select LFGEN1 in the LF OUTPUT/SOURCE menu,</li> <li>- Level 1 V.</li> <li>- subsequently all 4 frequencies of the internal generator.</li> </ul> </li> <li>➤ Read off the actual frequency at the audio analyzer. Deviation compared to the rated value ..... &lt; 3%</li> <li>➤ Read off output voltage at the audio analyzer. Output voltage ..... 990 to 1010 mV (peak value)</li> </ul>

### 5.2.32 Pulse Modulation (Option SM-B3/B8/B9)

#### 5.2.32.1 ON/OFF - Ratio

Test equipment	- Spectrum analyzer (Section 5.1, item 2) - Pulse generator (Section 5.1, item 17)
Test setup	To determine the ON/OFF ratio, connect a spectrum analyzer to the RF output socket of the SME and a pulse generator to socket PULSE at the rear panel of the SME.
Measurement	<ul style="list-style-type: none"> <li>➤ Setting at the SME             <ul style="list-style-type: none"> <li>- Select EXT in the MODULATION/PULSE/SOURCE menu.</li> </ul> </li> <li>➤ Determine the output level of the SME with a present "high" and "low" signal with various carrier frequencies Difference of the output level with a "high" and "low" signal .....&gt;80 dB</li> </ul>

#### 5.2.32.2 Dynamic Characteristics

Test equipment	Test system 5.1.1.4
Measurement	<ul style="list-style-type: none"> <li>➤ Simultaneously display the input signal from the pulse generator and the (down-converted) output signal on the dual-trace oscilloscope (triggering on the input signal).</li> <li>➤ Settings at the pulse generator             <ul style="list-style-type: none"> <li>- Square-wave pulse sequence at a frequency of approx. 10 MHz, TTL level.</li> </ul> </li> <li>➤ Settings at the SME             <ul style="list-style-type: none"> <li>- Carrier frequencies &gt; 50 MHz</li> <li>- with option SM-B3: level 10 dBm.</li> <li>- with option SM-B8: level 9 dBm.</li> <li>- with option SM-B9: level 8 dBm.</li> </ul> </li> <li>➤ With carrier frequencies &gt; 50 MHz, use mixer and set an IF of approx. 50 MHz using the auxiliary transmitter.</li> <li>➤ Evaluate the modulated RF signal at the oscilloscope. Rising time = the time between 10% and 90% of the RF amplitude Fall time = the time between 90% and 10% of the RF amplitude Pulse delay time = the time between 50% of the input pulse amplitude and 50% of the RF amplitude Rising time..... &lt; 10 ns Fall time ..... &lt; 10 ns Pulse delay time ..... &lt; 70 ns</li> </ul>

## 5.2.33 GFSK Modulation (Option SME-B11)

### 5.2.33.1 Spectrum

#### Operating Mode internal

##### Test equipment

- Spectrum analyzer (Section 5.1, item 2)
- D.c. voltage source (Section 5.1, item 12)
- Pulse generator (Section 5.1, item 17)

##### Test setup

Connect spectrum analyzer to the RF output of the SME.

##### Measurement

- Settings at the SME
  - Carrier frequency 945 MHz,
  - Level 0 dBm,
 in menu DIGITAL MOD/GFSK
  - SOURCE PRBS
  - PRBS 23 bit
  - SELECT STANDARD DECT
- Settings at the analyzer
  - Reference level 0 dBm,
  - Span 5 MHz
  - Center frequency 945 MHz,
  - Resolution bandwidth 30 kHz,
  - Video bandwidth 30 Hz.

A spectrum according to Fig. 5-1 must be visible at the spectrum analyzer.

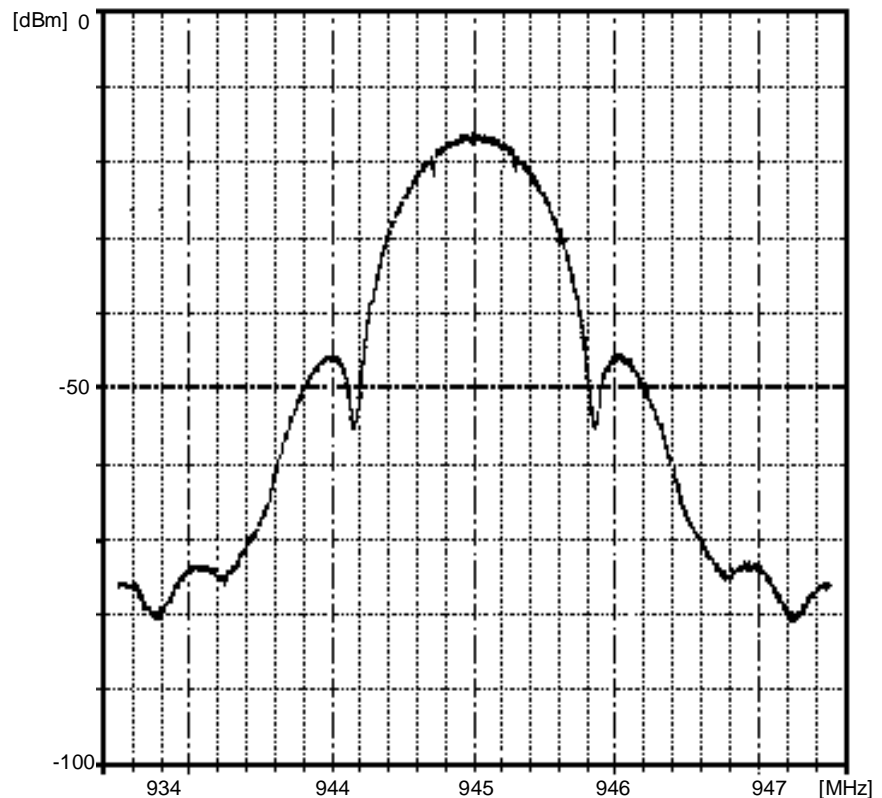

Fig. 5-1 Spectrum with GFSK

The signal level with respect to the level at a center frequency as a function of the offset frequency must be as follows:

Offset frequency	Level
835 kHz	-40 dB $\pm$ 3 dB
990 kHz	-30 dB $\pm$ 2 dB
1890 kHz	-58 dB $\pm$ 4 dB

**Operating Mode External**

Test equipment

- Spectrum analyzer (Section 5.1, item 2)
- D.c. voltage source (Section 5.1, item 12)
- Pulse generator (Section 5.1, item 17)

Test setup

Connect spectrum analyzer to the RF output of the SME. Connect the square-wave generator to the CLOCK input and the d.c. voltage source to the DATA input of the SME.

Measurement

- Setting at the SME
  - In menu DIGITAL MOD/GFSK/SOURCE EXT
- Settings at the pulse generator
  - Frequency 1152 kHz,
  - TTL level.
- Settings at the Analyzer
  - Set resolution and video bandwidth to COUPLING DEFAULT.

If a "LOW" level at the DATA input is applied, the center frequency should be 288  $\pm$ 10 kHz under the unmodulated carrier frequency, with "HIGH" level they should exceed the frequency by the same amount.

5.2.33.2 Deviation Error

Test equipment

Test system 5.1.1.5

Measurement

- Adjust the d.c. voltage at the FM demodulator output to  $0\text{ V} \pm 10\text{ mV}$  by means of a fine adjustment of the carrier or LO frequency with GFSK modulation switched off.
- Adjust the carrier frequency to 253.4 kHz offset to the above adjustment at the test object, measure the voltage at the FM demodulator output and note down as  $U_{ref}$ .
- Set the original carrier frequency again.
- Now switch on the modulation at the test object again using SOURCE DATA and enter a "LOW-HIGH sequence" ("01") using the list editor with DATA and BURST.
  - Square-wave signal at the DATA output ..... HC level  
..... frequency 576 kHz  $\pm 0.1\%$
  - Square-wave signal at the BURST output..... HC level  
..... frequency 576 kHz  $\pm 0.1\%$
  - Square-wave signal at the CLOCK output.....HC level  
..... frequency 1152 kHz  $\pm 0.1\%$
  - Diagnostic voltage at test point 301 .....  $6.3 \pm 1\text{ V}$

After 10 average sweeps an almost sinusoidal signal must be measured at the digital oscilloscope whose peak voltage must be  $V_{ref} \pm 7\%$ .
- Now enter the sequence "1111111011111111" using the list editor.
  - After 10 average sweeps a pulse signal must be measured at the digital oscilloscope whose voltage peak is about  $V_{ref} \pm 7\%$ .
- Enter the sequence "00000000111111111" using the list editor.
  - After 10 average sweeps a square-wave signal with an amplitude of  $1.136 \times V_{ref} \pm 3\%$  must be measured at the digital oscilloscope whose overshoot must be smaller than 5%.

Recommended settings for the measurement using the digital oscilloscope

F (RF)	50 MHz	750.1 MHz	1099 MHz	1101 MHz	1500 MHz	2200 MHz	3000 MHz	6000 MHz
Mixer		x	x	x	x	x	x	x
F (LO)		800.1 MHz	1149 MHz	1151 MHz	1550 MHz	2250 MHz (SME03E/03/06)	2950 MHz (SME03/06)	5950 MHz (SME06)

## 5.2.34 QPSK Modulation

### 5.2.34.1 Spectrum

- Caution:**
- The LEVEL-PRESET calibration (see service manual, stock no. 1039.1856.24) must be carried out before this measurement.
  - The delay adjustment for QPSK (see service manual, stock no. 1039.1856.24) should be checked and renewed if necessary before the measurement.

Test equipment                      Spectrum analyzer (Section 5.1, item 2)

Test setup                              Connect spectrum analyzer to the RF output socket of the SME.

- Measurement
- Settings at the SME
    - Carrier frequency 836 MHz, in the case of SME03/06 1513 MHz
    - Level 0 dBm, in menu DIGITAL MOD/QPSK
    - SOURCE PRBS,
    - PRBS 23 bit,
    - SELECT STANDARD NADC
  - Settings at the spectrum analyzer
    - Center frequency 836 MHz, with SME03/06 1513 MHz,
    - Span 300 kHz,
    - Resolution bandwidth 3 kHz,
    - Video bandwidth 100 Hz.

A spectrum according to Fig. 5-2 must be visible at the spectrum analyzer which adheres to the tolerances in the following table (The reference level is at the center frequency):

Offset frequency	Level
0 kHz	0 dB (reference)
30 to 50 kHz	< -40 dB
> 50 kHz	< -50 dB

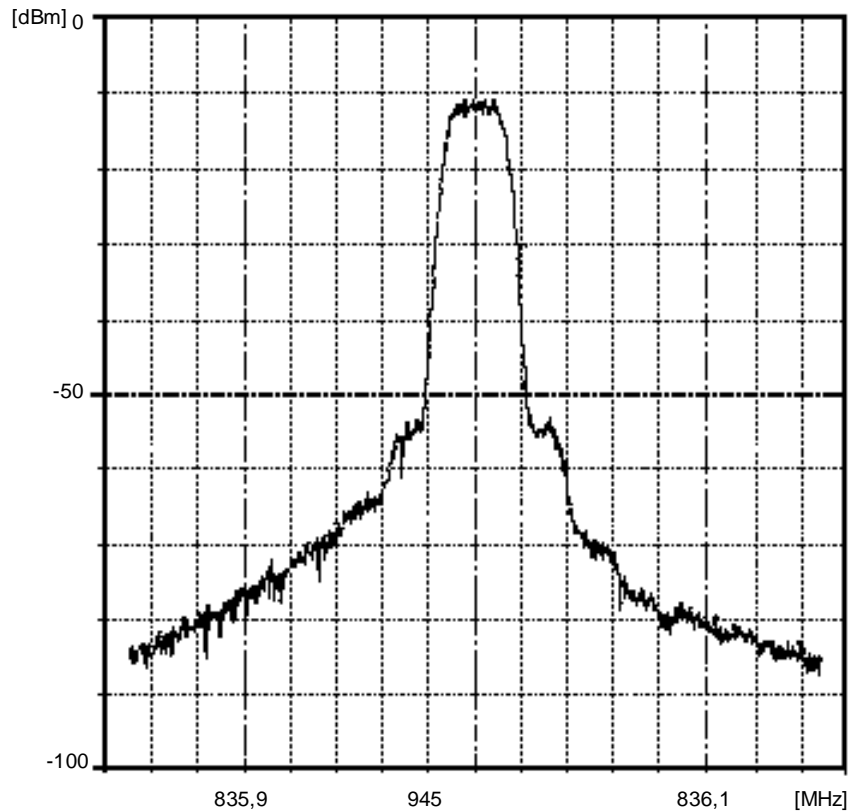

Fig. 5-2 Spectrum with QPSK

### 5.2.34.2 Vector Error (NADC Standard IS-54)

Test equipment	FSEA with option FSE-B7 (Section 5.1, item 23)
Test setup	Connect FSEA to the RF output socket of the SME
Measurement	<ul style="list-style-type: none"> <li>➤ Settings at the SME           <ul style="list-style-type: none"> <li>- Carrier frequency 900 MHz,</li> <li>- Level 7 dBm,</li> </ul>           in menu DIGITAL MOD/QPSK           <ul style="list-style-type: none"> <li>- SOURCE PRBS,</li> <li>- PRBS 23 bit,</li> <li>- SELECT STANDARD NADC .</li> </ul> </li> <li>➤ Settings at the FSE           <ul style="list-style-type: none"> <li>- PRESET</li> <li>- CENTER 900 MHz</li> <li>- REF 10 dBm</li> <li>- MODE VECTOR ANALYZER</li> <li>- DIGITAL STANDARDS NADC ENTER</li> <li>- TRIGGER FIND BURST OFF</li> <li>- MODE MEAS RESULTS</li> <li>- SYMB TABLE/ERRORS</li> </ul> </li> </ul> <p>RMS vector error ..... &lt;2.5% (1.3% typically)</p>

### 5.2.35 GMSK Modulation

#### 5.2.35.1 Spectrum

- Test equipment                      Spectrum analyzer (Section 5.1, item 2)
- Test setup                              Connect the spectrum analyzer to the RF output socket of the SME.
- Measurement
- Settings at the SME
    - Carrier frequency 900 MHz,
    - Level 0 dBm
 in menu DIGITAL MOD/GMSK
    - SOURCE PRBS
    - PRBS 23 bit
    - SELECT STANDARD GSM.
  - Settings at the spectrum analyzer
    - Center frequency 900 MHz,
    - Span 1 MHz,
    - Resolution bandwidth 10 kHz,
    - Video bandwidth 10 Hz.
- A spectrum according to Fig. 5-3 must be visible at the spectrum analyzer.

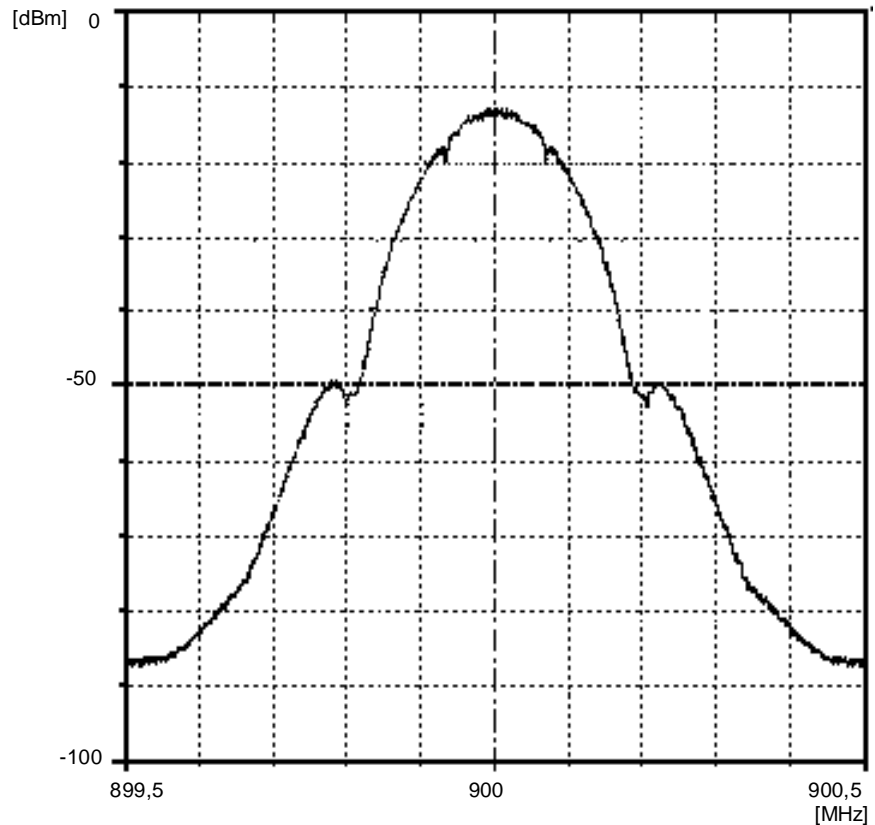

Fig. 5-3 Spectrum with GMSK



The signal level with respect to the level at a center frequency as a function of the offset frequency must adhere to the following tolerances

Offset frequency	Level
50 kHz	-2 ±1 dB
100 kHz	-8.6 dB ±2 dB
150 kHz	-20 dB ±3 dB
220 kHz	-36 dB ±3 dB
300 kHz	-52 dB ±3 dB

### 5.2.35.2 Phase Error

Test equipment

FSEA with option FSE-B7 (Section 5.1, item 23)

Test setup

Connect FSEA to the RF output socket of the SME

Measurement

- Settings at the SME
  - Carrier frequency 890.2 MHz,,
  - Level 13 dBm,
 in menu DIGITAL MOD/GMSK
  - SOURCE DATA
  - SELECT STANDARD GSM
  - LEVEL ATTEN 60 dB
  - LEV ATT MODE GSM SLOPE.

- Enter the following bit pattern using the list editor for DATA:

```
Bit no.: 001 002 003 004 005 006 007 008 009 010
Contents: 1 1 1 1 1 1 1 1 0 0
```

```
Bit no.: 011 012 013 014 015 016 017 018 019 020
Contents: 0 0 1 0 0 1 0 1 1 1
```

```
Bit no.: 021 022 023 024 025 026 027 028 029 030
Contents: 1 0 1 0 0 1 0 1 1 1
```

```
Bit no.: 031 032 033 034 035 036 037 038 038 040
Contents: 0 1 0 0 1 0 1 0 0 1
```

```
Bit no.: 041 042 043 044 045 046 047 048 049 050
Contents: 0 1 0 1 0 1 0 0 0 0
```

```
Bit no.: 051 052 053 054 055 056 057 058 059 060
Contents: 1 1 1 0 0 1 1 1 1 0
```

```
Bit no.: 061 062 063 064 065 066 067 068 069 070
Contents: 1 0 0 1 0 1 0 1 1 0
```

```
Bit no.: 071 072 073 074 075 076 077 078 079 080
Contents: 0 1 0 0 1 0 1 1 1 0
```

Bit no.:	081	082	083	084	085	086	087	088	089	090
Contents:	0	0	0	1	0	0	0	1	0	0
Bit no.:	091	092	093	094	095	096	097	098	099	100
Contents:	1	0	1	1	1	1	1	0	1	0
Bit no.:	101	102	103	104	105	106	107	108	109	110
Contents:	0	1	0	0	1	1	0	0	0	1
Bit no.:	111	112	113	114	115	116	117	118	119	120
Contents:	0	1	0	0	0	0	1	0	0	1
Bit no.:	121	122	123	124	125	126	127	128	129	130
Contents:	0	0	1	1	0	1	1	0	1	0
Bit no.:	131	132	133	134	135	136	137	138	139	140
Contents:	1	0	0	0	1	1	1	0	1	0
Bit no.:	141	142	143	144	145	146	147	148	149	150
Contents:	1	1	0	0	1	0	1	1	0	1
Bit no.:	151	152	153	154	155	156	157	158	158	160
Contents:	0	0	0	0	0	0	1	1	1	1
Bit no.:	161 ... 1250									
Contents:	111...									

- For LEV ATT, enter the following bit pattern:

Bit 1 to 8 must be "1".  
 Bit 9 to 159 must be "0".  
 Bit 160 to 1250 must be "1".

- Settings at the FSE

- PRESET
- CENTER 890.2 MHz
- REF 20 dBm
- MODE VECTORANALYZER
- MARKER SEARCH SUM MKR ON

RMS phase error) ..... <1° (0.7° typically).  
 Peak phase error) ..... <3° (2.7° typically).



**5.2.37.2 Frequency Response**

Test equipment	AC voltmeter (Abschnitt 5.1, Pos. 19)
Test setup	Connect AC voltmeter to the LF socket of the SME.
Measurement	<ul style="list-style-type: none"> <li>➤ Settings at the SME</li> <li style="padding-left: 20px;">In Menu LF OUTPUT</li> <li style="padding-left: 20px;">- SOURCE LFGEN2,</li> <li style="padding-left: 20px;">- Vary LFGEN2 FREQUENCY from 10 Hz to 500 kHz.</li> <li style="padding-left: 20px;">Frequency response (difference between the highest and lowest level) .....</li> <li style="padding-left: 20px;">.....up to 100 kHz &lt; 0.3 dB</li> <li style="padding-left: 20px;">.....up to 500 kHz &lt;0.5 dB</li> </ul>

**Note:** *The setting time is a mere time the computer requires and thus needs not to be remeasured.*

**5.2.38 Pulse Generator (Option SM-B4)**

Test equipment	<ul style="list-style-type: none"> <li>-Oscilloscope (Section 5.1, item 7)</li> <li>- Pulse generator (Section 5.1, item 17)</li> </ul>
Test setup	<p>Connect the pulse generator to the PULSE socket.</p> <p>Connect sockets SYNC and VIDEO to the two channels of the oscilloscope.</p> <p>Switch on an input resistance of 50 Ohm at the oscilloscope or use feed-through termination.</p>
Measurement Single pulses	<ul style="list-style-type: none"> <li>➤ Settings at the SME</li> <li style="padding-left: 20px;">In Menu MODULATION/PULSE</li> <li style="padding-left: 20px;">- SOURCE PULSE-GEN,</li> <li style="padding-left: 20px;">- PERIOD 100 ns,</li> <li style="padding-left: 20px;">- WIDTH 20 ns,</li> <li style="padding-left: 20px;">- PULSE DELAY 60 ns,</li> <li style="padding-left: 20px;">- DOUBLE PULSE STATE OFF,</li> <li style="padding-left: 20px;">- TRIGGER MODE AUTO,</li> <li style="padding-left: 20px;">- EXT TRIGGER SLOPE POS.</li> </ul>

- Settings at the Oscilloscope
    - Time base 20 ns/div,
      - both channels 2 V/div,
    - Triggering from the SYNC signal.
- SYNC output.....Pulse sequence with a pulse width of 40 ns  $\pm$ 10 ns  
 VIDEO output .....Pulse sequence with a pulse width of 20 ns  $\pm$ 4 ns,  
 the first edge appears after the first edge of the SYNC signal  
 by the pulse delay of 60 ns (-13ns,+ 23 ns).  
 SYNC and VIDEO output..... Period 100 ns,

**Note:** *The period is derived from the internal reference frequency and has its accuracy. There must be no error within the frame of the measuring accuracy of the oscilloscope.*

- Double pulses
- Settings at the SME
    - In menu MODULATION/PULSE
    - DOUBLE PULSE STATE ON,
    - WIDTH 20 ns,
    - DOUBLE PULSE DELAY 60 ns
- VIDEO output .....second pulse with a width of 20 ns  $\pm$ 4 ns,  
 .....Spacing to the first pulse 60 ns (+23ns, -13ns) .
- Ext. triggering
- Setting at the SME
    - In menu MODULATION/PULSE
    - TRIGGER MODE EXT
  - Settings at the pulse generator
    - TTL pulse sequence at 10 MHz

The pulse sequence at the oscilloscope must not change.
  - Trigger the oscilloscope on the PULSE input.
 

The pulse sequence may be offset by maximally 50 ns.
  - Repeat the measurements with pulse periods of up to 85s and pulse widths, pulse delays and double pulse spacings of up to 1s.

### 5.2.39 Multi-Function Generator (Option SM-B6)

#### 5.2.39.1 Frequency Error, Distortion Factor and Level

Test equipment	Audio analyzer (Section 5.1, item 14)
Test setup	Connect the audio analyzer to the LF output of the SME.
Measurement	<ul style="list-style-type: none"> <li>➤ SME settings                     <ul style="list-style-type: none"> <li>In menu LF OUTPUT</li> <li>- VOLTAGE 1 V</li> <li>- SOURCE LFGEN2</li> <li>- LFGEN2 SHAPE SIN</li> <li>- Vary LFGEN2 FREQ 20 Hz to 1 MHz.</li> </ul> </li> <li>➤ Read off the actual frequency at the audio analyzer. The values measured have to be precise within the scope of the counter resolution (error &lt;0.1 Hz).</li> <li>➤ Read off distortion factor at the audio analyzer. Rated value up to 100 kHz ..... &lt;0. 1%</li> <li>➤ Settings at the SME                     <ul style="list-style-type: none"> <li>Menu LF OUTPUT</li> <li>- SOURCE LFGEN2</li> <li>- LFGEN2 FREQ 1 kHz</li> <li>- LFGEN2 SHAPE SIN</li> <li>- Vary VOLTAGE from 3mV to 4 V (see below)</li> </ul> </li> <li>➤ Measure the output level using the audio analyzer. Deviation from rated value..... max. 1% + 1mV.</li> </ul>
Recommended settings	3 mV, 10 mV, 30 mV, 100 mV, 300 mV, 1 V, 2 V, 4 V

#### 5.2.39.2 Frequency Response

Test equipment	AC voltmeter (Section 5.1, item 19)
Test setup	Connect the AC voltmeter to the LF socket of the SME.
Measurement	<ul style="list-style-type: none"> <li>➤ Settings at the SME                     <ul style="list-style-type: none"> <li>In menu LF OUTPUT</li> <li>- SOURCE LFGEN2,</li> <li>- Vary LFGEN2 FREQUENCY from 10 Hz to 500 kHz.</li> </ul> </li> <li>Frequency response (difference between the smallest and largest level) .....up to 100 kHz &lt; 0.3 dB .....up to 500 kHz &lt;0.5 dB</li> </ul>

**Note:** The setting time is a mere computer time and thus need not be remeasured.

### 5.2.39.3 Distortion Factor and Crosstalk Attenuation Stereo

Test equipment	Modulation analyzer (Section 5.1, item 15)
Test setup	Connect modulation analyzer to the LF output of the SME
Measurement	<ul style="list-style-type: none"> <li>➤ Settings at the SME           <ul style="list-style-type: none"> <li>In menu MODULATION STEREO</li> <li>- MODE R,</li> <li>- AUDIO FREQ 1kHz,</li> <li>In menu LF OUTPUT</li> <li>- STEREO OUTPUT MPX.</li> </ul> </li> <li>➤ Read distortion factor at the modulation analyzer (signal R) Rated value.....&lt;0,1%</li> <li>➤ Measure the modulated signal of the right channel, note down value</li> <li>➤ Measure the demodulated signal of the left channel</li> <li>➤ Difference between modulated and demodulated signal .....&gt; 60 dB</li> <li>➤ Repeat measurement using setting MODE L</li> </ul>

### 5.2.39.4 Pilot Tone Level

Test equipment	AC voltmeter (Section 5.1, item 15)
Test setup	Connect AC voltmeter to the LF output of the SME.
Measurement	<ul style="list-style-type: none"> <li>➤ Settings at the SME           <ul style="list-style-type: none"> <li>In menu MODULATION STEREO</li> <li>- PILOT STATE ON</li> <li>In menu LF OUTPUT</li> <li>- STEREO OUTPUT PILOT</li> <li>- LF VOLTAGE 1V</li> </ul> </li> <li>➤ Read AC voltage of the pilot tone Rated value.....<math>0.707 V_{\text{eff}} \pm 14\text{mV}_{\text{eff}}</math>.</li> </ul>

### 5.2.40 Memory Extension (Option SME-B12)

**Note:** To ensure a proper functioning of the memory extension (XMEM) the modification status of the DM coder has to be at least VAR.2/REV.4. Menu UTILITIES-DIAG-CONFIG offers access to indication of module modification status.

The read/write function via the IEC/IEEE bus and the interplay between the XMEM and the DM coder during GFSK modulation (high bit rate) are first checked followed by checks of the dibit synchronization for QPSK and external triggering.

#### 5.2.40.1 Read/Write Check via the IEC/IEEE Bus

Measurement

- Read in/read out
- Call up digital modulation GFSK via the IEC/IEEE bus on the SME and activate memory extension (in R&S BASIC):  

```
IEC OUT 28, ":DM:TYPE GFSK;STAT ON;SOUR DATA"
IEC OUT 28, ":SOUR:DM:DATA:SEL 'XMEM' "
```
  - Read in first sequence into memory extension:  

```
IEC OUT 28, ":DM:DATA:XMEM:START 88;LENG 3"
IEC OUT 28, ":SOUR:DM:DATA:DATA 1,0,1"
```
  - Read in the three remaining sequences analogously.
  - Read out sequences and compare with those sent:  

```
IEC OUT 28, ":DM:DATA:XMEM:START 88;LENG 3"
IEC OUT 28, ":SOUR:DM:DATA:DATA?"
IEC IN 28, "SEQUENCE$: PRINT SEQUENCE$"
```

The sequences read in have to correspond to the sequences read out.

Recommended bit pattern

No.	Sequence	Sequence length (LENGTH)	Start address (START ADDRESS)
1	101	3	88
2	01010101011010	14	74
3	011101100101011	15	59
4	110011010001010 1	16	43

Measurement

- Interplay between XMEM and DM coder
- After completion of this test XMEM is set so that the fourth sequence is cyclically repeated and GFSK-modulated, and appears at the RF output.
- Check the spectrum at the RF output according to the following table. The levels refer to the carrier level with the modulation switched off:

Offset frequency / 72 kHz	0	-2	-6	-8	2	4	6	8
Level/ dB ±3 dB	-12.3	-11.0	-16.4	-24.0	-18.4	-12.2	-25.2	-24.0

Measurement

- Battery back-up
- The unit has to be switched off for at least 10 seconds and then to be switched on again.  

The above-mentioned spectrum has to be measured.



### 5.2.40.2 Dibit Synchronization

For modulations QPSK and 4FSK a symbol is coded with two successive bits (dibit), i.e. the X bit and the Y bit. The X bit is at the beginning of the sequence at the START ADDRESS as per definition. To ensure this allocation the DM coder and XMEM have to be synchronized when the modulation is switched on.

- Measurement
- Read in bit pattern No. 3 in the XMEM via IEC/IEEE bus as described in the previous section.
  - Settings at the SME
    - Level 0 dBm
    - RF-frequency 900 MHz
 in menu DIGITAL MOD QPSK
    - SOURCE DATA
    - CLOCK MODE BIT
    - SELECT LIST XMEM
    - CONFIG XMEM START ADDRESS 59
    - CONFIG XMEM LENGTH 4.
  - Vary the bit rate in the menu DIGITAL MOD QPSK from 30 kbps to 48 kbps in 1-kbps steps.  
At 900 MHz  $\pm$ BITRATE/4 there should be a spectral line exceeding the level at 900 MHz by 4 dB  $\pm$ 2 dB.

### 5.2.40.3 External Triggering

Test setup Feed in a positive pulse at the input TRIGGER (rear connector) (pulse duration >100 ns). Tap signal at the DATA output.

- Measurement
- Settings at the SME
    - Level 0 dBm
    - RF-frequency 900 MHz
 in menu DIGITAL MOD GMSK
    - SOURCE DATA
    - CLOCK MODE BIT
    - SELECT LIST XMEM
    - CONFIG XMEM START ADDRESS 59
    - CONFIG XMEM LENGTH 4
    - CONFIG XMEM EXT TRIGGER ON.
- After triggering, the DATA output should change from HIGH to LOW for approx. 3.7us.

## 5.3 Performance Test

<b>ROHDE&amp;SCHWARZ</b>	<b>SIGNAL GENERATOR SME</b>	<b>1038.6002. ....</b>
Serial number:		
Person testing:		
Date:		
Signature:		

Table 5-3 Test report

Item	Characteristic	Measur. acc. to Section	Min.	Actual	Max.	Unit
1	Display and keyboard	5.2.1	checked	.....	-	-
2	Frequency setting	5.2.2	checked	.....	-	-
3	Setting time	5.2.3	-	.....	10	ms
4	Reference frequency	5.2.4	-	.....		
5	Harmonics Level $\leq 10$ dBm Level without overrange Subharmonics f > 1.5 GHz f > 3.0 GHz	5.2.5	- - - - -	..... ..... ..... ..... .....	-30 -26 -40 -34	dBc dBc dBc dBc
6	Spuriae RF > 3.0 GHz (SME06) RF > 1.5 GHz (SME03E/03/06) RF $\leq 1.5$ GHz	5.2.6	- - -	..... ..... .....	-68 -74 -80	dBc dBc dBc
7	SSB phase noise RF = 90 MHz RF = 125 MHz RF = 250 MHz RF = 500 MHz RF = 1000 MHz RF = 2000 MHz (SME03E/03/06) RF = 3000 MHz (SME03/06) RF = 6000 MHz (SME06)	5.2.7	- - - - - - - -	..... ..... ..... ..... ..... ..... ..... .....	-129 -140 -137 -132 -126 -120 -110 -116	dBc (1 Hz) dBc (1 Hz) dBc (1 Hz) dBc (1 Hz) dBc (1 Hz) dBc (1 Hz) dBc (1 Hz) dBc (1 Hz)
8	Broadband noise	5.2.8	-	.....	-140	dBc (1 Hz)
9	Residual FM with RF=1 GHz	5.2.9	-	.....	4	Hz
10	Residual AM	5.2.10	-	.....	0.02	%

Item	Characteristic	Measur. acc. to Section	Min.	Actual	Max.	Unit
11	Output level	5.2.11				
	Frequency response		-	.....	1	dB
	Deviation from the rated value					
	RF $\leq$ 3 GHz		-	.....	1	dB
	RF $>$ 3 GHz		-	.....	1	dB
12	Output reflection coefficient	5.2.12				
	Test level $\leq$ 0 dBm, $f \leq$ 3 GHz		-	.....	1.5	(VSWR)
	Test level $\leq$ 0 dBm, $f >$ 3 GHz		-	.....	2.0	(VSWR)
	Test level $>$ 0 dBm		-	.....	2.0	(VSWR)
	Test level $>$ 0 dBm, $f >$ 5 GHz, with SM-B9		-	.....	2.5	(VSWR)
13	Interrupt-free level setting	5.2.13				
	-5 dB					
	-10 dB		-5.2	.....	-4.8	dB
	-15 dB		-10.4	.....	-9.6	dB
	-20 dB		-15.6	.....	-14.4	dB
			-20.8	.....	-19.2	dB
14	Overvoltage protection (SME02/03 only)	5.2.14				
	D.c. voltage		4	.....	7	V
	RF supply		0.5	.....	1	W
15	Level monitoring EXT1	5.2.15				
	lower limit		0.97	.....	0.99	V
	upper limit		1.01	.....	1.03	V
16	AM modulation depth	5.2.16				
	80%		75.8	.....	84.2	%
	30 %		27.8	.....	32.2	%
17	AM frequency response	5.2.17				
	20 Hz to 50 kHz		-	.....	1	dB
18	AM distortion factor	5.2.18				
	with AM 30%		-	.....	1	%
	with AM 80%		-	.....	2	%
19	Residual PhiM with AM	5.2.19				
	RF $\leq$ 3 GHz		-	.....	0.1	rad
	RF $>$ 3 GHz		-	.....	1.0	rad
20	Level monitoring EXT2	5.2.20				
	lower limit		0.97	.....	0.99	V
	upper limit		1.01	.....	1.03	V

Item	Characteristic	Measuram. acc. to Section	Min.	Actual	Max.	Unit
21	FM deviation setting	5.2.21				
	with 300 Hz		271	.....	31	Hz
	with 1 kHz		0.95	.....	9	kHz
	with 3 kHz		2.89	.....	1.0	kHz
	with 10 kHz		9.68	.....	5	kHz
	with 30 kHz		29.08	.....	3.1	kHz
	with 100 kHz		96.98	.....	1	kHz
22	FM frequency response	5.2.22				
	EXT1 10 Hz to 100 kHz		-	.....	0.5	dB
	EXT2 10 Hz to 100 kHz		-	.....	0.5	dB
	EXT1 10 Hz to 2 MHz		-	.....	3	dB
23	FM distortion factor	5.2.23	-	.....	0.5	%
	EXT2 10 Hz to 2 MHz		-	.....	3	dB
24	FM preemphasis	5.2.24				
	50 μs		-	.....	5	%
	75 μs		-	.....	5	%
25	Residual AM with FM	5.2.25	-	.....	0.1	%
26	Frequency deviation with FM	5.2.26				
	Deviation 0 Hz		-	.....	50	Hz
27	FM stereo modulation	5.2.27				
	Distortion factor		-	.....	0.1	%
	External voltage suppression		76	.....	-	dB
	Noise voltage suppression		76	.....	-	dB
28	PhiM deviation string	5.2.28				
	with 30 mrad		19	.....	41	mrad
	with 0.1 rad		0.087	.....	0.113	rad
	with 0.3 rad		0.281	.....	0.319	rad
	with 1.0 rad		0.96	.....	1.040	rad
	with 3.0 rad		2.90	.....	3.10	rad
29	PhiM frequency response	5.2.29				
	EXT1		-	.....	3	dB
	EXT2		-	.....	3	dB

Item	Characteristic	Measuram. acc. to Section	Min.	Actual	Max.	Unit
30	PhiM distortion factor	5.2.30	-	.....	1	%
31	Int. modulation generator	5.2.31				
	Frequency 400 Hz		388	.....	412	Hz
	Frequency 1 kHz		970	.....	1030	Hz
	Frequency 3 kHz		2910	.....	3090	Hz
	Frequency 15 kHz		14.55	.....	15.45	kHz
	Level		990	.....	1010	mV
32	Pulse modulation	5.2.32				
	ON/OFF ratio		80	.....	-	dB
	Rising time		-	.....	10	ns
	Fall time		-	.....	10	ns
	Delay time		-	.....	70	ns
33	GFSK modulation	5.2.33				
	Spectrum		checked	.....	-	kHz
	Deviation external "LOW"		-298	.....	-278	kHz
	Deviation external "HIGH"		+278	.....	+298	kHz
	Level DATA		checked	.....	-	kHz
	Frequency DATA		575.4	.....	576.6	
	Level BURST		checked	.....	-	kHz
	Frequency BURST		575.4	.....	576.6	
	Level CLOCK		checked	.....	-	kHz
	Frequency CLOCK		1150.85	.....	1153.15	%
	Deviation error		-	.....	7	
	Square-wave signal					%
	Amplitude		-3	.....	+3	%
	Overshoot			.....	3	
34	QPSK modulation	5.2.34				
	Spectrum		checked	.....	-	
	Vector error		-	.....	2.5	%
35	GMSK modulation	5.2.35				
	Spectrum		checked	.....	-	
	Phase error RMS		-	.....	1	%
	Phase error peak		-	.....	3	%

Item	Characteristic	Measur. acc. to Section	Min.	Actual	Max.	Unit
36	FFSK modulation	5.2.36				
	"HIGH" sequence					
	Peak deviation		3880	.....	4120	Hz
	Modulation frequency		1164	.....	1236	Hz
	Distortion factor		-	.....	1	%
	"LOW" sequence					
	Peak deviation		3880	.....	4120	Hz
	Modulation frequency		1746	.....	1854	Hz
	Distortion factor	-	.....	1	%	
37	LF generator	5.2.37				
	Frequency error		-	.....	1E-04	-
	Distortion factor		-	.....	0,1	%
	Level 3 mV		2	.....	4	mV
	Level 10 mV		8.9	.....	11.1	mV
	Level 30 mV		28.7	.....	31.3	mV
	Level 100 mV		98.0	.....	102.0	mV
	Level 300 mV		296	.....	304	mV
	Level 1 V		0.989	.....	1.011	V
	Level 2 V		1.979	.....	2.021	V
	Level 4 V		3.959	.....	4.041	V
	Frequency resp. up to 100 kHz		-	.....	0.3	dB
	Frequency resp. up to 400 kHz		-	.....	0.5	dB
38	Pulse generator	5.2.38				
	Pulse period		checked	.....	-	
	Pulse width		-5% -3 ns	.....	+5% +3 ns	
	Pulse delay		-5% -3 ns	.....	+5% +3 ns	
	Double pulse spacing		-5% -10 ns	.....	+5% +20 ns	
	Trigger delay		-	.....	50 ns	

Item	Characteristic	Measur. acc. to Section	Min.	Actual	Max.	Unit
39	Multi-function generator	5.2.39				
	Frequency error		-	.....	1E04	-
	Distortion factor		-	.....	0.1	%
	Level			.....		
	3 mV		2	.....	4	mV
	10 mV		8.9	.....	11.1	mV
	30 mV		28.7	.....	31.3	mV
	100 mV		98.0	.....	102.0	mV
	300 mV		296	.....	304	mV
	1 V		0.989	.....	1.011	V
	2 V		1.979	.....	2.021	V
	4 V		3.959	.....	4.041	V
	Frequency resp. up to 100 kHz		-	.....	0.3	dB
	Frequency resp. up to 500 kHz		-	.....	0.5	dB
	Stereo			.....		
Crosstalk attenuation	60	.....	-	dB		
Distortion factor	-	.....	0.1	%		
Pilot-tone level	0.693	.....	0.721	V		
40	Memory extension (option SME-B12)	5.2.40				
	Read in/read out		checked	.....	-	-
	Dibit synchronization		checked	.....	-	-
	External triggering		checked	.....	-	-





# Annex A

## IEC/IEEE Bus Interface

The instrument is equipped with an IEC/IEEE-bus connection as a standard. The mating connector according to IEEE 488 is at the rear of the instrument. A controller for remote control can be connected via the interface. The connection is effected using a shielded cable.

### Characteristics of the Interface

- 8-bit parallel data transfer
- bidirectional data transfer
- three line handshake
- high data transfer rate of max. 350 kByte/s
- up to 15 devices can be connected
- maximal length of the connecting cables 15 m (single connection 2m)
- wired OR if several instruments are connected in parallel.

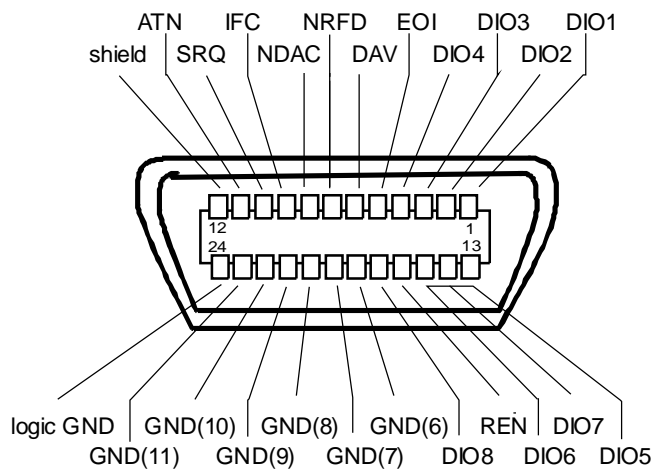

Fig. A-1 Contact Assignment of the IEC-bus socket

### Bus Lines

#### 1. Data bus with 8 lines DIO 1 to DIO 8.

The transmission is bit-parallel and byte-serial in the ASCII/ISO code. DIO1 is the bit of lowest order, DIO8 the bit of highest order.

**2. Control bus with 5 lines.**

**IFC** (Interface Clear),  
active low resets the interfaces of the instruments connected to the default setting.

**ATN** (Attention),  
active low signals the transmission of interface messages  
inactive high signals the transmission of device-dependent messages.

**SRQ** (Service Request),  
active low enables a device connected to send a service request to the controller.

**REN** (Remote Enable),  
active low permits the switchover to remote control.

**EOI** (End or Identify),  
has two functions in connection with ATN:  
active low marks the end of data transmission with ATN=high  
active low triggers a parallel poll with ATN=low.

**3. Handshake bus with three lines.**

**DAV** (Data Valid),  
active low signals a valid data byte on the data bus.

**NRF** (Not Ready For Data),  
active low signals that one of the device connected is not ready for data transfer.

**NDAC** (Not Data Accepted),  
active low as long as the instrument connected is accepting the data present on the data bus.

**Interface Functions**

Instruments which can be remote-controlled via IEC bus can be equipped with different interface functions. Table A-1 lists the interface functions appropriate for the instrument.

Table A- 1 Interface function

<b>Control character</b>	<b>Interface function</b>
SH1	Handshake source function (source handshake)
AH1	Handshake drain function (acceptor handshake)
L4	Listener function.
T6	Talker function, ability to respond to serial poll
SR1	Service request function (Service Request)
PP1	Parallel poll function
RL1	Remote/Local switchover function
DC1	Resetting function (Device Clear)
DT1	Trigger function (Device Trigger)

## Interface Messages

Interface messages are transmitted to the instrument on the data lines, with the attention line being active (LOW). They serve to communicate between instrument and controller.

### Universal Commands

The universal commands are encoded in the range 10 through 1F hex. They are effective for all instruments connected to the bus without addressing them before.

Table A- 2 Universal Commands

Command	QuickBASIC command	Effect on the instrument
DCL (Device Clear)	IBCMD (controller%, CHR\$(20))	Aborts the processing of the commands just received and sets the command processing software to a defined initial state. Does not change the instrument setting.
IFC (Interface Clear)	IBSIC (controller%)	Resets the interfaces to the default setting.
LLO (Local Lockout)	IBCMD (controller%, CHR\$(17))	The LOC/IEC ADDR key is disabled.
SPE (Serial Poll Enable)	IBCMD (controller%, CHR\$(24))	Ready for serial poll
SPD (Serial Poll Disable)	IBCMD (controller%, CHR\$(25))	End of serial poll
PPU (Parallel Poll Unconfigure)	IBCMD (controller%, CHR\$(21))	End of the parallel-poll polling state

### Addressed Commands

The addressed commands are encoded in the range 00 through 0F hex. They are only effective for instruments addressed as listeners.

Table A- 3 Addressed Commands

Command	QuickBASIC command	Effect on the instrument
SDC (Selected Device Clear)	IBCLR (device%)	Aborts the processing of the commands just received and sets the command processing software to a defined initial state. Does not change the instrument setting.
GET (Group Execute Trigger)	IBTRG (device%)	Triggers a previously active device function (eg a sweep). The effect of the command is the same as with that of a pulse at the external trigger signal input.
GTL (Go to Local)	IBLOC (device%)	Transition to the "Local" state (manual control)
PPC (Parallel Poll Configure)	IBPPC (device%, data%)	Configure instrument for parallel poll. The QuickBASIC command additionally executes PPE / PPD.

## RS-232-C Interface

The instrument is fitted with an RS-232-C interface as standard. The 9-pin connector is at the rear panel. A controller can be connected via this interface for remote control.

### Interface characteristics

- Serial data transmission in asynchronous mode
- Bidirectional data transmission via two separate lines
- Transmission rate selectable from 1200 to 115200 baud
- Logic 0 signal from +3 V to +15 V
- Logic 1 signal from -15 V to -3 V
- An external instrument (controller) can be connected
- Software handshake (XON, XOFF)
- Hardware handshake

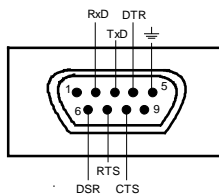

Fig. A-2 Pin assignment of RS-232-C connector

### Signal lines

**RxD** (Receive Data),

Data line, transmission from external controller to instrument.

**TxD** (Transmit Data),

Data line, transmission from instrument to external controller.

**DTR** (Data terminal ready),

Output (log. 0 = active). With DTR, the instrument indicates that it is ready to receive data. The DTR line controls whether the instrument is ready for reception or not.

**GND**,

Interface ground, connected to instrument ground.

**DSR** (Data set ready),

(Instead of the CTS line, the DSR connector is used for instruments with a VAR2 REV3 front module.)

**RTS** (Request to send),

Output (log 0 = active). With RTS, the instrument indicates that it is ready to receive data. The RTS line controls whether the instrument is ready for reception or not.

**CTS** (Clear to send),

Input (log 0 = active). CTS tells the instrument that the opposite station is ready to receive data.

## Transmission parameters

To ensure an error-free and correct data transmission, the parameters of the instrument and the controller should have the same settings. The parameters are set in menu UTILITIES-SYSTEM-RS232.

**Transmission rate (baud rate)** The following baud rates can be set in the instrument: 1200, 2400, 4800, 9600, 19200, 38400, 57600, 115200.

**Data bits** Data transmission is in 8-bit ASCII code. The first bit transmitted is the LSB (Least Significant Bit).

**Start bit** Each data byte begins with a start bit. The falling edge of the start bit indicates the beginning of the data byte.

**Parity bit** A parity bit is not used.

**Stop bit** The transmission of a data byte is terminated by a stop bit.

### Example:

Transmission of character A (41 hex) in the 8-bit ASCII code.

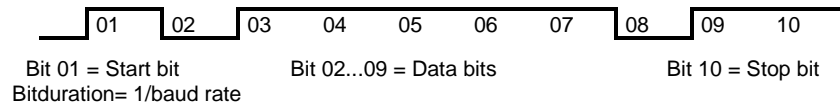

## Interface functions

For interface control, some control characters defined from 0 to 20 hex of the ASCII code can be transmitted via the interface (see Table A-4).

Table A- 4 Interface functions (RS-232-C)

Control character	Interface function
<Ctrl Q> 11 hex	Enables character output (XON)
<Ctrl S> 13 hex	Inhibits character output (XOFF)
Break (at least 1 character only log 0)	Reset instrument
0Dhex, 0Ahex	Terminator <CR>, <LF> Switchover between local/remote

## Handshake

### Software handshake

The software handshake with the XON/XOFF protocol controls data transmission. If the receiver wishes to inhibit data entry, it sends XOFF to the transmitter. The transmitter then interrupts the data output until it receives a XON. The same function is provided at the transmitter side (controller).

**Note:** Software handshake is not suitable for transmission of binary data. Use the hardware handshake.

### Hardware handshake

In case of a hardware handshake the instrument signals that it is ready for reception via line DTR and RTS. A logic 0 means "ready" and a 1 means "not ready". Whether the controller is ready for reception or not is signalled to the instrument via lines CTS or DSR (see signal lines). The transmitter of the instrument is switched on by a 0 and off by a 1. Line RTS remains active as long as the serial interface is active. Line DTR controls whether the instrument is ready for reception or not.

### Connection between instrument and controller

Connection of the instrument with the controller is via a so-called 0-modem cable. In this case, the data, control and signalling lines have to be cross-connected. For a controller with a 9-pin or 25-pin connector the following circuit diagram applies.

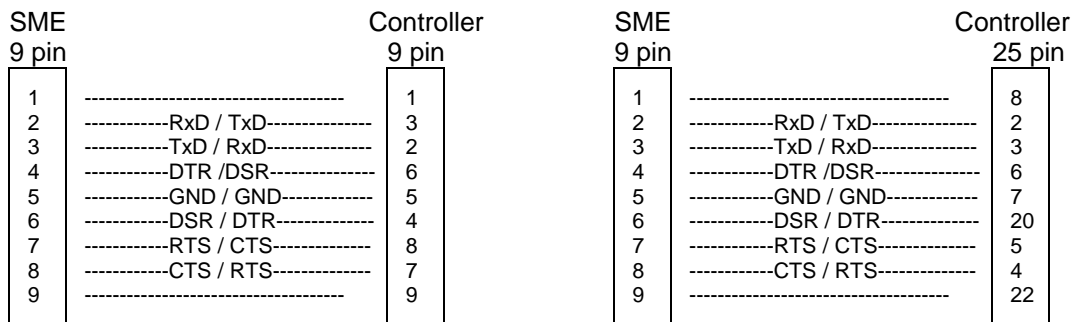

Fig. A-3 Wiring of data, control and signalling lines for hardware handshake

## Annex B

### List of Error Messages

The following list contains all error messages for errors occurring in the instrument. The meaning of negative error codes is defined in SCPI, positive error codes mark errors specific of the instrument.

The table contains the error code in the left-hand column. In the right-hand column the error text being entered into the error/event queue or being displayed is printed in bold face. Below the error text, there is an explanation as to the respective error.

### SCPI-Specific Error Messages

No Error

Error code	Error text in the case of queue poll Error explanation
0	<b>No error</b> This message is output if the error queue does not contain entries.

Command Error - Faulty command; sets bit 5 in the ESR register

Error code	Error text in the case of queue poll Error explanation
-100	<b>Command Error</b> The command is faulty or invalid.
-101	<b>Invalid Character</b> The command contains an invalid sign. Example: A header contains an ampersand, "SOURCE&".
-102	<b>Syntax error</b> The command is invalid. Example: The command contains block data the instrument does not accept.
-103	<b>Invalid separator</b> The command contains an impermissible sign instead of a separator. Example: A semicolon is missing after the command.
-104	<b>Data type error</b> The command contains an invalid value indication. Example: ON is indicated instead of a numeric value for frequency setting.
-105	<b>GET not allowed</b> A Group Execute Trigger (GET) is within a command line.
-108	<b>Parameter not allowed</b> The command contains too many parameters. Example: Command <code>SOURce:FM:INTernal:FREQuency</code> permits only one frequency indication.

Continuation: Command Error

Error code	Error text in the case of queue poll Error explanation
-109	<b>Missing parameter</b> The command contains too few parameters. Example: Command <code>SOURce:FM:INTernal:FREQuency</code> requires a frequency indication.
-112	<b>Program mnemonic too long</b> The header contains more than 12 signs.
-113	<b>Undefined header</b> The header is not defined for the instrument. Example: <code>*XYZ</code> is undefined for every instrument.
-114	<b>Header suffix out of range</b> The header contains an impermissible numeric suffix. Example: <code>SOURce3</code> does not exist in the instrument.
-123	<b>Exponent too large</b> The absolute value of the exponent is larger than 32000.
-124	<b>Too many digits</b> The number contains too many digits.
-128	<b>Numeric data not allowed</b> The command contains a number which is not allowed at this position. Example: Command <code>SOURce:FREQuency:MODE</code> requires the indication of a text parameter.
-131	<b>Invalid suffix</b> The suffix is invalid for this instrument. Example: <code>nHz</code> is not defined.
-134	<b>Suffix too long</b> The suffix contains more than 12 signs.
-138	<b>Suffix not allowed</b> A suffix is not allowed for this command or at this position of the command. Example: Command <code>*RCL</code> does not permit indicating a suffix.
-141	<b>Invalid character data</b> The text parameter either contains an invalid sign or it is invalid for this command Example: write error with parameter indication; <code>SOURce:FREQuency:MODE FIXed</code> .
-144	<b>Character data too long</b> The text parameter contains more than 12 signs.
-148	<b>Character data not allowed</b> The text parameter is not allowed for this command or at this position of the command. Example: Command <code>*RCL</code> requires a number to be indicated.
-158	<b>String data not allowed</b> The command contains a valid character string at a position which is not allowed. Example: A text parameter is set in quotation marks, <code>SOURce:FREQuency:MODE "FIXed"</code>
-161	<b>Invalid block data</b> The command contains faulty block data. Example: An END message was received before the expected number of data had been received.



Execution Error - Error in executing the command; sets bit 4 in the ESR register

Error code	Error text in the case of queue poll Error explanation
-168	<b>Block data not allowed</b> The command contains valid block data at an impermissible position.
-178	<b>Expression data not allowed</b> The command contains a mathematical expression at an impermissible position.
-203	<b>Command protected</b> The desired command could not be executed as it was protected with a password. Use command <code>SYSTEM:PROTECT OFF, &lt;password&gt;</code> to enable the command. Example: The command <code>CALibrate:PULSe:MEASure?</code> is protected with a password.
-211	<b>Trigger ignored</b> The trigger (GET, *TRG or trigger signal) was ignored due to device timing considerations.
-221	<b>Settings conflict</b> There is a settings conflict between two parameters. Example: FM1 and PM1 cannot be switched on at the same time.
-222	<b>Data out of range</b> The parameter value is out of the range permitted by the instrument. Example: Command *RCL only permits entries in the range of 0 to 50
-223	<b>Too much data</b> The command contains too many data. Example: The instrument does not have sufficient storage space.
-224	<b>Illegal parameter value</b> The parameter value is invalid. Example: An invalid text parameter is indicated, <code>TRIGger:SWEep:SOURce TASTe</code>
-225	<b>Out of memory</b> The storage space available in the instrument is exhausted. Example: An attempt is made to create more than 10 Memory Sequence lists.
-226	<b>Lists not of same length</b> The parts of a list have different lengths. This error message is also displayed if only part of a list has been transmitted via IEC bus. All parts of the list have to be transmitted always before it is executed. Example: The POWER list content is longer than the FREQUENCY list content, or only the POWER content is transmitted.
-230	<b>Data corrupt or stale</b> The data are incomplete or invalid. Example: The instrument has aborted a measurement.
-240	<b>Hardware error</b> The command cannot be executed due to problems with the instrument hardware.
-241	<b>Hardware missing</b> The command cannot be executed due to missing hardware. Example: An option is not fitted.
-255	<b>Directory full</b> The list management cannot accept any more lists as the maximum number of lists has already be attained. Example: Only 10 MEM SEQ lists can be created.

Device Specific Error - sets bit 3 in the ESR register.

Error code	Error text in the case of queue poll Error explanation
-310	<b>System error</b> This error message suggests an error within the instrument. Please inform the R&S Service.
-311	<b>Memory error</b> Error in the instrument memory.
-313	<b>Calibration memory lost</b> Loss of calibration data stored. The calibration data of VCO SUM, LEVEL PRESET and PULSE GEN can be restored by internal routines (see Chapter 2, Section Calibration).
-314	<b>Save/recall memory lost</b> Loss of the non-volatile data stored using *SAV? command.
-315	<b>Configuration memory lost</b> Loss of the non-volatile configuration data stored by the instrument.
-330	<b>Self-test failed</b> The selftest could not be executed.
-350	<b>Queue overflow</b> This error code is entered into the queue instead of the actual error code if the queue is full. It indicates that an error has occurred but not been accepted. The queue can accept 5 entries.
-360	<b>Communication error</b> An error has occurred during the transmission or reception of data on the IEC/IEEE bus or via the RS-232 interface.

Query Error - Error in data request; sets bit 2 in the ESR register.

Error code	Error text in the case of queue poll Error explanation
-410	<b>Query INTERRUPTED</b> The query has been interrupted. Example: After a query, the instrument receives new data before the response has been sent completely.
-420	<b>Query UNTERMINATED</b> The query is incomplete. Example: The instrument is addressed as a talker and receives incomplete data.
-430	<b>Query DEADLOCKED</b> The query cannot be processed. Example: The input and output buffers are full, the instrument cannot continue operation.

## SME-Specific Error Messages

Device-dependent Error - device-specific error; sets bit 3 in the ESR register.

Error code	Error text in the case of queue poll Error explanation
105	<b>Frequency underrange</b> The frequency is below the limit value guaranteed.
106	<b>Frequency overrange</b> The frequency is beyond the limit value guaranteed.
110	<b>Output unlevelled</b> The level control loop is deactivated.
115	<b>Level overrange</b> The level is above the limit value guaranteed.
116	<b>Level underrange</b> The level is below the limit value guaranteed.
117	<b>Dynamic level range exceeded</b> The difference between the maximal and minimal value of a level list is above 20 dBm. An exact level setting is no longer guaranteed.
120	<b>Signal output /ERMES setting mismatch - use RECALCULATE ►</b> ERMES settings have been changed during operating mode ERMES. However, the signal output is still based on the old settings. The output signal is recalculated from the current settings by selecting RECALCULATE ► in manual control or ERMES:STATe OFF; STATe ON via IEC bus.
121	<b>ERMES: Channel/Frequency mismatch</b> The RF has been readjusted and does no longer match the frequency indicated in the ERMES menu under CHANNEL. Setting ERMES CHANNEL does not only determine the RF but also influences the structure of the ERMES message. Thus the channel cannot simply be changed by readjusting the RF but only via ERMES CHANNEL and RECALCULATE ►.
125	<b>Signal output /FLEX setting mismatch - use RECALCULATE ►</b> FLEX settings have been changed during operating mode FLEX. However, the signal output is still based on the old settings. The output signal is recalculated from the current settings by selecting RECALCULATE ► in manual control or FLEX:STATe OFF; STATe ON via IEC bus.
130	<b>FM modulator VCO unlocked</b> FM modulator VCO is not synchronized.
131	<b>AM modulation frequency out of range</b> The AM modulation frequency is out of the permissible range.
132	<b>PM modulation frequency out of range</b> The PM modulation frequency is out of the permissible range.
140	<b>This modulation forces other modulations OFF</b> A modulation has been switched on which cannot be used at the same time as an already active modulation. The previous modulation has been switched off.
152	<b>Input voltage out of range; EXT1 too high</b> The input voltage at the EXT1 socket is too high.
153	<b>Input voltage out of range; EXT1 too low</b> The input voltage at the EXT1 socket is too low.

Continuation: Device-dependent Error

Error code	Error text in the case of queue poll Error explanation
154	<b>Input voltage out of range; EXT2 too high</b> The input voltage at the EXT2 socket is too high.
155	<b>Input voltage out of range; EXT2 too low</b> The input voltage at the EXT2 socket is too low.
161	<b>Output protection tripped</b> The overvoltage protection has responded (cf. Section 2.5.8).
162	<b>LF output overdriven</b> The dependency of the LF output voltage on other parameters in stereo operation has caused that the LF output would have to supply more than 4 volts. However, the voltage has been limited to 4 volts.
171	<b>Oven cold</b> The reference oscillator has not yet reached its operating temperature.
172	<b>Reference frequency 100 MHz VCXO unlocked</b> The 100-MHz quartz oscillator of the reference frequency has not been synchronized.
173	<b>Step synthesis unlocked</b> The step synthesis has not been synchronized.
180	<b>Calibration failed</b> Calibration could not be executed.
181	<b>REF OSC calibration data not used because ADJUSTMENT STATE is ON</b> The reference-oscillator calibration data are not used as long as ADJUSTMENT STATE is activated.
182	<b>Calibration data missing</b> Calibration data are missing in the device memory. The calibration data have to be generated first by an internal or external calibration or to be loaded into the device.
200	<b>Cannot access hardware</b> The data transmission to a module was unsuccessful.
201	<b>Function not supported by this hardware revision</b> A later version of certain parts of the instrument is necessary to execute the function selected.
202	<b>Diagnostic A/D converter failure</b> Diagnostic A/D converter has failed.
211	<b>Summing loop unlocked</b> The PLL of the summing loop has not been synchronized.
221	<b>Digital synthesis buffer VCO unlocked</b> The VCO of the buffer loop has not been synchronized.
231	<b>DATA coder clock unlocked</b> The clock oscillator of the data coder has not been synchronized.
232	<b>Cannot access data coder RAM</b> No data can be sent to the data coder. The data coder cannot be used as a source for a digital modulation.
240	<b>Invalid list; odd number of elements</b> The list selected contains an odd number of elements. Some lists, such as DM data for QPSK, however, must contain an even number of elements.

Continuation: Device-dependent Error

Error code	Error text in the case of queue poll Error explanation
241	<b>No list defined</b> There is no list defined..
242	<b>List not learned; execute LEARN command</b> The instrument has been switched to LIST mode and a list has been selected. However, command LEARN has not been executed.
243	<b>Dwell time adjusted</b> A dwell time given on a list cannot be processed by the unit. The setting was automatically adjusted.
251	<b>No User Correction Table; zero assumed</b> An attempt has been made to switch on user correction, but no UCOR table has been stored in the instrument yet. The instrument behaves as if a table was called which only contains 0-values.
260	<b>Invalid keyboard input ignored</b> An invalid input via the keyboard is not considered.
265	<b>This parameter is read only</b> An attempt has been made to change a fixedly specified value.
270	<b>Data output aborted</b> Data output was aborted on the IEC/IEEE-bus. Example: The key [LOCAL] was pressed.
304	<b>String too long</b> A character string which is too long was received via the IEC bus. The names of lists may have a length of maximally seven letters.
305	<b>Fill pattern too long; truncated</b> More data have been entered with block function FILL in the list editor than the filling range (RANGE) set permits. The exceeding data are ignored.
306	<b>No fill pattern specified</b> An attempt was made to execute a filler function without having to indicate a filler pattern.



# Annex C

## List of Commands (with SCPI Conformity Information)

The SME supports SCPI version 1994.0. For remote control, commands which were specified or accepted in this SCPI version have been used to a large extent. Commands which are not part of the SCPI specification are marked "not-SCPI" in the SCPI info.

Structure and Syntax of messages are explained in Chapter 3.5, and a detailed description of commands is to be found in Chapter 3.6.

Command	Parameter	SCPI info	Page
:ABORt:DM		not-SCPI	3.17
:ABORt:LIST		not-SCPI	3.17
:ABORt:MSEquence		not-SCPI	3.17
:ABORt[:SWEep]		not-SCPI	3.17
:ABORt:XMEM		not-SCPI	3.17
:CALibration:LEVel:DATA?		not-SCPI	3.19
:CALibration:LEVel:FRANge	NORMal   MIXer	not-SCPI	3.19
:CALibration:LEVel:PMODulator	ON   OFF	not-SCPI	3.19
:CALibration:LEVel:STATe	ON   OFF	not-SCPI	3.19
:CALibration:LPReset:DATA?		not-SCPI	3.19
:CALibration:LPReset[:MEASure]?		not-SCPI	3.19
:CALibration:PULSe:DATA?		not-SCPI	3.20
:CALibration:PULSe[:MEASure]?		not-SCPI	3.20
:CALibration:QPSK:STORe		not-SCPI	3.18
:CALibration:QPSK[:DATA]	0 to 10 000 ns   DEFault	not-SCPI	3.18
:CALibration:ROSCillator[:DATA]	0 to 4095	not-SCPI	3.20
:CALibration:VSUMmation:DAC?		not-SCPI	3.20
:CALibration:VSUMmation:KOS?		not-SCPI	3.20
:CALibration:VSUMmation[:MEASure]?		not-SCPI	3.20
:CALibration:VSUMmation:OFFS?		not-SCPI	3.20
:DIAGnostic:INFO:CCOunt:ATTenuator 1   2   3   4   5   6?			3.21
:DIAGnostic:INFO:CCOunt:POWer?			3.22

Command	Parameter	SCPI info	Page
:DIAGnostic:INFO:MODules?			3.22
:DIAGnostic:INFO:OTIME?			3.22
:DIAGnostic:INFO:SDATe?			3.22
:DIAGnostic[:MEASure]:POINt?			3.22
:DIAGnostic:XMEM:CHECKsum:ATTenuate?		not-SCPI	3.23
:DIAGnostic:XMEM:CHECKsum:BURSt?		not-SCPI	3.23
:DIAGnostic:XMEM:CHECKsum:CALCulate		not-SCPI	3.22
:DIAGnostic:XMEM:CHECKsum:DATA?		not-SCPI	3.23
:DIAGnostic:XMEM:CHECKsum[:TOTal]?		not-SCPI	3.23
:DISPlay:ANNotation[:ALL]	ON   OFF		3.24
:DISPlay:ANNotation:AMPLitude	ON   OFF		3.24
:DISPlay:ANNotation:FREQuency	ON   OFF		3.24
:FORMat:BORDER	NORMal   SWAPped		3.25
:FORMat:DATA	ASCIi   PACKed		3.25
:MEMory:NSTATes?			3.26
:OUTPut:AMODE	AUTO   FIXed	not-SCPI	3.26
:OUTPut:BLANK:POLarity	NORMal   INVerted	not-SCPI	3.27
:OUTPut:IMPedance?			3.27
:OUTPut:PROTEction:CLEar			3.27
:OUTPut:PROTEction:TRIPped?			3.27
:OUTPut[:STATe]	ON   OFF		3.27
:OUTPut[:STATe]:PON	OFF   UNCHanged	not-SCPI	3.27
:OUTPut2:SOURce	0   2	not-SCPI	3.28
:OUTPut2:SOURce:STEReo	MPX   PILot	not-SCPI	3.28
:OUTPut2[:STATe]	ON   OFF		3.28
:OUTPut2:VOLTage	0 V to 4 V	not-SCPI	3.28
[:SOURce]:AM[:DEPTH]	0 to 100 PCT		3.30
[:SOURce]:AM:EXTernal:COUpling	AC   DC		3.30



Command	Parameter	SCPI info	Page
[:SOURce]:AM:INTernal:FREQuency	400 Hz   1 kHz   3 kHz   15 kHz or 0.1 Hz to 500 kHz or 0.1 Hz to 1 MHz		3.31
[:SOURce]:AM:POLarity	NORMal   INVerted	not-SCPI	3.31
[:SOURce]:AM:SOURce	EXT   INT1 2   EXT, INT1 2		3.31
[:SOURce]:AM:STATe	ON   OFF		3.31
[:SOURce]:CORRection[:STATe]	ON   OFF		3.32
[:SOURce]:CORRection:CSET:CATalog?		not-SCPI	3.32
[:SOURce]:CORRection:CSET[:SElect]	'Name of table'	not-SCPI	3.32
[:SOURce]:CORRection:CSET:DATA:FREQuency	5 kHz to 1.5/2.2/3/6 GHz {,5 kHz to 1.5/2.2/3/6 GHz}	not-SCPI	3.33
[:SOURce]:CORRection:CSET:DATA:POWer	-40dB to 6dB {,-40dB to 6dB}	not-SCPI	3.33
[:SOURce]:CORRection:CSET:DELeTe	'Name of table'	not-SCPI	3.33
[:SOURce]:DM:MGRoup?		not-SCPI	3.35
[:SOURce]:DM[:BASic]:TYPE	GMSK   GFSK   QPSK   FSK   FSK4   FFSK	not-SCPI	3.36
[:SOURce]:DM[:BASic]:STATe	ON   OFF		3.36
[:SOURce]:DM[:BASic]:SOURce	EXTernal   PRBS   DATA		3.36
[:SOURce]:DM[:BASic]:CLOCK:MODE	BIT   SYMBol	not-SCPI	3.36
[:SOURce]:DM[:BASic]:CLOCK:POLarity	NORMal   INVerted	not-SCPI	3.36
[:SOURce]:DM[:BASic]:CLOCK:SOURce	INTernal   COUPled	not-SCPI	3.37
[:SOURce]:DM[:BASic]:DATA:CATalog?		not-SCPI	3.37
[:SOURce]:DM[:BASic]:DATA:DELeTe	'Name'	not-SCPI	3.37
[:SOURce]:DM[:BASic]:DATA:DELeTe:ALL		not-SCPI	3.37
[:SOURce]:DM[:BASic]:DATA:FREE?		not-SCPI	3.37
[:SOURce]:DM[:BASic]:DATA:SElect	'Name'	not-SCPI	3.37
[:SOURce]:DM[:BASic]:DATA:DATA	0   1 {, 0   1}	not-SCPI	3.38
[:SOURce]:DM[:BASic]:DATA:DATA:POINts?		not-SCPI	3.38
[:SOURce]:DM[:BASic]:DATA:ATTenuate	0   1 {, 0   1}	not-SCPI	3.38
[:SOURce]:DM[:BASic]:DATA:ATTenuate:POINts?		not-SCPI	3.38
[:SOURce]:DM[:BASic]:DATA:BURSt	0   1 {, 0   1}	not-SCPI	3.38

Command	Parameter	SCPI info	Page
[[:SOURce]:DM[:BASic]:DATA:BURSt:POINts?		not-SCPI	3.38
[[:SOURce]:DM[:BASic]:DATA:ALEVel	0 to 60 dB	not-SCPI	3.39
[[:SOURce]:DM[:BASic]:DATA:ALEVel:MODE	NORM   MAX	not-SCPI	3.39
[[:SOURce]:DM[:BASic]:DATA:XMEM:STARt	1 to 8388478 (XMEM:MODE = DATA)   1 to 1048558 (XMEM:MODE = ALL)	not-SCPI	3.39
[[:SOURce]:DM[:BASic]:DATA:XMEM:LENGth	3 to 8388480 (XMEM:MODE = DATA)   3 to 1048560 (XMEM:MODE = ALL)	not-SCPI	3.39
[[:SOURce]:DM[:BASic]:DATA:XMEM:LENGth:AUTO	ON   OFF	not-SCPI	3.39
[[:SOURce]:DM[:BASic]:DATA:XMEM:MODE	DATA   ALL	not-SCPI	3.39
[[:SOURce]:DM[:BASic]:DATA:XMEM:RECOrd		not-SCPI	3.40
[[:SOURce]:DM[:BASic]:DATA:XMEM:TRIGger	ON   OFF	not-SCPI	3.40
[[:SOURce]:DM[:BASic]:DATA:XMEM:TRIGger:SLOPe	POSitive   NEGative	not-SCPI	3.40
[[:SOURce]:DM[:BASic]:PRBS:LENGth	9   15   20   21   23	not-SCPI	3.40
[[:SOURce]:DM:COMPLex:CLOCK:SOURce	INT   EXT	not-SCPI	3.40
[[:SOURce]:DM:GMSK:STANdard	GSM   PCN   CDPD   MC9   MOBitex   MD24N   MD24W   MD36N   MD36W   MD48N   MD48W   MD80W   MD96N   MD96W   MD100W   MD120W   DSRR   DSRR4K	not-SCPI	3.41
[[:SOURce]:DM:GMSK:BRATe	2.4 kb/s to 1000 kb/s	not-SCPI	3.42
[[:SOURce]:DM:GMSK:DCODer	ON   OFF	not-SCPI	3.42
[[:SOURce]:DM:GMSK:FILTer	0.2   0.25   0.3   0.4   0.5	not-SCPI	3.42
[[:SOURce]:DM:GMSK:GSLope	ON   OFF	not-SCPI	3.43
[[:SOURce]:DM:GMSK:POLarity	NORMal   INVerted	not-SCPI	3.43
[[:SOURce]:DM:GFSK:STANdard	DECT   CT2   CT3	not-SCPI	3.43
[[:SOURce]:DM:GFSK:BRATe	10 to 585 kb/s and 640 to 1170 kb/s	not-SCPI	3.43
[[:SOURce]:DM:GFSK:DEViation	14   14.4   18   20.0   25.2   160   180   202   259   288   317   403 kHz	not-SCPI	3.44
[[:SOURce]:DM:GFSK:FILTer	0.4   0.5   0.6   0.7	not-SCPI	3.44
[[:SOURce]:DM:GFSK:POLarity	NORMal   INVerted	not-SCPI	3.44
[[:SOURce]:DM:QPSK:STANdard	NADC   PDC   TFTS   TETRa   APCO   MSAT   INMarsat	not-SCPI	3.44
[[:SOURce]:DM:QPSK:TYPE	PSK   0QPSk   PI4Qpsk   PI4Dqpsk	not-SCPI	3.45

Command	Parameter	SCPI info	Page
[:SOURce]:DM:QPSK:BRATe	1 to 24.3 kb/s and 27.0 to 48.6 kb/s	not-SCPI	3.45
[:SOURce]:DM:QPSK:CODing	NADC   PDC   TFTS   TETRa   APCO   MSAT   INMarsat	not-SCPI	3.45
[:SOURce]:DM:QPSK:FILTer	COSine SCOSine , 0.35 0.4 0.5 0.6   COSine, 0.2	not-SCPI	3.46
[:SOURce]:DM:QPSK:POLarity	NORMal   INVerted	not-SCPI	3.46
[:SOURce]:DM:FSK:STANdard	POCSag512  POCsag1200  POCsag2400  CITYruf512  CITYruf1200  CITYruf2400   FLEX1600   FLEX3200	not-SCPI	3.46
[:SOURce]:DM:FSK:BRATe	0.05 to 1900 kb/s (with FILTer OFF), 0.05 to 90 kb/s (with FILTer switched on)	not-SCPI	3.47
[:SOURce]:DM:FSK:DEViation	0 to 400 kHz	not-SCPI	3.47
[:SOURce]:DM:FSK:FILTer	GAUSS, 2.73   BESSel, 1.22   BESSel, 2.44   OFF	not-SCPI	3.47
[:SOURce]:DM:FSK:POLarity	NORMal   INVerted	not-SCPI	3.47
[:SOURce]:DM:FSK4:STANdard	ERMes   APCO   MODacom   FLEX3200   FLEX6400	not-SCPI	3.47
[:SOURce]:DM:FSK4:BRATe	1 to 24.3 kb/s   27.0 to 48.6 kb/s	not-SCPI	3.48
[:SOURce]:DM:FSK4:CODing	ERMes   APCO   MODacom   FLEX	not-SCPI	3.48
[:SOURce]:DM:FSK4:DEViation	0.01 to 400 kHz	not-SCPI	3.48
[:SOURce]:DM:FSK4:FILTer	BESSel, 1.22 1.25 2.44   COS SCOS, 0.2	not-SCPI	3.48
[:SOURce]:DM:FSK4:POLarity	NORMal   INVerted	not-SCPI	3.48
[:SOURce]:DM:FFSK:STANdard	POCSag	not-SCPI	3.48
[:SOURce]:DM:FFSK:BRATe	0.05 to 90 kb/s	not-SCPI	3.48
[:SOURce]:DM:FFSK[DEViation]	1.5 kHz   2.0 kHz   3.0 kHz   3.5 kHz   4.0 kHz   4.5 kHz	not-SCPI	3.48
[:SOURce]:ERMes:CHANnel	0 to 15	not-SCPI	3.50
[:SOURce]:ERMes:ERRor:BATCh	A to P {,A to P}	not-SCPI	3.50
[:SOURce]:ERMes:ERRor:MASk	0 to 1073741823	not-SCPI	3.50
[:SOURce]:ERMes:ERRor:WORD	0 to 153 (0 to 189 for long batch)	not-SCPI	3.50
[:SOURce]:ERMes:MESSAge:ALPHAnumeric:DATA	'String'	not-SCPI	3.51
[:SOURce]:ERMes:MESSAge:ALPHAnumeric[:SELect]	?FOX   ALPHA   USER1 to 4"		3.51

Command	Parameter	SCPI info	Page
[:SOURce]:ERMeS:MESSAge:CATegory	ALPHAnumeric   NUMeric   TONE	not-SCPI	3.51
[:SOURce]:ERMeS:MESSAge:IA   IADdress	0 to 262143	not-SCPI	3.51
[:SOURce]:ERMeS:MESSAge:NUMeric	'String'	not-SCPI	3.51
[:SOURce]:ERMeS:MESSAge:TONE	0 to 15	not-SCPI	3.52
[:SOURce]:ERMeS:NINFormation:OPERator	0 to 7	not-SCPI	3.52
[:SOURce]:ERMeS:NINFormation:PA   PAREa	0 to 63	not-SCPI	3.52
[:SOURce]:ERMeS:NINFormation:ZCOuntry	0 to 799	not-SCPI	3.52
[:SOURce]:ERMeS:SEQuence:DBATch	A to P	not-SCPI	3.52
[:SOURce]:ERMeS:SI SINFormation:BAI	ON   OFF	not-SCPI	3.52
[:SOURce]:ERMeS:SI SINFormation:DOMonth	1 to 31	not-SCPI	3.53
[:SOURce]:ERMeS:SI SINFormation:ETI	ON   OFF	not-SCPI	3.53
[:SOURce]:ERMeS:SI SINFormation:FSI	0 to 30	not-SCPI	3.53
[:SOURce]:ERMeS:SI SINFormation:TIME	00.00 to 23.59	not-SCPI	3.53
[:SOURce]:ERMeS:STATe	ON   OFF	not-SCPI	3.49
[:SOURce]:ERMeS:STATe:AUTO	ON   OFF	not-SCPI	3.50
[:SOURce]:ERMeS:TACTion	MESSAge   START   ONCE	not-SCPI	3.53
[:SOURce]:FLEX:CYCLE	0 to 14	not-SCPI	3.55
[:SOURce]:FLEX:DEVIation	2.0 to 10.0 kHz	not-SCPI	3.55
[:SOURce]:FLEX:ERRor:MASK	0 to 4294967295	not-SCPI	3.55
[:SOURce]:FLEX:ERRor:WORD	0 to 87	not-SCPI	3.55
[:SOURce]:FLEX:FCONtent	'X   blank spaces   O   A [,X] blank spaces   O   A ]'	not-SCPI	3.56
[:SOURce]:FLEX:FCONtent:AUTO	ON   OFF	not-SCPI	3.56
[:SOURce]:FLEX:MESSAge:ALPHAnumeric:CATalog?		not-SCPI	3.58
[:SOURce]:FLEX:MESSAge:ALPHAnumeric:DATA	'String'	not-SCPI	3.58
[:SOURce]:FLEX:MESSAge:ALPHAnumeric[:SElect]	'FOX'   'ALPHA'   'USER1'   'USER2'   'USER3'   'USER4'	not-SCPI	3.57
[:SOURce]:FLEX:MESSAge:BINary:BLENght	1 to 16	not-SCPI	3.58
[:SOURce]:FLEX:MESSAge:BINary:CATalog?		not-SCPI	3.58
[:SOURce]:FLEX:MESSAge:BINary:DATA	'0   1 [,0   1]'	not-SCPI	3.58

Command	Parameter	SCPI info	Page
[:SOURce]:FLEX:MESSAge:BINary:TYPE	LEFT   RIGHT   TRANSPARENT   THEader	not-SCPI	3.58
[:SOURce]:FLEX:MESSAge:BINary[:SElect]	'USER1	3.58	
[:SOURce]:FLEX:MESSAge:CAPCode	'Capcode string'	not-SCPI	3.57
[:SOURce]:FLEX:MESSAge:CATegory	ALPHANumeric   SECure   BINary   NUMeric   SNUMeric   TONE	not-SCPI	3.57
[:SOURce]:FLEX:MESSAge:MDRop	ON   OFF	not-SCPI	3.59
[:SOURce]:FLEX:MESSAge:MNUMbering	ON   OFF	not-SCPI	3.59
[:SOURce]:FLEX:MESSAge:NUMeric	'String'	not-SCPI	3.59
[:SOURce]:FLEX:MESSAge:REPeats	0 to 3	not-SCPI	3.59
[:SOURce]:FLEX:MESSAge:TONE	0 to 7	not-SCPI	3.59
[:SOURce]:FLEX:MODulation	1600, FSK2   3200, FSK2   3200, FSK4   6400, FSK4	not-SCPI	3.56
[:SOURce]:FLEX:PHASe	A   B   C   D   AB   AC   AD   BC   BD   CD   ABC   ABD   ACD   BCD   ABCD	not-SCPI	3.56
[:SOURce]:FLEX:PHASe:AUTO	ON   OFF	not-SCPI	3.57
[:SOURce]:FLEX:SI SINFormation:COLLapse	0 to 7	not-SCPI	3.59
[:SOURce]:FLEX:SI SINFormation:CZONE	0 to 31	not-SCPI	3.60
[:SOURce]:FLEX:SI SINFormation:DATE	Year, month, day	not-SCPI	3.60
[:SOURce]:FLEX:SI SINFormation:LCHannel	0 to 511	not-SCPI	3.60
[:SOURce]:FLEX:SI SINFormation:TIME	00,00 to 23,59	not-SCPI	3.60
[:SOURce]:FLEX:STATe	ON   OFF	not-SCPI	3.55
[:SOURce]:FLEX:STATe:AUTO	ON   OFF	not-SCPI	3.55
[:SOURce]:FLEX:TACTion	MESSAge   STARt   ONCE	not-SCPI	3.60
[:SOURce]:FM1 2[:DEViation]	0 to 1 MHz; SME03/03E: 0 to 2 MHz; SME06: 0 to 4 MHz		3.61
[:SOURce]:FM1 2:EXTernal1 2:COUPling	AC   DC		3.61
[:SOURce]:FM1 2:INTernal:FREQuency	400 Hz   1 kHz   3 kHz   15 kHz or 0.1 Hz to 500 kHz or 0.1 Hz to 1 MHz		3.62
[:SOURce]:FM1 2:PREEmphasis	0   50 us   75 us		3.62
[:SOURce]:FM1 2:SOURce	INTernal   EXTernal1   EXTernal2		3.62
[:SOURce]:FM1 2:STATe	ON   OFF		3.62

Command	Parameter	SCPI info	Page
[[:SOURce]:FREQuency:CENTer	5 kHz to 1.5 GHz (SME03E/03/06: 5 kHz to 2.2/3/6 GHz)		3.63
[[:SOURce]:FREQuency:MANual	5 kHz to 1.5 GHz (SME03E/03/06: 5 kHz to 2.2/3/6 GHz)		3.64
[[:SOURce]:FREQuency:MODE	CW   FIXed   SWEep   LIST		3.64
[[:SOURce]:FREQuency:OFFSet	-50 to +50 GHz		3.64
[[:SOURce]:FREQuency:SPAN	0 to 1.5 GHz (SME03E/03/06: 5 kHz to 2.2/3/6 GHz)		3.64
[[:SOURce]:FREQuency:STARt	5 kHz to 1.5 GHz (SME03E/03/06: 5 kHz to 2.2/3/6 GHz)		3.64
[[:SOURce]:FREQuency:STEP[:INCRement]	0 to 1 GHz		3.65
[[:SOURce]:FREQuency:STOP	5 kHz to 1.5 GHz (SME03E/03/06: 5 kHz to 2.2/3/6 GHz)		3.65
[[:SOURce]:FREQuency[:CW]:FIXed]	5 kHz to 1.5 GHz (SME03E/03/06: 5 kHz to 2.2/3/6 GHz)		3.63
[[:SOURce]:FREQuency[:CW]:FIXed]:RCL	INCLude   EXCLude		3.63
[[:SOURce]:ILS:STATe	ON   OFF	not-SCPI	3.67
[[:SOURce]:ILS:SOURce	INT2   INT2, EXT	not-SCPI	3.67
[[:SOURce]:ILS:TYPE	GS GSLope   LOCalize	not-SCPI	3.67
[[:SOURce]:ILS[:GS GSLope]:COMid:DEPTh	0 to 100 PCT	not-SCPI	3.68
[[:SOURce]:ILS[:GS GSLope]:COMid:FREQuency	0.1 to 20 000 Hz	not-SCPI	3.68
[[:SOURce]:ILS[:GS GSLope]:COMid:STATe]	ON   OFF	not-SCPI	3.68
[[:SOURce]:ILS[:GS GSLope]:DDM:CURRent	- 685 uA to + 685 uA	not-SCPI	3.68
[[:SOURce]:ILS[:GS GSLope]:DDM:DIRection	UP   DOWN	not-SCPI	3.68
[[:SOURce]:ILS[:GS GSLope]:DDM:LOGarithmic]	- 999.9 dB to + 999.9 dB	not-SCPI	3.68
[[:SOURce]:ILS[:GS GSLope]:DDM[:DEPTh]	- 0.8 to + 0.8	not-SCPI	3.68
[[:SOURce]:ILS[:GS GSLope]:LLOBe[:FREQuency]	100 to 200 Hz	not-SCPI	3.69
[[:SOURce]:ILS[:GS GSLope]:MODE	NORM   ULObE   LLOBe	not-SCPI	3.67
[[:SOURce]:ILS[:GS GSLope]:PHASe	0 to 120 deg	not-SCPI	3.69
[[:SOURce]:ILS[:GS GSLope]:PRESet		not-SCPI	3.69
[[:SOURce]:ILS[:GS GSLope]:SODEpth	0 to 100 PCT	not-SCPI	3.69
[[:SOURce]:ILS[:GS GSLope]:ULObE[:FREQuency]	60 to 120 Hz	not-SCPI	3.69

Command	Parameter	SCPI info	Page
[:SOURce]:ILS:LOCalizer:COMid:DEPTh	0 to 100 PCT	not-SCPI	3.70
[:SOURce]:ILS:LOCalizer:COMid:FREQuency	0.1 to 20 000 Hz	not-SCPI	3.70
[:SOURce]:ILS:LOCalizer:COMid[:STATe]	ON   OFF	not-SCPI	3.70
[:SOURce]:ILS:LOCalizer:DDM:CURRENT	-387 to +387 uA	not-SCPI	3.71
[:SOURce]:ILS:LOCalizer:DDM:DIRection	LEFT   RIGHT	not-SCPI	3.71
[:SOURce]:ILS:LOCalizer:DDM:LOGarithmic	-999.9 dB to +999.9 dB	not-SCPI	3.71
[:SOURce]:ILS:LOCalizer:DDM[:DEPTh]	-0.4 to +0.4	not-SCPI	3.71
[:SOURce]:ILS:LOCalizer:LLOBe[:FREQuency]	60 to 120 Hz	not-SCPI	3.71
[:SOURce]:ILS:LOCalizer:MODE	NORM   LLOBe   RLOBe	not-SCPI	3.70
[:SOURce]:ILS:LOCalizer:PHASe	0 to 120 deg	not-SCPI	3.72
[:SOURce]:ILS:LOCalizer:PRESet		not-SCPI	3.72
[:SOURce]:ILS:LOCalizer:RLOBe[:FREQuency]	100 to 200 Hz	not-SCPI	3.72
[:SOURce]:ILS:LOCalizer:SODepth	0 to 100 PCT	not-SCPI	3.72
[:SOURce]:LIST:CATalog?		not-SCPI	3.73
[:SOURce]:LIST:DELeTe	'Name of list'	not-SCPI	3.73
[:SOURce]:LIST:DELeTe:ALL		not-SCPI	3.73
[:SOURce]:LIST:DWELI	1 ms to 1 s {, 1 ms to 1 s}		3.74
[:SOURce]:LIST:DWELI:POINts?			3.74
[:SOURce]:LIST:FREE?			3.74
[:SOURce]:LIST:FREQuency	5 kHz to 1.5 GHz {, 5 kHz to 1.5 GHz}   block data (SME03/06: 5 kHz to 3/6 GHz)		3.74
[:SOURce]:LIST:FREQuency:POINts?			3.74
[:SOURce]:LIST:LEARn		not-SCPI	3.74
[:SOURce]:LIST:MODE	AUTO   STEP	not-SCPI	3.75
[:SOURce]:LIST:POWer	-144 to 16 dBm {, -144 to 16 dBm}   block data		3.75
[:SOURce]:LIST:POWer:POINts?			3.75
[:SOURce]:LIST:SELeCt	'Name of list'	not SCPI	3.75
[:SOURce][:FSWeep]:AMPLitude	ON   OFF		3.76
[:SOURce][:FSWeep]:AOFF			3.76

Command	Parameter	SCPI info	Page
[:SOURce]:[:FSWEEP]:FREQUency	5 kHz to 1.5 GHz (SME03E/03/06: 5 kHz to F/3/6 GHz)		3.76
[:SOURce]:MARKer1 2 3[:FSWEEP][:STATe]	ON   OFF		3.77
[:SOURce]:MARKer1 2 3:PSWEEP:AOff		not-SCPI	3.77
[:SOURce]:MARKer1 2 3:PSWEEP:POWer	-144 dBm to +16 dBm	not-SCPI	3.77
[:SOURce]:MARKer1 2 3:PSWEEP[:STATe]	ON   OFF	not-SCPI	3.77
[:SOURce]:MARKer1 2 3:POLarity	NORMal   INVerted	not-SCPI	3.77
[:SOURce]:MBEacon:COMid:DEPTH	0 to 100 PCT	not-SCPI	3.78
[:SOURce]:MBEacon:COMid:FREQUency	0.1 to 20 000 Hz	not-SCPI	3.78
[:SOURce]:MBEacon:COMid[:STATe]	ON   OFF	not-SCPI	3.78
[:SOURce]:MBEacon[:MARKer]:DEPTH	0 to 100 PCT	not-SCPI	3.78
[:SOURce]:MBEacon[:MARKer]:FREQUency	400 Hz   1300 Hz   3000 Hz	not-SCPI	3.78
[:SOURce]:MBEacon:STATe	ON   OFF	not-SCPI	3.78
[:SOURce]:PHASe[:ADJust]	-360 deg to +360 deg	not-SCPI	3.79
[:SOURce]:PHASe:REFerence		not-SCPI	3.79
[:SOURce]:PM1 2[:DEViation]	-360 to +360 deg		3.80
[:SOURce]:PM1 2:EXTernal1 2:COUPling	AC   DC		3.80
[:SOURce]:PM1 2:INTernal:FREQUency	400 kHz   1 kHz   3 kHz   15 kHz or 0.1 Hz to 500 kHz or 0.1 Hz to 1 MHz		3.81
[:SOURce]:PM1 2:SOURce	INTernal   EXTernal1   EXTernal2		3.81
[:SOURce]:PM1 2:STATe	ON   OFF		3.81
[:SOURce]:POCSag:BRATe	512bps   1200bps   2400bps	not-SCPI	3.83
[:SOURce]:POCSag:DEViation	1.5   2.0   3.0   3.5   4.0   4.5 kHz	not-SCPI	3.83
[:SOURce]:POCSag:ERRor:MASK	0 to 4294967295	not-SCPI	3.83
[:SOURce]:POCSag:ERRor:WORD	0 to 16	not-SCPI	3.83
[:SOURce]:POCSag:LBATches	0 to 100	not-SCPI	3.83
[:SOURce]:POCSag:MESSage		not-SCPI	3.83
[:SOURce]:POCSag:MESSage:ADDRes	0 to 209715	not-SCPI	3.83
[:SOURce]:POCSag:MESSage:ALPHanumeric:CATalog?		not-SCPI	3.84
[:SOURce]:POCSag:MESSage:ALPHanumeric:DATA	'String'	not-SCPI	3.84



Command	Parameter	SCPI info	Page
[[:SOURce]:POCSag:MESSage:ALPHanumeric[:SElect]			3.84
[[:SOURce]:POCSag:MESSage:CATegory	NUMeric   TONE   ALPHanumeric	not-SCPI	3.83
[[:SOURce]:POCSag:MESSage:NUMeric	'String'	not-SCPI	3.84
[[:SOURce]:POCSag:MESSage:SWORd	POCSag   INForuf	not-SCPI	3.84
[[:SOURce]:POCSag:MESSage:TONE	A   B   C   D	not-SCPI	3.84
[[:SOURce]:POCSag:MODulation	FSK   FFSK	not-SCPI	3.82
[[:SOURce]:POCSag:POLarity	NORMal   INVerted	not-SCPI	3.85
[[:SOURce]:POCSag:STATe	ON   OFF	not-SCPI	3.82
[[:SOURce]:POCSag:TACTion	MESSage   START   ONCE	not-SCPI	3.85
[[:SOURce]:POCSag:TSLice	2 to 120 sec	not-SCPI	3.85
[[:SOURce]:POWER:ALC:BANDwidth   BWIDth:AUTO	ON   OFF   ONCE	not-SCPI	3.86
[[:SOURce]:POWER:ALC:BANDwidth BWIDth	100 kHz   500 kHz	not-SCPI	3.86
[[:SOURce]:POWER:ALC[:STATe]	ON   OFF		3.87
[[:SOURce]:POWER[:LEVel][:IMMediate][:AMPLitude]	-144 to+16 dBm		3.87
[[:SOURce]:POWER[:LEVel][:IMMediate][:AMPLitude]:OFFSet	-100 to+100		3.87
[[:SOURce]:POWER[:LEVel][:IMMediate][:AMPLitude]:RCL	INCLude   EXCLude		3.87
[[:SOURce]:POWER:LIMit[:AMPLitude]	-144 to +16 dBm		3.88
[[:SOURce]:POWER:MANual	-144 to + 16 dBm		3.88
[[:SOURce]:POWER:MODE	FIXed   SWEep   LIST		3.88
[[:SOURce]:POWER:STARt	-144 to +16 dBm		3.88
[[:SOURce]:POWER:STEP[:INCRement]	0.1 to 10 dB		3.88
[[:SOURce]:POWER:STOP	-144 to +16 dBm		3.88
[[:SOURce]:PULM:EXTernal:IMPedance	50 Ohm   10 kOhm	not-SCPI	3.89
[[:SOURce]:PULM:INTernal:FREQuency	0.01176 Hz to10 MHz	not-SCPI	3.89
[[:SOURce]:PULM:POLarity	NORMal   INVerted	not-SCPI	3.89
[[:SOURce]:PULM:SOURce	EXTernal   INTernal	not-SCPI	3.89
[[:SOURce]:PULM:STATe	ON   OFF	not-SCPI	3.89
[[:SOURce]:PULSe:DELay	40 ns to 1 s	not-SCPI	3.90

Command	Parameter	SCPI info	Page
[:SOURce]:PULSe:DOUBle:DELay	60 ns to 1 s		3.90
[:SOURce]:PULSe:DOUBle[:STATe]	ON   OFF		3.90
[:SOURce]:PULSe:PERiod	100 ns to 85 s		3.90
[:SOURce]:PULSe:WIDTh	20 ns to 1s		3.90
[:SOURce]:REFLex25:AADaptation	ON   OFF	not-SCPI	3.96
[:SOURce]:REFLex25:DEViation	2.0 to 10.0 kHz	not-SCPI	3.92
[:SOURce]:REFLex25:ERRor:MASK	0 to 4294967295	not-SCPI	3.95
[:SOURce]:REFLex25:ERRor:WORD	0 to 351	not-SCPI	3.95
[:SOURce]:REFLex25:FCONtent	' A N T S R B F O 1 2 3 4 5 6 7 8 9 [, A N T S R B F O 1 2 3 4 5 6 7 8 9]	not-SCPI	3.96
[:SOURce]:REFLex25:MESSAge:ALPHAnumeric:CATalog?		not-SCPI	3.93
[:SOURce]:REFLex25:MESSAge:ALPHAnumeric:DATA			3.93
[:SOURce]:REFLex25:MESSAge:ALPHAnumeric[:SElect]			3.93
[:SOURce]:REFLex25:MESSAge:NUMeric			3.93
[:SOURce]:REFLex25:MESSAge:PADDress	16777216 to 1073741823	not-SCPI	3.92
[:SOURce]:REFLex25:MESSAge:RREQuired	ON   OFF	not-SCPI	3.93
[:SOURce]:REFLex25:MODulation	1600, FSL2   3200, FSK2   3200,FSK4   6400,FSK4	not-SCPI	3.92
[:SOURce]:REFLex25:SI SINformation:FCHannel:ANUMber	0 to 2047	not-SCPI	3.94
[:SOURce]:REFLex25:SI SINformation:FCHannel:ANUMber	0 to 2047	not-SCPI	3.94
[:SOURce]:REFLex25:SI SINformation:FCHannel:BASE	0 to 8191 MHz	not-SCPI	3.94
[:SOURce]:REFLex25:SI SINformation:FCHannel:SPEed	800   1600   6400   9600	not-SCPI	3.95
[:SOURce]:REFLex25:SI SINformation:FSPacing	0 to 102350	not-SCPI	3.95
[:SOURce]:REFLex25:SI SINformation:PROVider	0 to 16383	not-SCPI	3.94
[:SOURce]:REFLex25:SI SINformation:RCHannel:BASE	0 to 8191 MHz	not-SCPI	3.94
[:SOURce]:REFLex25:SI SINformation:SCIBase	0 to 127	not-SCPI	3.95
[:SOURce]:REFLex25:SI SINformation:SCICollapse	0 to 7	not-SCPI	3.95
[:SOURce]:REFLex25:SI SINformation:SZONE	0 to 127	not-SCPI	3.94
[:SOURce]:REFLex25:SI SINformation:ZONE	0 to 4091	not-SCPI	3.93
[:SOURce]:REFLex25:STATe	ON   OFF	not-SCPI	3.92

Command	Parameter	SCPI info	Page
[:SOURce]:REFLex25:STATe:AUTO	ON   OFF	not-SCPI	3.92
[:SOURce]:REFLex25:TACTion	MESSage   START   ONCE	not-SCPI	3.96
[:SOURce]:ROSCillator:EXTernal:FREQuency	1 to 16 MHz		3.97
[:SOURce]:ROSCillator[:INTernal]:ADJust[:STATe]	ON   OFF	not-SCPI	3.97
[:SOURce]:ROSCillator[:INTernal]:ADJust:VALue	0 to 4095	not-SCPI	3.97
[:SOURce]:ROSCillator:SOURce	INTernal   EXTernal	not-SCPI	3.97
[:SOURce]:STEReo:ARI:BK[:CODE]	A   B   C   D   E   F	not-SCPI	3.100
[:SOURce]:STEReo:ARI[:DEViation]	0 Hz to 10 kHz	not-SCPI	3.100
[:SOURce]:STEReo:ARI:TYPE	BK   DK   OFF	not-SCPI	3.100
[:SOURce]:STEReo:AUDio[:FREQuency]	0.1 Hz to 15 kHz	not-SCPI	3.99
[:SOURce]:STEReo:AUDio:MODE	RIGHT   LEFT   RELeft   REMLeft	not-SCPI	3.99
[:SOURce]:STEReo:AUDio:PREemphasis	OFF   50 us   75 u	not-SCPI	3.99
[:SOURce]:STEReo[:DEViation]	0 Hz to 100 kHz	not-SCPI	3.98
[:SOURce]:STEReo:PILot[:DEViation]	0 Hz to 10 kHz	not-SCPI	3.99
[:SOURce]:STEReo:PILot:PHASe	0 to 360 deg	not-SCPI	3.99
[:SOURce]:STEReo:PILot:STATe	ON   OFF	not-SCPI	3.99
[:SOURce]:STEReo:SIGNAL	AUDio   ARI	not-SCPI	3.98
[:SOURce]:STEReo:STATe	ON   OFF	not-SCPI	3.98
[:SOURce]:SWEep:BTIme	NORMal   LONG	not-SCPI	3.101
[:SOURce]:SWEep[:FREQuency]:DWELI	10 ms to 5 s	not-SCPI	3.101
[:SOURce]:SWEep[:FREQuency]:MODE	AUTO   MANual   STEP	not-SCPI	3.102
[:SOURce]:SWEep[:FREQuency]:POINts	Number	not-SCPI	3.102
[:SOURce]:SWEep[:FREQuency]:SPACing	LINear   LOGarithmic	not-SCPI	3.102
[:SOURce]:SWEep[:FREQuency]:STEP:LOGarithmic	0.01 to 50 PCT	not-SCPI	3.102
[:SOURce]:SWEep[:FREQuency]:STEP[:LINear	0 to 1 GHz	not-SCPI	3.102
[:SOURce]:SWEep:POWer:DWELI	1 ms to 5 s	not-SCPI	3.103
[:SOURce]:SWEep:POWer:MODE	AUTO   MANual   STEP	not-SCPI	3.103
[:SOURce]:SWEep:POWer:STEP:LOGarithmic	0 to 10 dB	not-SCPI	3.103

Command	Parameter	SCPI info	Page
[:SOURce]:VOR[:BANGLE]	0 to 360 deg	not-SCPI	3.105
[:SOURce]:VOR[:BANGLE]:DIRection	FROM   TO	not-SCPI	3.105
[:SOURce]:VOR:COMid:DEPTTh	0 to 100 PCT	not-SCPI	3.106
[:SOURce]:VOR:COMid:FREQuency	0.1 to 20 000 Hz	not-SCPI	3.106
[:SOURce]:VOR:COMid[:STATe]	ON   OFF	not-SCPI	3.106
[:SOURce]:VOR:MODE	NORM   VAR   SUBCarrier	not-SCPI	3.105
[:SOURce]:VOR:PRESet		not-SCPI	3.106
[:SOURce]:VOR:REFerence[:DEViation]	0 to 960 Hz	not-SCPI	3.106
[:SOURce]:VOR:SOURce	INT2   INT2, EXT	not-SCPI	3.104
[:SOURce]:VOR:STATe	ON   OFF	not-SCPI	3.104
[:SOURce]:VOR:SUBCarrier:DEPTTh	0 to 100 PCT	not-SCPI	3.105
[:SOURce]:VOR:SUBCarrier[:FREQuency]	5 to 15 kHz	not-SCPI	3.105
[:SOURce]:VOR:VAR:FREQuency	20 to 40 Hz	not-SCPI	3.105
[:SOURce]:VOR:VAR[:DEPTTh]	0 to 100 PCT	not-SCPI	3.105
:SOURce0 2:FREQuency[:CW   :FIXed]	400 Hz   1 kHz   3 kHz   15 kHz or 0.1 Hz to 500 kHz or 0.1 Hz to 1 MHz		3.108
:SOURce0 2:FREQuency:MANual	0.1 Hz to 500 kHz or 0.1 Hz to 1 MHz		3.108
:SOURce0 2:FREQuency:MODE	CW   FIXed   SWEep		3.108
:SOURce0 2:FREQuency:STARt	0.1 Hz to 500 kHz or 0.1 Hz to 1 MHz		3.108
:SOURce0 2:FREQuency:STOP	0.1 Hz to 500 kHz or 0.1 Hz to 1 MHz		3.108
:SOURce0 2:FUNCTion[:SHAPE]	SINusoid   SQUare   TRIangle   PRNoise   SAWTooth		3.109
:SOURce2:MARKer1 2 3[:FSWeep]:FREQuency	0.1 Hz to 500 kHz		3.110
:SOURce2:MARKer1 2 3[:FSWeep]:AOFF			3.110
:SOURce2:MARKer1 2 3[:FSWeep][:STATe]	ON   OFF		3.110
:SOURce2:MARKer1 2 3:POLarity	NORMal   INVerted	not-SCPI	3.110
:SOURce2:SWEep:BTIME	NORMal   LONG	not-SCPI	3.111
:SOURce2:SWEep[:FREQuency]:DWELI	1 ms to 1 s	not-SCPI	3.111
:SOURce2:SWEep[:FREQuency]:MODE	AUTO   MANual   STEP	not-SCPI	3.111

Command	Parameter	SCPI info	Page
:SOURce2:SWEep[:FREQuency]:POINts	Number	not-SCPI	3.112
:SOURce2:SWEep[:FREQuency]:SPACing	LINear   LOGarithmic	not-SCPI	3.112
:SOURce2:SWEep[:FREQuency]:STEP[:LINear]	0 to 500 kHz	not-SCPI	3.112
:SOURce2:SWEep[:FREQuency]:STEP:LOGarithmic	0.01 to 50PCT	not-SCPI	3.112
:STATus:OPERation:CONDition?			3.113
:STATus:OPERation:ENABLE	0 to 32767		3.114
:STATus:OPERation:NTRansition	0 to 32767		3.113
:STATus:OPERation:PTRansition	0 to 32767		3.113
:STATus:OPERation[:EVENT]?			3.113
:STATus:PRESet			3.114
:STATus:QUEStionable:CONDition?			3.114
:STATus:QUEStionable:ENABLE	0 to 32767		3.114
:STATus:QUEStionable:NTRansition	0 to 32767		3.114
:STATus:QUEStionable:PTRansition	0 to 32767		3.114
:STATus:QUEStionable[:EVENT]?			3.114
:STATus:QUEue [:NEXT]?			3.114
:SYSTem:BEEPer:STATe	ON   OFF		3.115
:SYSTem:COMMunicate:GPIB[:SELf]:ADDReSS	1 to 30		3.116
:SYSTem:COMMunicate:SERial:BAUD	1200  2400  4800  9600  19200  38400  57600  115200		3.116
:SYSTem:COMMunicate:SERial:CONTRol:RTS	ON   IBFull   RFR		3.116
:SYSTem:COMMunicate:SERial:PACE	XON   NONE		3.116
:SYSTem:ERRor?			3.116
:SYSTem:KLOCK	ON   OFF		3.117
:SYSTem:MODE	FIXed   MSEquence	not-SCPI	3.117
:SYSTem:MSEquence:CATalog?		not-SCPI	3.117
:SYSTem:MSEquence:DELeTe	'Name of sequence'	not-SCPI	3.117
:SYSTem:MSEquence:DELeTe:ALL		not-SCPI	3.117
:SYSTem:MSEquence:DWELI	50 ms to 60 s{,50 ms to 60 s}	not-SCPI	3.117

Command	Parameter	SCPI info	Page
:SYSTem:MSEquence:FREE?		not-SCPI	3.118
:SYSTem:MSEquence:MODE	AUTO   STEP	not-SCPI	3.118
:SYSTem:MSEquence:SElect	'Name of sequence'	not-SCPI	3.118
:SYSTem:MSEquence[:RCL]	1 to 50 {,1 to 50}	not-SCPI	3.118
:SYSTem:MSEquence[:RCL]:POINts?		not-SCPI	3.118
:SYSTem:PRESet			3.118
:SYSTem:PROtect1 2 3[:STATe]	ON   OFF, password	not-SCPI	3.119
:SYSTem:SECurity[:STATe]	ON   OFF		3.119
:SYSTem:SERRor?		not-SCPI	3.119
:SYSTem:VERSion?		not-SCPI	3.119
:TEST:BATTery:XMEM?			3.121
:TEST:BATTery[:RAM]?			3.121
:TEST:DIRect:ATTC	Subaddress, {,hex data string}	not-SCPI	3.120
:TEST:DIRect:DCOD	Subaddress {,hex data string}		3.121
:TEST:DIRect:DSYN0MUX	Subaddress {,hex data string}		3.121
:TEST:DIRect:DSYN1MUX	Subaddress {,hex data string}		3.121
:TEST:DIRect:FMOD	Subaddress {,hex data string}		3.121
:TEST:DIRect:LFGENA	Subaddress {,hex data string}		3.121
:TEST:DIRect:LFGENB	Subaddress {,hex data string}		3.121
:TEST:DIRect:MGEN	Subaddress {,hex data string}		3.121
:TEST:DIRect:OPU1M	Subaddress {,hex data string}		3.121
:TEST:DIRect:OPU3M	Subaddress {,hex data string}		3.121
:TEST:DIRect:OPU6M	Subaddress {,hex data string}		3.121
:TEST:DIRect:PUM	Subaddress {,hex data string}		3.121
:TEST:DIRect:REFSS	Subaddress {,hex data string}		3.121
:TEST:DIRect:ROSC	Subaddress {,hex data string}		3.121
:TEST:DIRect:SUM	Subaddress {,hex data string}	not-SCPI	3.120
:TEST:RAM?			3.121

Command	Parameter	SCPI info	Page
:TEST:ROM?			3.121
:TRIGger:DM:SOURce	AUTO   SINGLE   EXTERNAL	not-SCPI	3.123
:TRIGger:DM[:IMMediate]		not-SCPI	3.123
TRIGger:LIST[:IMMediate]		not-SCPI	3.124
:TRIGger:LIST:SOURce	AUTO   SINGLE   EXTERNAL	not-SCPI	3.125
:TRIGger:MSEquence:SOURce	AUTO   SINGLE   EXTERNAL	not-SCPI	3.125
:TRIGger:MSEquence[:IMMediate]		not-SCPI	3.125
:TRIGger:PULSe:SLOPe	POSitive   NEGative	not-SCPI	3.126
:TRIGger:PULSe:SOURce	EXTERNAL   AUTO	not-SCPI	3.126
:TRIGger:SLOPe		not-SCPI	3.126
:TRIGger1 2[:SWEep][:IMMediate]		not-SCPI	3.122
:TRIGger1 2[:SWEep]:SOURce	AUTO   SINGLE   EXTERNAL	not-SCPI	3.123
:UNIT:ANGLE	DEGREE   DEGREE   RADIAN		3.127
:UNIT:POWER	DBM   DBW   DBMW   DBUW   DBV   DBMV   DBUV   V		3.127





# Annex D

## Programming Examples

The examples explain the programming of the instrument and can serve as a basis to solve more complex programming tasks.

QuickBASIC has been used as programming language. However, the programs can be translated into other languages.

### 1. Including IEC-Bus Library for QuickBasic

```
REM ----- Include IEC-bus library for quickbasic -----
'$INCLUDE: 'c:\qbasic\qbdecl4.bas
```

### 2. Initialization and Default Status

The IEC bus as well as the settings of the instrument are brought into a defined default status at the beginning of every program. Subroutines "InitController" and "InitDevice" are used to this effect.

#### 2.1. Initiate Controller

```
REM ----- Initiate Instrument -----
REM InitController
iecaddress% = 28                                'IEC-bus address of the instrument
CALL IBFIND("DEV1", generator%)                 'Open port to the instrument
CALL IBPAD(generator%, iecaddress%)             'Inform controller on instrument address
CALL IBTMO(generator%, 11)                      'Response time to 1 sec
REM *****
```

#### 2.2. Initiate Instrument

The IEC-bus status registers and instrument settings of the SME are brought into the default status.

```
REM ----- Initiate Instrument -----
REM InitDevice
CALL IBWRT(generator%, "*CLS")                  'Reset status register
CALL IBWRT(generator%, "*RST")                 'Reset instrument
CALL IBWRT(generator%, "OUTPUT ON")           'Switch on RF output
REM*****
```

### 3. Transmission of Instrument Setting Commands

Output frequency, output level and AM modulation are set in this example. The settings correspond to the sample setting for first users in manual control. By analogy to the step width setting of the rotary knob, the step width is additionally set for the alteration of the RF frequency in the case of UP and DOWN.

```
REM ----- Instrument setting commands -----
CALL IBWRT(generator%, "FREQUENCY 250E6")           'RF Frequency 250 MHz
CALL IBWRT(generator%, "POWER -10")                 'Output power -10 dBm
CALL IBWRT(generator%, "AM 80")                     'AM with modulation index of 80%
CALL IBWRT(generator%, "AM:INTERNAL1:FREQUENCY 3KHZ") 'Modulation frequency 3kHz
CALL IBWRT(generator%, "AM:SOURCE INT1")            'Modulation source LF generator 1
CALL IBWRT(generator%, "FREQUENCY:STEP 12500")      'Step width RF frequency 12.5kHz
REM *****
```

### 4. Switchover to Manual Control

```
REM ----- Switch instrument over to manual control -----
CALL IBLOC(generator%)                               'Set instrument to Local state
REM *****
```

### 5. Reading out Instrument Settings

The settings made in example 3 are read out here. The abbreviated commands are used.

```
REM ----- Reading out instrument settings -----
Rffrequency$ = SPACE$(20)                           'Provide text variables with 20 characters
CALL IBWRT(generator%, "FREQ?")                     'Request frequency setting
CALL IBRD(generator%, Rffrequency$)                 'Read value

Rflevel$ = SPACE$(20)                               'Provide text variables with 20 characters
CALL IBWRT(generator%, "POW?")                       'Request level setting
CALL IBRD(generator%, Rflevel$)                     'Read value

AMmodulationdepth$ = SPACE$(20)                     'Provide text variables with 20 characters
CALL IBWRT(generator%, "AM?")                       'Request setting of modulation depth
CALL IBRD(generator%, AMmodulationdepth$)           'Read value

AMfrequency$ = SPACE$(20)                           'Provide text variables with 20 characters
CALL IBWRT(generator%, "AM:INT1:FREQ?")             'Request modulation frequency setting
CALL IBRD(generator%, AMfrequency$)                 'Read value

Stepwidth$ = SPACE$(20)                             'Provide text variables with 20 characters
CALL IBWRT(generator%, "FREQ:STEP?")               'Request step width setting
CALL IBRD(generator%, stepwidth$)                   'Read value

REM ----- Display values on the screen -----
PRINT "RF frequency:      "; Rffrequency$,
PRINT "RF level:         "; Rflevel$,
PRINT "AM modulationdepth: "; AMmodulationdepth$,
PRINT "AM frequency:     "; AMfrequency$,
PRINT "Step width:       "; stepwidth$
REM *****
```

## 6. List Management

```

REM ----- Example of list management -----
CALL IBWRT(generator%, "LIST:SELECT "+CHR$(34)+"LIST1"+CHR$(34))
'Select list "LIST1", is generated if necessary
CALL IBWRT(generator%, "LIST:POWER -30,-15,-10,-5,0,0.1)
'Fill power list with values
CALL IBWRT(generator%, "LIST:FREQ 575MHz,235MHz,123MHz,456MHz,735MHz,333MHz")
'Fill frequency list with values
CALL IBWRT(generator%, "LIST:DWELL 0.2")           '200ms per item
CALL IBWRT(generator%, "TRIGGER21:LIST:SOURCE AUTO") 'Permanently repeat list automatically
CALL IBWRT(generator%, "POWER:MODE LIST")         'Switch over instrument to list mode
REM *****

```

## 7. Command synchronization

The possibilities for synchronization implemented in the following example are described in Section 3.7.6, Command Order and Command Synchronization.

```

REM ----- Examples of command synchronization -----
REM Command ROSCILLATOR:SOURCE INT has a relatively long execution time
REM (over 300ms). It is to be ensured that the next command is only executed
REM when the reference oscillator has settled.

REM First possibility: Use of *WAI -----
CALL IBWRT(generator%, "ROSCILLATOR:SOURCE INT; *WAI; :FREQUENCY 100MHZ")

REM Second possibility: Use of *OPC? -----
OpcOk$ = SPACE$(2)           'Space for *OPC? - Provide response
CALL IBWRT(generator%, "ROSCILLATOR:SOURCE INT; *OPC?")
REM ----- here the controller can service other instruments -----
CALL IBRD(generator%, OpcOk$)           'Wait for "1" from *OPC?

REM Third possibility: Use of *OPC
REM In order to be able to use the service request function in conjugation with a National
REM Instruments GPIB driver, the setting "Disable Auto Serial Poll" must be changed to "yes"
REM by means of IBCONF.
CALL IBWRT(generator%, "**SRE 32")           'Permit service request for ESR
CALL IBWRT(generator%, "**ESE 1")           'Set event-enable bit for operation-complete bit
ON PEN GOSUB OpcReady                       'Initialization of the service request routine
PEN ON
CALL IBWRT(generator%, "ROSCILLATOR:SOURCE INT; *OPC")
REM Continue main program here
STOP                                         'End of program

OpcReady:
REM As soon as the reference oscillator has settled, this subroutine is activated
REM Program suitable reaction to the OPC service request.
ON PEN GOSUB OpcReady                       'Enable SRQ routine again
RETURN
REM *****

```

## 8. Service Request

The service request routine requires an extended initialization of the instrument in which the respective bits of the transition and enable registers are set.

In order to be able to use the service request function in conjunction with a National Instruments GPIB driver, the setting "Disable Auto Serial Poll" must be changed to "yes" by means of IBCONF.

```

REM ----- Example of initialization of the SRQ in the case of errors -----
CALL IBWRT(generator%, "**CLS")           'Reset status reporting system
CALL IBWRT(generator%, "**SRE 168")      'Permit service request for STAT:OPER-,
                                        'STAT:QUES- and ESR register
CALL IBWRT(generator%, "**ESE 60")      'Set event-enable bit for command, execution,
                                        'device-dependent and query error
CALL IBWRT(generator%, "STAT:OPER:ENAB 32767") 'Set OPERATION enable bit for all events
CALL IBWRT(generator%, "STAT:OPER:PTR 32767") 'Set appropriate OPERATION Ptransition bits
CALL IBWRT(generator%, "STAT:OPER:ENAB 32767") 'Set questionable enable bits for all events
CALL IBWRT(generator%, "STAT:OPER:PTR 32767") 'Set appropriate questionable Ptransition bits
ON PEN GOSUB Srq                        'Initialization of the service request routine
PEN ON
REM Continue main program here
STOP                                     'End of program

```

A service request is then processed in the service request routine.

**Note:** The variables *userN%* and *userM%* must be pre-assigned usefully.

```

Srq:
REM ----- Service request routine -----
DO
SRQFOUND% = 0
FOR I% = userN% TO userM%               'Poll all bus users
ON ERROR GOTO nouser                    'No user existing
CALL IBRSP(I%, STB%)                   'Serial poll, read status byte
IF STB% > 0 THE                          'This instrument has bits set in the STB
SRQFOUND% = 1
IF (STB% AND 16) > 0 THEN GOSUB Outputqueue
IF (STB% AND 4) > 0 THEN GOSUB Failure
IF (STB% AND 8) > 0 THEN GOSUB Questionablestatus
IF (STB% AND 128) > 0 THEN GOSUB Operationstatus
IF (STB% AND 32) > 0 THEN GOSUB Esrread
END IF
nouser:
NEXT I%
LOOP UNTIL SRQFOUND% = 0
ON ERROR GOTO error handling
ON PEN GOSUB Srq: RETURN                 'Enable SRQ routine again;
'End of SRQ routine

```

Reading out the status event registers, the output buffer and the error/event queue is effected in subroutines.

```

REM ----- Subroutines for the individual STB bits -----
Outputqueue:
Message$ = SPACE$(100)           'Reading the output buffer
CALL IBRD(generator%, Message$)  'Make space for response
PRINT "Message in output buffer :"; Message$
RETURN

Failure:
ERROR$ = SPACE$(100)             'Read error queue
CALL IBWRT(generator%, "SYSTEM:ERROR?")
CALL IBRD(generator%, ERROR$)    'Make space for error variable
PRINT "Error text :"; ERROR$
RETURN

Questionablestatus:
Ques$ = SPACE$(20)               'Read questionable status register
CALL IBWRT(generator%, "STATus:QUESTionable:EVENT?")
CALL IBRD(generator%, Ques$)     'Preallocate blanks to text variable
IF (VAL(Ques$) AND 128) > 0 THEN PRINT "Calibration ?"
IF (VAL(Ques$) AND 1) > 0 THEN PRINT "Voltage ?" 'Calibration is questionable
RETURN                            'Output level is questionable

Operationstatus:
Oper$ = SPACE$(20)               'Read operation status register
CALL IBWRT(generator%, "STATus:OPERation:EVENT?")
CALL IBRD(generator%, Oper$)     'Preallocate blanks to text variable
IF (VAL(Oper$) AND 1) > 0 THEN PRINT "Calibration"
IF (VAL(Oper$) AND 2) > 0 THEN PRINT "Settling"
IF (VAL(Oper$) AND 8) > 0 THEN PRINT "Sweeping"
IF (VAL(Oper$) AND 32) > 0 THEN PRINT "Wait for trigger"
RETURN

Esrread:
Esr$ = SPACE$(20)               'Read event status register
CALL IBWRT(generator%, "*ESR?")  'Preallocate blanks to text variable
CALL IBRD(generator%, Esr$)      'Read ESR
IF (VAL(Esr$) AND 1) > 0 THEN PRINT "Operation complete"
IF (VAL(Esr$) AND 4) > 0 THEN GOTO Failure
IF (VAL(Esr$) AND 8) > 0 THEN PRINT "Device dependent error"
IF (VAL(Esr$) AND 16) > 0 THEN GOTO Failure
IF (VAL(Esr$) AND 32) > 0 THEN GOTO Failure
IF (VAL(Esr$) AND 64) > 0 THEN PRINT "User request"
IF (VAL(Esr$) AND 128) > 0 THEN PRINT "Power on"
RETURN

REM *****

REM ----- Error routine -----
Error handling:
PRINT "ERROR"                    'Output error message
STOP                              'Stop software

```



## Index

- 4**
- 4FSK modulation ..... 2.97, 3.48
- A**
- Abort
- digital data recording ..... 2.83
  - triggered actions ..... 3.17
- Active edge
- external trigger
  - PULSE input ..... 2.62, 3.128
  - TRIGGER input ..... 2.83, 2.166, 3.40, 3.128
- Address
- IEC-bus ..... 3.3, 3.118
  - pager
  - ERMES ..... 2.104, 3.52
  - FLEX ..... 2.110, 3.58
  - POCSAG ..... 2.128, 3.85
  - REFLEX ..... 2.116, 3.93, 3.94
  - start (XMEM) ..... 2.83, 3.39
- Addressed commands ..... A6.3
- Airplane position ..... 2.66
- Alphanumeric message ..... 2.104
- Alternate switching off of modulations ..... 2.51
- AM**
- distortion factor ..... 5.21
  - frequency ..... 2.55, 3.31
  - frequency response ..... 5.20
  - modulation depth ..... 5.20
  - noise ..... 2.46
  - polarity ..... 2.55, 3.31
  - residual PhiM ..... 5.21
- Amplitude
- marker (RF sweep) ..... 2.139, 3.78
  - modulation (AM) ..... 2.54, 3.30
  - modulator (calibration) ..... 2.159
- Antenna lobe
- frequency
  - ILS-GS ..... 2.69, 3.71
  - ILS-LOC ..... 2.74, 3.73
  - phase
  - ILS-GS ..... 2.70, 3.71
  - ILS-LOC ..... 2.74, 3.74
- APCO25 (Association of Public Safety Communications)
- Officers, Project 25) ..... 2.78
  - Radio network ..... 2.86
- Area code (BK) ..... 2.64, 3.102
- ARI traffic channel ..... 2.63, 3.102
- ASCII character (#) ..... 3.11
- Asterix ..... 3.11
- Attenuator ..... 1.5, 2.44
- circuits (indication) ..... 2.164
- Audio signal ..... 2.63, 3.100
- Avionics systems ..... 2.64
- B**
- Bandwidth (level control) ..... 2.46, 3.88
- Batch
- ERMES ..... 2.105, 3.51
  - POCSAG ..... 2.130, 3.85
- Battery
- exchange ..... 4.1
  - self test ..... 3.123
- Baud rate (RS232) ..... 2.153, 3.118, 5
- Beeper ..... 2.167, 3.117
- Bit clock pulse ..... 2.92, 3.36
- Bit errors (ERMES) ..... 2.105, 3.51
- Bit rate
- 4FSK modulation ..... 2.98, 3.48
  - FFSK modulation ..... 2.101, 3.49
  - FLEX ..... 2.100, 3.57
  - FSK modulation ..... 2.95, 3.47
  - GFSK modulation ..... 2.90, 3.44
  - GMSK modulation ..... 2.88, 3.43
  - POCSAG ..... 2.128, 3.85
  - QPSK modulation ..... 2.93, 3.46
  - REFLEX ..... 2.116, 3.93
- Bit sequence (PRBS) ..... 3.40, 3.41
- BK (area code) ..... 2.64, 3.102
- BLANK
- output ..... 2.13, 2.136, 2.144, 2.166
  - time ..... 3.103
- Block data ..... 3.25
- Boolean parameter ..... 3.9
- Brief instructions ..... 3.1
- Brightness
- control (oscilloscope) ..... 2.137
  - display ..... 1.2, 2.9
- Broadband noise ..... 5.14
- Broadcasting code (DK) ..... 2.64, 3.102
- BURST
- input ..... 2.13, 2.86
  - memory ..... 2.79, 3.39
  - output ..... 2.13, 2.79, 3.36, 3.39
- BxT filter
- GFSK modulation ..... 2.90, 3.44
  - GMSK modulation ..... 2.88, 3.43
- C**
- Calibration
- disable ..... 2.158, 3.120
  - level ..... 2.158, 3.19
  - level preset ..... 2.159, 3.19
  - password ..... 2.158, 3.121
  - pulse generator ..... 2.160, 3.20
  - QPSK ..... 2.161, 3.18
  - VCO SUM ..... 2.158, 3.20
- Call (instrument settings) ..... 2.39, 3.14
- Capcode of the pager (FLEX) ..... 2.110, 3.58
- Carrier frequency deviation with FM ..... 5.25
- Caution messages ..... 2.170
- CDPD (Cellular Digital Packet Data) ..... 2.78
- Radio network ..... 2.86
- Center frequency (RF sweep) ..... 2.138, 3.65
- Character data ..... 3.8
- Checksum (XMEM) ..... 3.22, 4.6
- CITYRUF (German pager system) ..... 2.78
- Radio network ..... 2.86
- Cleaning the outside ..... 4.1
- Clock
- bit clock ..... 2.92, 3.36
  - edge ..... 2.92, 3.37
  - input/output ..... 2.11, 2.79, 2.86, 2.92, 3.36
  - source
  - ERMES ..... 2.131, 3.50
  - FLEX ..... 2.131, 3.55
  - POCSAG ..... 2.106, 3.84
  - REFLEX ..... 2.131, 3.93
  - symbol clock ..... 2.82, 3.36
- CMOS-RAM ..... 1.2
- Coding
- 4FSK modulation ..... 2.99, 3.49
  - GMSK modulation ..... 2.88, 3.43
  - QPSK modulation ..... 2.93, 3.46
- Colon separates ..... 3.11
- COM/ID signal (communication/identification signal) 2.66, 2.70
- ILS-GS ..... 2.70, 3.69

- ILS-LOC ..... 2.74, 3.72
- Marker Beacon ..... 2.76, 3.80
- VOR ..... 2.66, 3.108
- Command
  - addressed ..... 8C.3
  - parameter ..... 3.9
  - recognition ..... 3.131
  - seperates ..... 3.11
  - sequence ..... 3.132
  - structure ..... 3.6, 3.8
  - synchronization ..... 3.132
  - syntax elements ..... 3.11
  - universal ..... 8C.3
- Common commands ..... 3.5, 3.14
- Condition register ..... 3.134
- Contrast (display) ..... 1.2, 2.9
- Counter (indication) ..... 2.164
- Country code (ERMES) ..... 3.53
- Coupling
  - EXT1/2 ..... 3.30
  - AM ..... 2.54, 3.30
  - FM ..... 2.56, 3.63
  - PM ..... 2.59, 3.82
- Course Sector (ILS-LOC) ..... 2.74
- CTx (Cordless Telephony) ..... 2.78
  - Radio network ..... 2.86
- Current of the ILS indicating instrument. 2.69, 2.73, 3.70, 3.73
- D**
- Data
  - generator (DM) ..... 2.79, 3.37
  - input ..... 2.11, 2.86, 3.36
  - memory ..... 2.79, 3.38
  - output ..... 2.11, 2.79, 3.36
  - sequence length (XMEM) ..... 2.83, 3.39
  - source (DM) ..... 2.86, 3.36
- Data bits RS232 ..... 2.153, 5
- Data lines (IEC/IEEE-bus) ..... A6.1
- Data source DM ..... 2.78
- DCL ..... 3.130
- DDM (Difference in Depth of Modulation) ..... 2.69, 2.73
  - ILS-GS ..... 2.69, 3.70
  - ILS-LOC ..... 2.73, 3.73
- Decimal point ..... 2.3, 3.9
- DECT (Digital European Cordless Telephony) ..... 2.78
  - Radio network ..... 2.86
- Delay
  - calibration QPSK ..... 2.161
  - DM ..... 2.86
  - double pulse ..... 2.62, 3.92
  - pulse modulation ..... 2.62, 3.92
- Delete
  - all data stored ..... 2.154
  - list entry ..... 2.35
- Delimiter ..... 3.130
- Delta phase ..... 2.156, 3.81
- Detuning (external) ..... 2.155
- Deviation
  - 4FSK modulation ..... 2.98, 3.49
  - FFSK modulation ..... 2.101, 3.49
  - FLEX ..... 2.108, 3.56
  - FM ..... 2.56, 3.63
  - FSK modulation ..... 2.95, 3.47
  - GFSK MODULATION ..... 2.90, 3.44
  - pilot tone ..... 2.64, 3.101
  - PM ..... 2.58, 3.82
  - POCSAG ..... 2.128, 3.85
  - REF signal (VOR) ..... 2.66, 3.108
  - REFLEX ..... 2.116, 3.93
  - stereo MPX signal ..... 2.63, 3.100
- Deviation Limits
  - FM ..... 2.57
  - PM ..... 2.59
- Difference coding (GSM) ..... 2.88, 3.43
- Difference in depth of modulation (DM)
  - ILS-GS ..... 2.69, 3.70
  - ILS-LOG ..... 2.73, 3.73
- Digit cursor ..... 2.18
- Digital modulation (DM) ..... 2.78, 3.34
- Digital synthesis ..... 1.5
- Disabling
  - calibration ..... 2.158, 3.120
  - indication ..... 2.164, 3.110
  - keyboard ..... 3.119
- DK (Broadcasting code) ..... 2.64, 3.102
- DM
  - coder ..... 1.9, 2.78
  - data generator ..... 2.79
  - data source ..... 2.78, 3.36
  - delays ..... 2.86
  - list ..... 2.79, 3.37
  - memory extension (XMEM) ..... 2.81, 3.39
  - radio network data ..... 2.86
  - Trigger ..... 2.95, 2.101, 3.125
- Double pulse ..... 2.62, 3.92
- DSRR (Digital Short Range Radio)
  - Radio network ..... 2.86
- Duration blank signal ..... 2.166
- Dwell list
  - LIST ..... 2.151, 3.76
  - MSEQ ..... 2.146, 2.148, 3.119
- Dwell time
  - level sweep ..... 2.140, 3.105
  - LF sweep ..... 2.142, 3.103
  - RF sweep ..... 2.139, 3.104
- E**
- Edge
  - clock ..... 3.37
  - external trigger
    - PULSE input ..... 2.62, 3.128
    - TRIGGER input ..... 2.83, 2.166, 3.40, 3.128
- Edit list ..... 2.31
- EMF ..... 2.49
- Enable register ..... 3.134
- EOI (command line) ..... 3.8
- ERMES(European Radio Message System) ..... 2.78
  - Radio communication service ..... 2.102, 3.50
  - Radio network ..... 2.86
- Error messages ..... 2.170, 3.121, 7B.1
- Error queue ..... 3.116, 3.118, 3.141
- ESE (event status enable register) ..... 3.137
- ETI (External Traffic Indicator Bit) ..... 2.104, 3.54
- Event status enable register (ESE) ..... 3.137
- Exponent ..... 3.9
- EXT1/2
  - coupling ..... 2.54, 2.56, 2.59, 3.30, 3.63, 3.82
  - input ..... 2.11
- External
  - data recording ..... 3.40
  - detuning ..... 2.155
  - modulation ..... 2.50
  - reference ..... 2.155, 3.99
  - trigger
    - LIST ..... 2.144, 3.126
    - memory extension XMEM ..... 2.82, 3.40
    - MSEQ ..... 2.150, 3.127
    - PULSE input (active edge) ..... 2.62, 3.128
    - pulse modulation ..... 3.127
    - sweep ..... 3.124
    - TRIGGER input (active edge) ..... 2.83, 3.40, 3.128



## F

Fast Restore Mode .....	3.143
FFSK modulation .....	2.100, 3.49
testing .....	5.37
Filler data	
ERMES .....	2.105
FLEX .....	2.113
POGSAG .....	2.130, 2.131
Filter	
4FSK modulation .....	2.99, 3.49
FSK modulation .....	2.96, 3.48
GFSK modulation .....	2.90, 3.44
GMSK modulation .....	2.88, 3.43
QPSK modulation .....	2.93, 3.46
Fitting option .....	1.4
FLEX (Flexible High Speed Paging System) .....	2.78
radio communication service .....	2.107, 3.55
Radio network .....	2.86
FM	
carrier (VOR) .....	2.66, 3.107
carrier frequency deviation .....	5.25
coupling .....	2.56, 3.63
deviation .....	2.56, 3.63
deviation limits .....	2.57
deviation setting .....	5.22
distortion factor .....	5.24
frequency .....	2.56, 3.64
modulator .....	1.7, 2.56
preemphasis .....	2.57, 3.64, 5.24
residual AM .....	5.24
stereo modulation .....	5.25
Format data (IEC bus) .....	3.25
Frequency	
accuracy .....	1.2
AM .....	2.55, 3.31
antenna lobe	
ILS-GS .....	2.69, 3.71
ILS-VOR .....	3.73
audio signal .....	2.63, 3.101
COM/ID signal	
ILS-GS .....	2.68, 3.70
ILS-LOC .....	2.74, 3.72
MARKER-BEACON .....	2.76, 3.80
VOR .....	2.66, 3.108
FM .....	2.56, 3.64
FM carrier (VOR) .....	2.66, 3.107
indication .....	2.18, 3.54
indication suppressed .....	2.154
LF generator .....	2.133, 3.110
LF sweep .....	2.141, 3.110
list .....	2.143, 3.76
offset .....	2.41, 3.66
PM .....	2.58, 3.83
pulse modulation .....	2.60, 3.91
REF signal (VOR) .....	2.66, 3.107
RF output signal .....	2.41, 3.65
RF sweep .....	2.138, 3.66
setting (testing) .....	5.6
VAR signal (VOR) .....	2.66, 3.107
Frequency marker	
LF sweep .....	2.142, 3.112
RF sweep .....	2.139, 3.78
Frequency modulation (FM) .....	2.56, 3.63
Frequency of the COM/ID signal	
Marker Beacon .....	2.76
Frequency sweep	
LF .....	2.141, 3.113
RF .....	2.138, 3.103
Front unit .....	1.5
FSI (Frequency Subset Indicator) .....	2.104, 3.54
FSK modulation .....	2.94, 3.47

Functional test .....	4.5
<b>G</b>	
GET (Group Execute Trigger) .....	3.131
GFSK modulation .....	2.89, 3.43
testing .....	5.29
GMSK modulation .....	2.87, 3.41
testing .....	5.34
GSM (Global System for Mobile Communications)	
Personal Communication System .....	2.78
Radio network .....	2.86
<b>H</b>	
Handshake RS232 .....	2.153, 3.118, 6
Harmonics suppression .....	5.10
Header (commands) .....	3.6
Header field display .....	2.18
Heterodyne .....	2.57, 2.59
<b>I</b>	
IEC/IEEE-bus	
address .....	2.152, 3.3, 3.118
interface .....	2.17, A6.1
language .....	2.155
ILS (Instrument Landing System)	
glide slope modulation .....	2.68, 3.69
GS default .....	2.70, 3.71
LOC default .....	2.74, 3.74
localizer modulation .....	2.72, 3.72
transmitting frequencies .....	2.70
Incompatible modulations .....	2.51
Indentations .....	3.12
Indication	
attenuator circuits .....	2.157, 2.164
counter indication .....	2.164
error messages .....	2.170, 3.116
modules .....	2.162, 3.22
operating-hours counter .....	2.164, 3.22
serial number .....	2.157, 2.164
software version .....	2.164, 3.22
suppressed .....	2.154, 3.22
Initial Status .....	1.2
INMARSAT-M (International Maritime Satellite) .....	2.78
Radio network .....	2.86
Input .....	2.50
buffer .....	3.130
BURST .....	2.13, 2.86
CLOCK .....	2.11, 2.86, 2.92, 3.37, 3.41
correction .....	2.23
DATA .....	2.11, 2.86, 3.36
EXT1/2 .....	2.11
modulations .....	2.50
PULSE .....	2.15, 2.60, 3.128
REF .....	2.15
resistance .....	2.11
TRIGGER .....	2.13, 2.82, 2.136, 2.144, 2.150, 2.166, 3.128
TUNE .....	2.15, 2.155
Insert list entry .....	2.34
Installation MARKER (output) .....	2.168
Instrument states (reset) .....	3.120
Instrument current .....	2.69, 2.73
Instrument settings	
call .....	2.39, 3.14
reset .....	2.37, 3.19
store .....	2.39, 3.16
Interface	
functions (IEC bus) .....	A6.2
functions (RS232) .....	A6.5
messages (IEC bus) .....	A6.3
Intermodulation ratio .....	2.46

- Interrupt ..... 3.136  
 Interrupt-free level setting ..... 2.45, 5.18  
 IST flag ..... 3.15
- K**
- Key
- / ←
  - [ASSIGN] ..... 2.21
  - [ERROR] ..... 2.170
  - [FREQ] ..... 2.41
  - [G/n] ..... 2.5
  - [HELP] ..... 2.169
  - [k/m] ..... 2.5
  - [LEVEL] ..... 2.43
  - [LOCAL] ..... 3.3
  - [M/μ ] ..... 2.5
  - [MENU1/2] ..... 2.21
  - [MOD ON/OFF] ..... 2.52, 2.165
  - [PRESET] ..... 1.3
  - [RCL] ..... 2.39
  - [RETURN] ..... 2.19
  - [RF ON / OFF] ..... 2.22, 2.49
  - [SAVE] ..... 2.39
  - [SELECT] ..... 2.19
  - [STATUS] ..... 2.169
  - [X1/Enter] ..... 2.5
- Key words (commands) ..... 3.6  
 Keyboard disabling ..... 3.119
- L**
- LEARN (LIST mode) ..... 2.143, 3.76
- Length
- bit sequence (PRBS) ..... 2.78, 3.41
  - data sequence (XMEM) ..... 2.83, 3.39
  - Sweep ..... 3.103
- LEV-ATT memory ..... 2.79, 3.38
- Level
- calibration ..... 2.159, 3.19
  - control ..... 2.46, 3.88
  - correction (list UCOR) ..... 2.47, 3.32
  - indication ..... 2.18
  - EMF ..... 2.49
  - resolution ..... 2.44
  - suppressed ..... 2.154, 3.19
  - limit ..... 2.44, 3.90
  - list ..... 2.143, 3.77
  - marker ..... 2.136, 3.79
  - monitoring ..... 2.71, 5.19, 5.22
  - offset ..... 2.43, 3.89
  - presetting (calibration) ..... 2.159, 3.19
  - reduction (DM) ..... 2.79, 3.39
  - RF output ..... 2.43, 3.89
  - setting (interrupt-free) ..... 2.45, 5.18
  - sweep ..... 2.140, 3.79
  - unit ..... 2.22, 2.43, 3.129
- Start level ..... 2.140  
 Stop level ..... 2.140  
 Sweep ..... 2.140
- LF
- generator ..... 1.6, 2.53, 2.133, 3.28, 3.109
  - frequency ..... 2.133, 3.110
  - signal shape ..... 2.133
  - testing ..... 5.37
  - waveform ..... 2.56, 3.111
- output ..... 2.11, 2.13, 2.132, 3.28  
 sweep ..... 3.110
- List
- attenuate (DM) ..... 3.38
  - burst (DM) ..... 3.38
  - data (DM) ..... 2.79, 3.38
  - delete ..... 2.30
- dwell
- LIST ..... 3.76
  - MSEQ ..... 2.148, 3.119
- edit ..... 2.31
- entry
- delete ..... 2.35
  - insert ..... 2.34
- fill 2.32
- frequency ..... 2.143, 3.76
- function LEARN ..... 2.143, 3.76
- generate ..... 2.29
- inputs/outputs ..... 2.144
- instrument states (MSEQ) ..... 3.120
- level (LIST) ..... 2.143, 3.77
- level correction (UCOR) ..... 2.47, 3.32
- manual processing of the list ..... 2.144
- memory extension (XMEM) ..... 2.81, 3.39
- mode ..... 3.126
- open ..... 2.29
- operating modes ..... 2.143, 3.75, 3.77, 3.90
- select ..... 2.29
- store ..... 2.31
- Load external data ..... 2.83, 3.40
- Long form (commands) ..... 3.7
- Lower-case (commands) ..... 3.7
- M**
- Maintenance ..... 4.1
- Mantissa ..... 3.9
- Marker
- level sweep ..... 2.136, 3.78
  - LF sweep ..... 2.142, 3.112
  - RF sweep ..... 2.139, 3.78
- Marker Beacon modulation ..... 2.76, 3.80
- MARKER output ..... 2.13, 2.137, 2.144, 2.166, 3.79, 3.112
- Maximal deviation
- FM ..... 2.57
  - PM ..... 2.59
- Maximum value (commands) ..... 3.9
- MC9 (French Communication network) ..... 2.78
- Radio network ..... 2.86
- MDxxx (Standards nach ETS-Spezifikationen)
- Radio network ..... 2.86
- Memory capacity data generator (DM) ..... 2.79
- Memory delet ..... 2.154
- Memory extension (XMEM) ..... 1.11, 3.39
- checksum ..... 3.22, 4.6
  - memory depth ..... 2.81, 3.40
  - sequence length ..... 2.83, 3.39
  - start address ..... 2.82, 3.39
  - testing ..... 5.42
  - trigger ..... 2.82, 3.40
- Memory list (MSEQ) ..... 3.120
- Memory location ..... 2.35
- Memory sequence (MSEQ) ..... 2.148, 3.119
- Menu
- call ..... 2.21
  - cursor ..... 2.18
  - DIGITAL MOD - 4FSK ..... 2.97
  - DIGITAL MOD - ERMES ..... 2.102
  - DIGITAL MOD - FFSK ..... 2.100
  - DIGITAL MOD - FSK ..... 2.94
  - DIGITAL MOD - GFSK ..... 2.89
  - DIGITAL MOD - QPSK ..... 2.91
  - DIGITAL MOD - ReFLEX ..... 2.119
  - DIGITAL-MOD-POCSAG ..... 2.127
  - DIGITAL-MOD-QPSK-CLOCK ..... 2.92
  - ERROR ..... 2.170
  - fields ..... 2.18
  - FREQUENCY ..... 2.41

- HELP..... 2.169
- LEVEL - ALC..... 2.46
- LEVEL - EMF..... 2.49
- LEVEL - LEVEL..... 2.43
- LEVEL - UCOR..... 2.47
- LF OUTPUT..... 2.132
- LIST..... 2.145
- MEM SEQ..... 2.150
- MODULATION - PM..... 2.58
- MODULATION - PULSE..... 2.61
- MODULATION - STEREO..... 2.63
- MODULATION- AM..... 2.54
- MODULATION ILS - LOC..... 2.72
- MODULATION MKR-BCN..... 2.76
- MODULATION-FM..... 2.56
- MODULATION-ILS-GS..... 2.68
- MODULATION-VOR..... 2.65
- path..... 2.18
- quick selection..... 2.21
- Status..... 2.169
- store..... 2.21
- summary..... 2.40
- SWEEP - FREQ..... 2.138
- SWEEP - LEVEL..... 2.140
- SWEEP - LF GEN2..... 2.141
- TILITIES - DIAG - TPOINT..... 2.163
- TILITIES - YSTEM - PIB..... 2.152
- UTILITIES - AUX I/O..... 2.166
- UTILITIES - BEEPER..... 2.167
- UTILITIES - CALIB - LEV PRESET..... 2.159
- UTILITIES - CALIB - QPSK..... 2.161
- UTILITIES - CALIB - VCO SUM..... 2.158
- UTILITIES - DIAG - CONFIG..... 2.162
- UTILITIES - DIAG - PARAM..... 2.164
- UTILITIES - INSTALL..... 2.168
- UTILITIES - MOD KEY..... 2.165
- UTILITIES - PHASE..... 2.156
- UTILITIES - PROTECT..... 2.157
- UTILITIES - REF OSC..... 2.155
- UTILITIES - SYSTEM - RS232..... 2.153
- UTILITIES - SYSTEM LANGUAGE..... 2.155
- UTILITIES - SYSTEM-SECURITY..... 2.154
- UTILITIES - TEST..... 4.5
- Menu keys..... 2.5
- Message
- ERMES..... 2.104, 2.105, 3.51
- FLEX..... 2.111, 3.58
- POCSAG..... 2.128, 3.85
- REFLEX..... 2.120, 3.94
- remote control..... 3.4
- Minimum value (commands)..... 3.8
- MKR-BCN (Marker Beacon modulation)..... 2.76, 3.80
- MOBITEX (Mobile data system)..... 2.78
- Radio network..... 2.86
- MODACOM (Mobile Data Communication)..... 2.78
- Radio network..... 2.86
- Modulation
- 4FSK..... 2.97, 3.48
- AM..... 2.54, 3.30
- FFSK..... 2.100, 3.49
- FM..... 2.56, 3.63
- FSK..... 2.94, 3.47
- generators..... 2.50, 5.23, 5.25
- GFSK..... 2.89, 3.43
- GMSK..... 2.87, 3.41
- ILS-GS..... 2.68, 2.75, 3.68
- ILS-LOC..... 2.72, 3.72
- incompatible..... 2.51
- inputs..... 2.50
- Marker Beacon..... 2.76
- PM..... 2.58, 3.82
- pulse..... 2.60, 3.91
- QPSK..... 3.45
- REFLEX..... 2.120, 3.94
- sources..... 2.50
- stereo..... 2.63, 3.100
- VOR..... 2.65, 3.106
- Modulation depth
- 30-Hz VAR signal (VOR)..... 3.107
- AM..... 2.54, 3.30
- BK..... 2.64, 3.102
- COM/ID signal..... 3.70
- ILS-GS..... 2.70, 3.69
- ILS-LOC..... 2.74, 3.72
- Marker Beacon..... 2.76, 3.80
- VOR..... 2.66, 3.108
- difference (DDM)..... 3.73
- DK..... 2.64, 3.102
- FM carrier (VOR)..... 2.66, 3.107
- PM..... 2.56, 3.82
- Modulation generator (testing)..... 5.27
- Module indication..... 2.162, 3.22
- MSAT (Mobile Satellite)..... 2.78
- Radio network..... 2.86
- MSEQ operating modes..... 2.148, 3.17
- Multifunction generator..... 1.9, 2.53
- testing..... 5.40
- Multi-transmitter..... 2.46
- N**
- NADC (North American Digital Cellular)..... 2.78
- Radio network..... 2.86
- Name of sequence (MSEQ)..... 3.120
- NAN..... 3.9
- Network information (ERMES)..... 3.53
- New Line (command line)..... 3.8
- NINF..... 3.9
- NTRansition register..... 3.134
- Numeric
- input (field)..... 2.3
- suffix..... 3.7
- values..... 2.3, 3.9
- O**
- Offset
- frequency..... 2.42, 3.65
- level..... 2.43, 3.89
- ON/OFF - ratio..... 5.28
- Opening the casing..... 1.4
- Operating modes..... 2.135
- Operating-hours (indication)..... 2.164, 3.22
- Option
- fitting..... 1.4
- SM-B1 - Reference oscillator OCXO..... 1.5, 2.155
- SM-B2 - LF generator..... 1.6, 2.53, 2.58
- SM-B3 - Pulse modulator..... 1.7, 2.61
- SM-B4 - Pulse generator..... 1.7, 2.60
- SM-B5 - FM/PM-modulator..... 1.7, 2.56, 2.58
- SM-B6 - Multifunction generator..... 1.9, 2.53
- SM-B8 - Pulse modulator 3 GHz..... 1.7
- SM-B9 - Pulse modulator 6 GHz..... 1.7
- SME-B11 - DM coder..... 1.9, 2.78
- SME-B12 - memory extension..... 1.11, 2.81
- SME-B19 - Rear panel connections for RF and LF..... 1.11
- SME-B41 - FLEX..... 1.11, 2.107
- SME-B42 - POCSAG..... 1.11, 2.127
- SME-B43 - ReFLEX25..... 2.116
- Output
- BLANK..... 2.13, 2.136, 2.144, 2.166
- buffer..... 3.132
- BURST..... 2.13, 2.79, 3.36, 3.39
- CLOCK..... 2.11, 2.79, 2.92, 3.37, 3.41
- DATA..... 2.11, 2.79, 3.36

- level RF ..... 2.43
- LF ..... 2.11, 2.13, 2.132, 3.28
- MARKER ..... 2.13, 2.137, 2.144, 2.166, 3.79, 3.112
- REF ..... 2.15, 2.155
- reflection coefficient ..... 5.17
- RF ..... 2.11, 3.27, 3.65
- SYNC ..... 2.15
- VIDEO ..... 2.15, 2.60
- voltage ..... 2.132
- X-AXIS ..... 2.13, 2.136
- OVEN COLD ..... 1.2
- Overlapping execution ..... 3.131
- Overload protection ..... 2.49
- Overmodulation ..... 2.51, 2.57, 2.71, 2.75
- Overview
  - DM
    - modulations ..... 2.50
    - radio network data ..... 2.78
  - menus ..... 2.40
  - modulation sources ..... 2.50
  - status register ..... 3.115, 3.135
  - syntax elements ..... 3.11
- Overvoltage protection (testing) ..... 5.19
- P**
  - Paging
    - ERMES ..... 2.104, 3.50, 3.52, 3.53
    - FLEX ..... 2.108, 3.58
    - POCSAG ..... 2.128, 3.85
    - REFLEX ..... 2.116, 3.94, 3.95
  - Parallel poll enable register (PPE) ..... 3.137, 3.141
  - Parameter (commands) ..... 3.9
  - Parity (RS232) ..... 3.118, 5
  - Password ..... 2.157, 3.121
  - Path (commands) ..... 3.6
  - Pattern setting (list editor) ..... 2.35
  - PCN (Personal Communication System)
    - Radio network ..... 2.86
  - PDC (Pacific Digital Cellular)
    - Radio network ..... 2.86
  - Performance test ..... 5.44
  - Period ..... 2.62
  - Phase
    - antenna lobe
      - ILS-GS ..... 2.70, 3.71
      - ILS-LOC ..... 2.74, 3.74
    - pilot tone ..... 2.64
    - RF output ..... 2.156, 3.81
  - Phase angle (VOR) ..... 2.66
  - Phase modulation ..... 2.58, 3.82
  - PhiM
    - deviation setting ..... 5.26
    - distortion factor ..... 5.27
    - frequency response ..... 5.26
  - Physical quantities ..... 3.8
  - Pilot tone ..... 2.64, 2.133, 3.28, 3.101
  - PM
    - coupling ..... 2.59, 3.82
    - deviation ..... 2.58, 3.82
    - deviation limits ..... 2.59
    - frequency ..... 2.58, 3.83
    - generator ..... 2.58, 3.83
    - modulator ..... 1.7, 2.58, 3.82
  - POCSAG (Post Office Code Standardization Advisory Group)
    - Radio network ..... 2.86
    - radiocommunication ..... 2.127, 3.41
  - Polarity
    - 4FSK modulation ..... 2.99, 3.49
    - AM ..... 2.55, 3.31
    - BLANK signal ..... 3.27
    - FSK modulation ..... 2.96, 3.48
    - GFSK modulation ..... 2.90, 3.45
    - GMSK modulation ..... 2.88, 3.43
    - marker signal ..... 2.166
    - pulse modulation ..... 2.62, 3.91
    - QPSK modulation ..... 2.93, 3.46
    - signal ..... 2.166
  - Power supply ..... 1.1, 1.5
  - PPE (Parallel poll enable register) ..... 3.137
  - PRBS generator ..... 2.80, 3.40
  - Preemphasis
    - FM ..... 2.57, 3.64, 5.24
    - stereo modulation ..... 2.64, 3.101
  - Preset ..... 1.3, 3.120
  - Programming Examples ..... 9D.1
  - Protection level ..... 3.121
  - Protective circuit ..... 3.27
  - Ptransition register ..... 3.134
  - Pulling range ..... 2.155
  - Pulse
    - delay ..... 2.62, 3.92
    - generator ..... 1.7, 2.60, 3.92
    - calibration ..... 2.160, 3.20
    - testing ..... 5.38
    - input ..... 2.60
    - modulation ..... 2.60, 3.91
    - polarity ..... 2.62, 3.91
    - modulator ..... 1.7, 2.61
    - testing ..... 5.28
    - period ..... 2.62, 3.92
    - width ..... 2.62, 3.92
  - PULSE input ..... 2.15, 3.128
  - Putting into operation ..... 1.1
  - Q**
    - QPSK
      - calibration ..... 2.161, 3.18
      - Modulation ..... 2.91, 5.32
      - testing ..... 5.32
    - Query ..... 3.5
    - responses ..... 3.8
    - Question ..... 3.11
    - Quick selection
      - menu ..... 2.21
      - parameter ..... 2.21
    - Quotation marks ..... 3.11
  - R**
    - Rack 19" ..... 1.12
    - Radio network data (DM) ..... 2.86
    - Radiocommunication Service
      - ERMES ..... 2.102, 3.41
      - FLEX ..... 2.107, 3.41
      - POCSAG ..... 2.127, 3.41
      - ReFLEX25 ..... 2.116, 3.41
    - RCL list (MSEQ) ..... 3.120
    - Recording of external data ..... 2.83, 3.40
    - REF
      - input/output ..... 2.15, 2.66, 2.155, 3.65
      - signal (VOR) ..... 2.64, 3.106
    - Reference
      - 10-MHz ..... 2.15
      - 50-MHz ..... 1.12
      - external ..... 2.155, 3.99
      - input/output ..... 3.99
      - internal ..... 3.99
      - oscillator OCXO ..... 1.5, 2.155, 3.99
      - step synthesis ..... 1.5
    - ReFLEX25 radiocommunication service ..... 2.116
    - REMOTE ..... 3.2
    - Remote-control interface

- IEC-bus ..... 2.15, 2.17, 1
- RS-232 ..... A6.4
- Remove paneling ..... 1.4
- Reset status reporting system ..... 3.142
- Residual
  - AM ..... 5.15
  - AM with FM ..... 5.24
  - FM ..... 5.14
  - PhiM with AM ..... 5.21
- Responses to queries ..... 3.8
- RF
  - channel (ERMES) ..... 2.103, 3.51
  - frequency ..... 2.41, 2.68
  - output ..... 2.11, 3.27
  - output level ..... 2.43, 3.89
  - sweep ..... 2.138, 3.103
- RF OFF ..... 2.49
- Rotary knob ..... 2.7, 2.19
- RS232 interface ..... 2.15, 2.153, 4
- S**
- Sample setting ..... 2.23
- Sample-and-hold operation ..... 2.46
- SCPI
  - Information ..... 7B.1
  - Introduction ..... 3.5
- Scrollbar ..... 2.19
- Select
  - 1-out-of-n ..... 2.20
  - mark ..... 2.18
- Self test ..... 3.16, 3.122, 4.5
- Semicolon separates ..... 3.11
- Sensitivity per percent modulation depth ..... 2.71, 2.75
- Sequence length
  - PRBS ..... 2.78, 3.41
  - XMEM ..... 2.83, 3.39
- Serial number ..... 2.164, 3.15
- Serial poll ..... 3.140
- Service request (SRQ) ..... 3.16, 3.140
- Service request enable (SRE) ..... 3.16, 3.136
- Setting commands ..... 3.5
- Setting value ..... 2.20
- Settling bit ..... 3.138
- Short form (commands) ..... 3.7
- Sign ..... 3.9
- Signal shape (LF generator) ..... 2.133, 3.111
- Simultaneous modulation ..... 2.51
- Single-pulse delay ..... 2.62
- Slots ..... 1.5
- Software
  - indication ..... 2.164
  - option ..... 1.11, 2.164
  - version ..... 2.168, 3.22
- Source resistance ..... 2.49
- Span RF sweep ..... 2.138
- Special characters ..... 3.13
- Spectral purity ..... 2.57, 2.59
- Square brackets ..... 3.7
- SRE (service request enable register) ..... 3.136
- SRQ (service request) ..... 3.16, 3.140
- SSB phase noise ..... 5.14
- STANDBY mode ..... 1.1, 1.2, 2.9
- Start address (XMEM) ..... 2.83, 3.39
- Start bit (RS-232-C) ..... A6.5
- Start frequency
  - LF sweep ..... 2.142, 3.110
  - RF sweep ..... 2.138, 3.66
- Start level (level sweep) ..... 2.140, 3.90
- State ..... 3.2
- STATus
  - OPERation register ..... 3.115, 3.138
- QUESTionable register ..... 3.116, 3.139
- Status byte (STB) ..... 3.136
- Status line ..... 2.18
- STATUS page ..... 2.169
- Status register overview ..... 3.135
- Status reporting system ..... 3.133
- STB (status byte) ..... 3.136
- Step width
  - DDM value with rotary knob ..... 2.74
  - level sweep ..... 2.140, 3.90
  - LF sweep ..... 2.142, 3.114
  - RF sweep ..... 2.138, 3.67
  - rotary knob
    - carrier frequency ..... 2.67, 2.75
    - frequency variation ..... 2.41
    - level variation ..... 2.44
- Stereo modulation ..... 2.63, 3.100
- Stereo multiplex signal ..... 2.63, 2.133, 3.28, 3.100
- Stop bit (RS232) ..... 3.118, 5
- Stop frequency
  - LF sweep ..... 2.142, 3.110
  - RF sweep ..... 2.138, 3.67
- Stop level (level sweep) ..... 2.140, 3.90
- Storage ..... 4.1
- Store
  - instrument settings ..... 2.39
  - list ..... 2.31
- Structure
  - command ..... 3.6
  - command line ..... 3.8
- Subcarrier (VOR) ..... 2.66
- Subharmonics ..... 5.10
- Sum bit ..... 3.134
- Sum deviation ..... 2.51
- Sum modulation depth ..... 2.51
  - ILS-GS signal contents ..... 2.69
  - ILS-LOC signal contents ..... 2.73
  - two-tone modulation ..... 2.51
- Summing loop ..... 1.5, 2.158
- Sweep ..... 2.134
  - level ..... 2.140, 3.90
  - LF ..... 2.141, 3.112
  - outputs ..... 2.136
  - RF ..... 2.138, 3.103
  - run
    - level sweep ..... 2.140, 3.105
    - LF sweep ..... 2.142, 3.113
    - RF sweep ..... 2.138, 3.104
  - trigger ..... 3.124
- Switchover to remote control ..... 3.2
- Symbol ..... 2.21
- Symbol clock ..... 2.92, 3.36
- SYNC output ..... 2.15
- Synthesis range ..... 2.57, 2.59
- T**
- Temperature dependence of oscillator ..... 2.160
- TEST points ..... 2.163, 3.22
- TETRA (Trans European Trunked Radio) ..... 2.78
  - Radio network ..... 2.86
- TFTS (Terrestrial Flight Telephone System) ..... 2.78
  - Radio network ..... 2.86
- Traffic area code ..... 2.64
- Trigger
  - action ..... 2.21
  - active edge
    - PULSE input ..... 2.62, 3.128
    - TRIGGER input ..... 2.83, 2.166, 3.40, 3.128
  - DM ..... 2.95, 2.101

<i>input</i> .....	2.13, 2.62, 2.82, 2.83, 2.136, 2.144, 2.150, 2.166, 3.40, 3.128
<i>LIST</i> .....	2.144, 3.126
<i>memory extension (XMEM)</i> .....	2.82, 3.40
<i>MSEQ</i> .....	2.150, 3.127
<i>oscilloscope</i> .....	2.136
<i>pulse modulation</i> .....	2.62, 3.127
<i>sweep</i> .....	2.136, 3.124
<i>XY recorder</i> .....	2.136
<i>Truth values</i> .....	3.8
<i>TUNE input</i> .....	2.15, 2.155
<i>Tuning voltage</i> .....	2.156
<i>Two-tone modulation</i> .....	2.51
<b>U</b>	
<i>UCOR (level correction)</i> .....	2.47, 3.32
<i>Unit</i> .....	2.5, 3.8, 3.129
<i>Universal commands</i> .....	8C.3
<i>Useful data FLEX</i> .....	2.113
<i>User correction (UCOR)</i> .....	2.47, 3.32
<b>V</b>	
<i>VAR signal (VOR)</i> .....	2.66, 3.107
<i>VCO summing loop (calibration)</i> .....	2.159, 3.20
<i>Ventilation ducts</i> .....	1.4
<i>VHF</i> .....	2.66
<i>VIDEO output</i> .....	2.15, 2.60
<i>Voltage</i>	
<i>external modulation signal</i> .....	2.51
<i>LF output</i> .....	2.132, 3.28
<i>VOR (VHF Omnidirectional Range)</i> ...	2.65, 2.67, 3.106, 3.108
<b>W</b>	
<i>Waveform (LF generator)</i> .....	2.56, 2.58, 3.111
<i>White space</i> .....	3.11
<b>X</b>	
<i>X-AXIS output</i> .....	2.13, 2.136
<i>XMEM (memory extension)</i> .....	2.81, 3.39
<i>checksum</i> .....	3.22, 4.6
<i>sequence length</i> .....	2.83, 3.39
<i>start address</i> .....	2.83, 3.39
<i>trigger</i> .....	2.103, 3.40
<i>XY recorder</i> .....	3.103